

HICKMAN COUNTY BOARD OF EDUCATION
HCBOE Regular Meeting---April 1, 2019

The Hickman county Board of Education met on April 1, 2019, at 7:00 PM in Room 203 of the Central Office Building.

Call To Order

Approval of March 4, 2019 Regular Meeting Minutes

Approval of Agenda

Special Recognition

Employee of the Month

ACT Recognition

SCOPE Conference Recognition

4-H Governor

Haslam Scholarship

Communications to the Board

Director's Report

Financial Report

Desktop Monitoring Results

Items Requiring Board Action

Trip Requests

Textbook Adoption Approval

Budget Amendments

HICKMAN COUNTY BOARD OF EDUCATION
HCBOE Regular Meeting---April 1, 2019

Job Share Request

CIS Physical Education

EHES 2nd Grade

Capital Purchase Approval - Desktop Computers

Capital Purchase Approval - Chromebook Computers

Capital Outlay Project - Security Cameras

Revised Board Policy 6.312 (1st Reading)

Addition of Board Policy

Revised Board Policies 1.803, 4.209, 4.603 (2nd Reading)

Board Policy Review - 2.701, 2.702, 2.802, 2.803, 2.804, 2.806, 2.900

Board Policy Deletion 6.603, 6.702, 6.706 (1st Reading)

Benefits Memorandum of Understanding

Announcements

Adjourn

HICKMAN COUNTY BOARD OF EDUCATION
REGULAR BOARD MEETING---March 4, 2019

The Hickman County Board of Education met in regular session on Monday, March 4, 2019, at 7:00 p.m. in Room 203 of the Central Office building. Members present were: Chair Amy Bryant, Tim Hobbs, Ron Gammons, Jane Herron, Steve Gianakos, Vance Willis, and Jim Hudgins.

Vance Willis made a motion to approve the minutes from the board meeting on Monday, February 4, 2019. Jim Hudgins seconded the motion. On a voice vote, the motion was approved 7-0.

Jane Herron made a motion to approve the agenda. Steven Gianakos seconded the motion. The Hickman County Board of Education will meet in regular session on Monday, March 4, 2019, at 7:00 p.m. in Room 203 of the Central Office. A work session will be held in Room 203 of the Central Office at 6:00 p.m.

- I. Call to Order
- II. Approval of February 4, 2019 Regular Board Meeting Minutes
- III. Approval of Agenda
- IV. Special Recognition
- A. Employee of the Month--Steve Gianakos
- V. Communications to the Board
- A. Director's Report--Director of Schools
- B. Financial Report--Business Officer
- C. Budget Calendar--Director of Schools
- VI. Items Requiring Board Action
- A. Trip Requests--Sponsor and Students
 1. HCMS 8th Grade Class--Sponsor and Students
 2. EHHS Senior Class--Sponsor and Students
 3. HCHS FCCLA--Sponsor and Students
 4. HCHS JROTC--Instructor and Cadets
 5. EHHS FFA--Sponsor and Students
 6. HCHS FFA--Sponsor and Students
 7. EHHS HOSA--Sponsor and Students
- B. Event Requests--
 1. HCHS JROTC Adventure Camp--Instructor and Cadets
 2. HCHS JROTC Military Ball--Instructor and Cadets
- C. Budget Amendment #9 Correction--Business Officer
- D. Budget Amendments--Business Officer
- E. 2019-2020 Attendance Zones--Director of Schools
- F. Capital Project--Gym Floor Surfacing--Maintenance Director
- G. Capital Project--School Buses--Transportation Director
- H. Mowing Services--Maintenance Director
- I. Revised Board Policies (1st Reading)--Director of Accountability
- J. Board Policy Review 6.603-6.709, 1.405, 3.402--Director of Accountability
- VII. Announcements
- VIII. Adjourn

On a voice vote, the motion was approved 7-0.

Steve Gianakos read a letter recognizing Barbara Brooks as the Employee of the Month for March.

Ron Gammons made a motion to approve the Director's Report. Jim Hudgins seconded the motion.

Memorandum

To: Board Members
From: Michelle Gilbert
Date: February 22, 2019
RE: March Director's Report

Leave of Absence

Professional

Support Staff

Cynthia Monroe

FMLA (extended through March 4, 2019)

Hiring

Professional

Mary Green

EHES Interim Pre-K

Support Staff

Marcille Pence

Food Service

Misty Newcomb

EHIS Special Education Assistant

Stephanie Bodine

EHES Special Education Assistant

Laura Harris

EHIS Special Education Assistant

Ruth Gardner

HCHS Special Education Assistant

Renee Parsley

CES Bookkeeper

Resignation

Professional

Suzi Miley

EL Services

Support Staff

Wanda Beard

Food Service

Karen Mangrum

CIS Special Education Assistant

Retirement

Professional

Support Staff

Transfers

Professional

Support Staff

Appointment

Professional

Ron Gammons made a motion to accept the Financial Report as presented. Vance Willis seconded the motion. On a voice vote, the motion was approved 7-0.

The Director of Schools announced the budget calendar for the 2019-2020 school year. A budget work session will be held on March 18 at the HCHS PD Center at 6:30 p.m. and a budget work session will be held on April 1 at the Central Office building at 6:00 p.m. in Room 203.

Jim Hudgins made a motion to approve the HCMS 8th grade students to go to Beech Bend Park in Bowling Green, KY, on May 17, 2019. Steve Gianakos seconded the motion. On a voice vote, the motion was approved 7-0.

Tim Hobbs made a motion to approve the EHHS Senior Class to go to Holiday World in Santa Claus, IN, in May. Jim Hudgins seconded the motion. On a voice vote, the motion was approved 7-0.

Jane Herron made a motion to approve the HCHS FCCLA to attend State Competition in Chattanooga, TN, on March 20-22, 2019. Ron Gammons seconded the motion. On a voice vote, the motion was approved 7-0.

Ron Gammons made a motion to approve for HCHS JROTC to attend the Leadership Challenge on June 6-10, 2019, in Greenville, KY. Tim Hobbs seconded the motion. On a voice vote, the motion was approved 7-0.

Vance Willis made a motion to approve the EHHS FFA to attend State Competition in Gatlinburg, TN, on March 24-27, 2019. Ron Gammons seconded the motion. On a voice vote, the motion was approved 7-0.

Ron Gammons made a motion to approve the HCHS FFA to attend State Competition in Gatlinburg, TN, on March 24-27, 2019. Tim Hobbs seconded the motion. On a voice vote, the motion was approved 7-0.

Ron Gammons made a motion to approve the EHHS HOSA State Competition in Chattanooga, TN, on March 24-27, 2019. Jim Hudgins seconded the motion. On a voice vote, the motion was approved 7-0.

Ron Gammons made a motion to approve the HCHS JROTC Adventure Camp in Clarksville, TN, on May 20-25, 2019. Tim Hobbs seconded the motion. On a voice vote, the motion was approved 7-0.

Jim Hudgins made a motion to approve the HCHS JROTC Military Ball and Awards Night on May 4, 2019 in the gymnasium of HCHS. Steve Gianakos seconded the motion. On a voice vote, the motion was approved 7-0.

Jim Hudgins made a motion to approve the correction to Budget Amendment #9. Vance Willis seconded the motion.

<u>Aye</u>	<u>Nay</u>	<u>Pass</u>	<u>Absent</u>
Amy Bryant			
Ron Gammons			
Steve Gianakos			
Jane Herron			
Tim Hobbs			
Jim Hudgins			
Vance Willis			

On a roll call vote, the motion was approved 7-0.

Jim Hudgins made a motion to approve budget amendment #10. Steve Gianakos seconded the motion.

<u>Aye</u>	<u>Nay</u>	<u>Pass</u>	<u>Absent</u>
Amy Bryant			
Ron Gammons			
Steve Gianakos			
Jane Herron			
Tim Hobbs			
Jim Hudgins			
Vance Willis			

On a roll call vote, the motion was approved 7-0.

Vance Willis made a motion for the attendance zones to remain as established currently for the 2019-2020 school year. Ron Gammons seconded the motion. On a voice vote, the motion was approved 7-0.

Vance Willis made a motion to approve the capital project and award the gym floor bid to BAM floors for sealing except for EHES and EHHS and allocate \$26, 466.00 for sanding the gym floor at the EHHS to BAM Floors. Jim Hudgins seconded the motion.

<u>Aye</u>	<u>Nay</u>	<u>Pass</u>	<u>Absent</u>
Amy Bryant			
Ron Gammons			
Steve Gianakos			
Jane Herron			
Tim Hobbs			
Jim Hudgins			
Vance Willis			

On a roll call vote, the motion was approved 7-0.

Vance Willis made a motion to approve the capital project to purchase buses and award the bid to Central States with seat belts at \$96, 499.00 for each bus to purchase 4 buses.

<u>Aye</u>	<u>Nay</u>	<u>Pass</u>	<u>Absent</u>
Amy Bryant			
Ron Gammons			
Steve Gianakos			
Jane Herron			
Tim Hobbs			
Jim Hudgins			
Vance Willis			

On a roll call vote, the motion was approved 7-0.

Vance Willis made a motion to split the award for the mowing services bid between Petty and Sons and Three Rivers for mowing services, to be awarded for the lowest bid at each campus. Jim Hudgins seconded the motion.

<u>Aye</u>	<u>Nay</u>	<u>Pass</u>	<u>Absent</u>
Amy Bryant			
Ron Gammons			
Steve Gianakos			
	Jane Herron		
Tim Hobbs			
Jim Hudgins			
Vance Willis			

On a roll call vote, the motion was approved 6-1.

Vance Willis made a motion to approve revised board policies 1.803, 4.209, 4.603 including the addition of exceptions to include: decisions made by a student's IEP team or extenuating medical or psychological situations. Jim Hudgins seconded the motion. On a voice vote, the motion was approved 7-0.

Vance Willis made a motion to approve the review of board policies 6.603-6.709, 1.405, 3.402, as presented and for 6.709 to remain as currently stated. Jane Herron seconded the motion. On a voice vote, the motion was approved 7-0.

The meeting was adjourned at 8:16 p.m.



AMY BRYANT
9589 S. Lick Creek Rd., Lyles, TN 37098

RONALD GAMMONS
6419 Rice Ln., Lyles, TN 37098

TIM HOBBS
9220 Old Bon Aqua Rd., Bon Aqua, TN 37025

JIM HUDGINS
1297 E. Grinders Switch Rd., Centerville, TN 37033

JANE HERRON
1222 Hwy. 100., Centerville, TN 37033

STEVE GIANAKOS
9792 Dogwood Dr., Bon Aqua, TN 37025

VANCE WILLIS
2868 Hwy 48 N., Nunnely, TN 37137

Michelle Gilbert
Director of Schools
115 MURPHREE AVENUE
CENTERVILLE, TN 37033

The Hickman County Board of Education will meet in regular session on Monday, April 1, 2019, at 7:00 p.m. in the library at East Hickman High School. A work session will be held at 6:00 p.m. to discuss the 2019-2020 school budget and board agenda topics.

- I. Call to Order
- II. Approval of March 4, 2019 Regular Board Meeting Minutes
- III. Approval of Agenda
- IV. Special Recognition
 - A. Employee of the Month—Amy Bryant
 - B. ACT Recognition—High School Principals
 - C. SCOPE Conference Recognition—High School Principals
 - D. 4-H Governor—Secondary Supervisor
 - E. Haslam Scholarship—Secondary Supervisor and TNAdvise Counselor
- V. Communications to the Board
 - A. Director's Report—Director of Schools
 - B. Financial Report—Business Officer
 - C. Desktop Monitoring Results—Federal Programs Director
- VI. Items Requiring Board Action
 - A. Trip Requests—Sponsor and Students
 - B. Textbook Adoption Approval—Deputy Superintendent
 - C. Budget Amendments—Business Officer
 - D. Job Share Request—Principals and Supervisors
 1. CIS Physical Education—Principal and Supervisor
 2. EHES 2nd Grade—Principal and Supervisor
 - E. Capital Purchase Approval Desktop Computers—Technology Director
 - F. Capital Purchase Approval Chromebook Computers—Technology Director
 - G. Capital Outlay Project Security Cameras—Technology Director
 - H. Revised Board Policy 6.312 (1st reading)—Director of Schools
 - I. Addition of Board Policy —Director of Schools
 - J. Revised Board Policies 1.803, 4.209, 4.603 (2nd reading)—Director of Accountability
 - K. Board Policy Review 2.701, 2.702, 2.802, 2.803, 2.804, 2.806, 2.900—Director of Accountability
 - L. Board Policy Deletion 6.603, 6.702, 6.706 (1st reading)—Director of Accountability
 - M. Benefits - Memorandum of Understanding
- VII. Announcements
- VIII. Adjourn



AMY BRYANT
9589 S. Lick Creek Rd., Lyles, TN 37098

RONALD GAMMONS
6419 Rice Ln., Lyles, TN 37098

TIM HOBBS
9220 Old Bon Aqua Rd., Bon Aqua, TN 37025

JIM HUDGINS
1297 E. Grinders Switch Rd., Centerville, TN 37033

JANE HERRON
1222 Hwy. 100., Centerville, TN 37033

STEVE GIANAKOS
9792 Dogwood Dr., Bon Aqua, TN 37025

VANCE WILLIS
2868 Hwy 48 N., Nunnely, TN 37137

Michelle Gilbert
Director of Schools
115 MURPHREE AVENUE
CENTERVILLE, TN 37033

Memorandum

To: Board Members
From: Michelle Gilbert
Date: March 20, 2019
RE: April Director's Report

Leave of Absence

Professional

Support Staff
Alison Brady

April 1-May 21, 2019 (FMLA)

Hiring

Professional

Support Staff

Resignation

Professional

Support Staff
Kendra Beard (coaching responsibilities)

HCMS Volleyball Coach

Retirement

Professional

Support Staff

Transfers

Professional
Chris Austin

HCMS History and Assistant Football Coach to EHHS History and Head Football Coach

Support Staff

Appointment

Professional



Don Qualls
Hickman County Schools
115 Murphree Avenue
Centerville, Tennessee 37033

To: Hickman County Board of Education members

From: Don Qualls 

Date: March 21, 2019

The following textbook recommendations for adoption will be made at our April 1, 2019 school board meeting: Grades 3-8 Social Studies-Gallppade, Grades 9-12 Spanish-Wayside Publishing, Grades 9-12 Social Studies-Pearson, Grades 9-12 Economics- Pearson, Grades 9-12 Business Communications-Goodhart/Wilcox. and Computer Applications-Cengage.

Our textbooks committee has made these recommendations to me. I would agree with these selections. Thank you for your consideration.

Hickman County Board of Education
Budget Amendment No. 11
General Purpose (Fund 141)
April 1, 2019

Account	Description	Debit	Credit	Justification
141 - 73400 - 189	Other Salaries and Wages	7,300.00		
141 - 73400 - 207	Medical Insurance		7,300.00	
141 - 73400 - 399	Other Contracted Services	1,440.00		
141 - 73400 - 429	Instructional Supplies & Mat		1,440.00	Needed adjustment to Pre-K expenditures
141 - 73400 - 355	Travel	374.04		
141 - 73400 - 524	Inservice	185.48		
141 - 73400 - 198	Non-certified Substitutes		559.52	
141 - 73400 - 499	Other Supplies and Mat	1,050.00		
141 - 73400 - 790	Equipment		1,050.00	
141 - 71100 - 207	Medical Insurance	25,000.00		Additional Expenditures for Textbooks
141 - 71100 - 449	Text Books		25,000.00	
TOTALS		<u>\$ 35,349.52</u>	<u>\$ 35,349.52</u>	

Approved:

Attest:

Amy Bryant

Michelle Gilbert

Hickman County Board of Education
Budget Amendment No. 12
Food Service (Fund 143)
April 1, 2019

Account	Description	Debit	Credit	Justification
143 - 47111	USDA Lunch Program	60,000.00		To Budget for Increase Revenues and Expenditures related to Breakfast and Lunch
143 - 47113	Breakfast	60,000.00		
143 - 73100 - 422	Food Supplies		120,000.00	
TOTALS		<u>\$ 120,000.00</u>	<u>\$ 120,000.00</u>	

Approved:

Attest:

Amy Bryant

Michelle Gilbert



Hickman County Schools Board Agenda Item Request

Date: 3/11/19
Name of School: Centerville Intermediate School
Item Request: Stacy LaRue and Tara Chessor
Job Share

Explanation:

Stacy LaRue + Tara Chessor would
like to job share the CIS P.E.
position for the 2019-2020 school year.

Attachments (if necessary and appropriate):

Proposal Attached

Signature of Person requesting to be placed on the agenda:

Stacy LaRue

Signature of Building Principal or Director of Schools:

Sarah Fralery

Centerville Intermediate School
Physical Education Job Share Proposal
Stacy LaRue and Tara Chessor

Please consider our request to share the Physical Education position at Centerville Intermediate School for the 2019-2020 school year. Stacy LaRue is the current Physical Education teacher and has 11 years of teaching experience. Tara Chessor taught first grade for 8 years before staying home to care for her three sons. She has a Master's degree in Education and is certified to teach Physical Education.

Benefits of Job Sharing

- This job share would allow us to balance our teaching careers with family responsibilities. We would no longer feel like we had to choose between work and family.
- A part-time position would be less overwhelming and more enjoyable. Students would benefit from having a fresh, energetic teacher in the active setting of P.E.
- We have similar teaching styles and classroom management techniques and will follow the same schedule and daily classroom routine. We will be consistent with behavioral expectations and classroom procedures.
- Students should have no negative effects as they already rotate between teachers for classroom instruction and enrichment classes.
- We would bring two different sets of sports skills and prior knowledge to our teaching. Stacy has 11 years of experience teaching P.E. and can share strategies and ideas with Tara during collaboration. Tara played tennis for 4 years in high school, basketball for 11 years, and has a great deal of knowledge concerning the rules and skills needed for baseball and softball.
- This job share would be financially beneficial to the school system because we would not receive insurance benefits. We would also cover days for one another in the event of sickness or family emergency, which would save money needed for substitute teachers.

Scheduling

Tara would work Monday and Wednesday, while Stacy works Tuesday and Thursday. We would alternate Fridays and ensure that we each work equal days on the school calendar. We will both attend all professional development days, administrative days, and parent teacher conferences.

Planning and Communication

- We will take joint responsibility in planning lessons aligned to state standards.
- Regular communication will take place through email, texts, calls, and meetings whenever needed.
- We will keep a folder containing parent notes or concerns, behavior reports, injuries in the gym or playground, etc.

Salary

We propose to be paid half of what we would make as full time teachers according to years of experience and level of degree. We would not receive insurance benefits.

Conclusion

We appreciate your consideration of our proposed job share. In our opinion, this opportunity would be beneficial to us and our families, CIS, and the Hickman County School System. We love teaching and want to continue to educate the children of Hickman County, while spending precious time with our own children at home and during extracurricular activities.

1.403



Hickman County Schools Board Agenda Item Request

Date: 3/6/19

Name of School: East Hickman Elementary

Item Request: Job Share

Explanation:

Mrs. Knight and Mrs. Tidwell are seeking permission to continue their job share in 2nd grade at EHS for the upcoming 2019-2020 school year.

We ask that you please consider approving Mrs. Knight and Mrs. Tidwell the opportunity to continue to co-teach for the upcoming year.

Thank you for your consideration, Keisha Coble

Attachments (if necessary and appropriate):

See attachments for letter and schedule.

Signature of Person requesting to be placed on the agenda:

Jennifer Knight Mandy Tidwell

Signature of Building Principal or Director of Schools:

Keisha Coble

1.404

Request to Appear before the Hickman County Board of Education

Requests to address the Board must be made and approved a week prior to the Board meeting. If the requested topic is related to an agenda item, the remarks will be made prior to said agenda item. If the remarks are unrelated to any item on the agenda, the remarks will be placed at the end of the agenda. Speakers will be allotted five minutes to speak and must adhere to the topic declared on this request.

Name: Jennifer Knight, Mandy Tidwell, + Leegha Coble

Date Request Submitted: 3/11/19

Purpose of Request: Job Share Approval

Brief Outline of Remarks:

Mrs. Knight and Mrs. Tidwell are seeking approval to continue their job share at ~~LETTERS~~ in 2nd grade for the upcoming 2019-2020 school year.

Related Agenda Item (if applicable): _____

For office use only

Approval

Director of Schools

Date

If remarks are related to an agenda item, the remarks are to precede said agenda item; if remarks are unrelated to any agenda items, the remarks are to be placed at the end of the agenda.

February 20, 2019

To whom it may concern:

We are requesting a job share position for the 2019-2020 school year. The purpose of requesting this position is to enable us to spend more time at home caring for our young children, but also continuing to serve as an educator. We believe an equal balance between caring for our families and educating our students will benefit everyone involved. We have attached our job share proposal which includes our plan, as well as other important information regarding a job share position. We really appreciate your consideration on this matter.

Sincerely,

Mandy Tidwell

Jennifer Knight

**East Hickman Elementary School
Job Share Proposal- Mandy Tidwell and Jennifer Knight**

We have set out below our proposal to move to a job share arrangement. We wish to do so to enable us to spend a balance of time at work and at home with our young children.

Our proposal is to work in a job share arrangement beginning the 2019-2020 school year.

Advantages of Job Sharing

We would first like to highlight some advantages that we feel our proposal will bring to East Hickman Elementary School.

- The school will be able to keep/gain experienced teachers. We both have Master's Degrees in education. JK has taught 9 years and MT has taught 13 years. Hickman County Board of Education has invested money and time in training us to meet whole school initiatives and development.
- We will be working the days that best fit with our other commitments and therefore we can be more fresh, energetic, and creative during the hours that we are teaching. This can lead to improved output.
- This job share will enhance our professional life by allowing us to better balance work and family responsibilities.
- Two teachers will be involved in monitoring to ensure children achieve their full potential and progress accordingly.
- Children can benefit from being able to confide in a choice of two teachers.
- Although we have similar teaching styles and strategies, we also bring to the table different attributes, therefore reaching more students. Some students may relate better to one teacher than the other.
- We will both hold high expectations for behavior and performance and will enforce classroom rules consistently.
- We have taught 2nd grade together for 8 years so we are very familiar with each other's teaching style. JK also successfully took over maternity leave for MT.
- MT and JK successfully job shared in the 2018-2019 school year.
- Having two teachers can help prepare students for the upcoming year, wherein they may have 2 to 3 different teachers.
- Two teachers to help with fundraisers and school activities.
- School system saves money due to teachers not receiving benefits.
- We will bring two sets of skills, talents, and experience to the job. This:
 - Increases the staff resource base;
 - Supports the pooling of ideas;
 - Offers the opportunity for us to learn from one another and maintain and develop skills;
 - Maximizes individual strengths and can minimize individual weaknesses.

Working Week

We propose that we would split the working week as follows:

- Monday and Wednesday- JK
- Tuesday and Thursday- MT
- Fridays- JK and MT will alternate
- Both teachers will work the first full week of school.

Salary/Benefits

We propose to be paid according to our years experience and education just as we would in a full time position. However, we will be paid half of that of a full time teacher. As a job share employee, we will not receive benefits, which will save the school district money.

Personal and Sick Leave

We will not have any personal or sick leave days. If an emergency arises and one of us cannot be at work on our scheduled day, the other teacher will work in their place. We will just switch out days. If JK cannot work on her scheduled Monday, MT will take her place. JK will then work on MT's scheduled Tuesday or Thursday. This way our days will stay even and we can save the school district money by not having to pay a substitute teacher.

Responsibilities for Curriculum, Assessment, and Planning

We will take joint responsibility for planning our lessons to align with TN state standards.

We will plan for the week ahead together.

We will ensure that assessment and record keeping are done the same by each teacher.

Liaison

We will maintain a class liaison file detailing incidents, parent communication, etc. for reference during the week to provide continuity. This would include a seating chart, medical notes, behavior issues, and student information.

We will both use the same Class Dojo account. Each of us will be able to get notifications of behavior and parent communications so that we are always in the loop.

Faculty and Committee Meetings

The teacher who is working on the meeting day will share all information with the other.

Professional Development and Administrative Days

We will both attend all professional development and administrative days. We will both complete all professional development online training sessions. We will both attend the PD Summit.

Parent Teacher Conferences

We will both attend all parent teacher conferences as scheduled by the district.

IEP/S-Team/RTI Meetings

Whichever teacher is working on the scheduled meeting day will attend and provide all information to the teacher not in attendance.

More Information on how we intend to work together to make the arrangement work

To ensure this is an effective job share arrangement we would:

- Communicate regularly with each other using a communication book and also through emails, texts, phone calls, and meetings. This will be important if issues arise with children or if there are any parental concerns at anytime. This will ensure continuity and consistency, particularly where behavior is concerned;
- Plan together at the beginning of each 9 weeks and also weekly for the upcoming week.
- Meet regularly to discuss targets and standards of children's progress and discuss next steps;
- Where possible, ensure that any problems that arise are resolved by the end of the day so that the other teacher does not have to deal with them the next day.

Review of the Job Share Arrangement

We understand that the renewal of a job share position must be reviewed and approved each year by our principal, superintendent, and the school board.

COPY

Invitation to Bid

The Hickman County Finance Office is accepting sealed bids for Desktop Computers & Monitors.

Bid with specifications are online at: www.hickmank12.org/request-for-proposal.

Sealed bids must be mailed or delivered to the Hickman County Finance Office, 114 North Central Avenue, Suite 203, Centerville, TN 37033 and clearly marked on the outside of the envelope "Desktop Computers & Monitors". Bids will be opened on Monday, March 4th, 2019 at 10:00 a.m. in the Finance Office. The Hickman County Board of Education reserves the right to accept or reject any and all bids or parts of bids and to waive any informalities that would prevent the acceptance of a better bid.

President Remy Mayberry
Carroll Davis

	Computer		Monitors	
		Refurb.	Refurb	New
STS	251.00		42.00	104.00
System Liquidation	239.00		69.00	49.00 109.00
2nd Gear	259.00 303.00 399.00		70.00	
CDI	259.00 265.00			
Coretex	189.00		80.00	
BGC	298.00		89.00	

Bringing the Future of Education Technology to Students Today

Prepared for:

Hickman County Schools



Desktop Computers and Monitors

Proposal & Statement Of Work

March 2019



COMPANY OVERVIEW

STS Education is a technology solutions company located in Southern California with distribution facilities throughout the US. For more than 15 years STS has been providing the right technology for less money to K-12 schools and has been recognized by Inc. Magazine as one of the fastest growing privately-held companies since 2012. From Second-Life Hardware™ with a lifetime parts warranty to complete IT and Network Management solutions, STS is an upcoming industry leader with a foundation built on legendary customer service.

The roots of STS started in 2001 when then EduTech began providing schools with reconditioned computers in response to a California state initiative that granted technology funding to high schools. In 2010 EduTech merged with Pacific OneSource, under a unified goal to provide cost-effective technology solutions to classrooms nationwide. Today, STS Education is an Ed-tech company that has a curated set of purpose-built for education products, services and solutions that revolve around four areas, Operational Sustainability, Collaboration and Engagement, STEAM and Software.



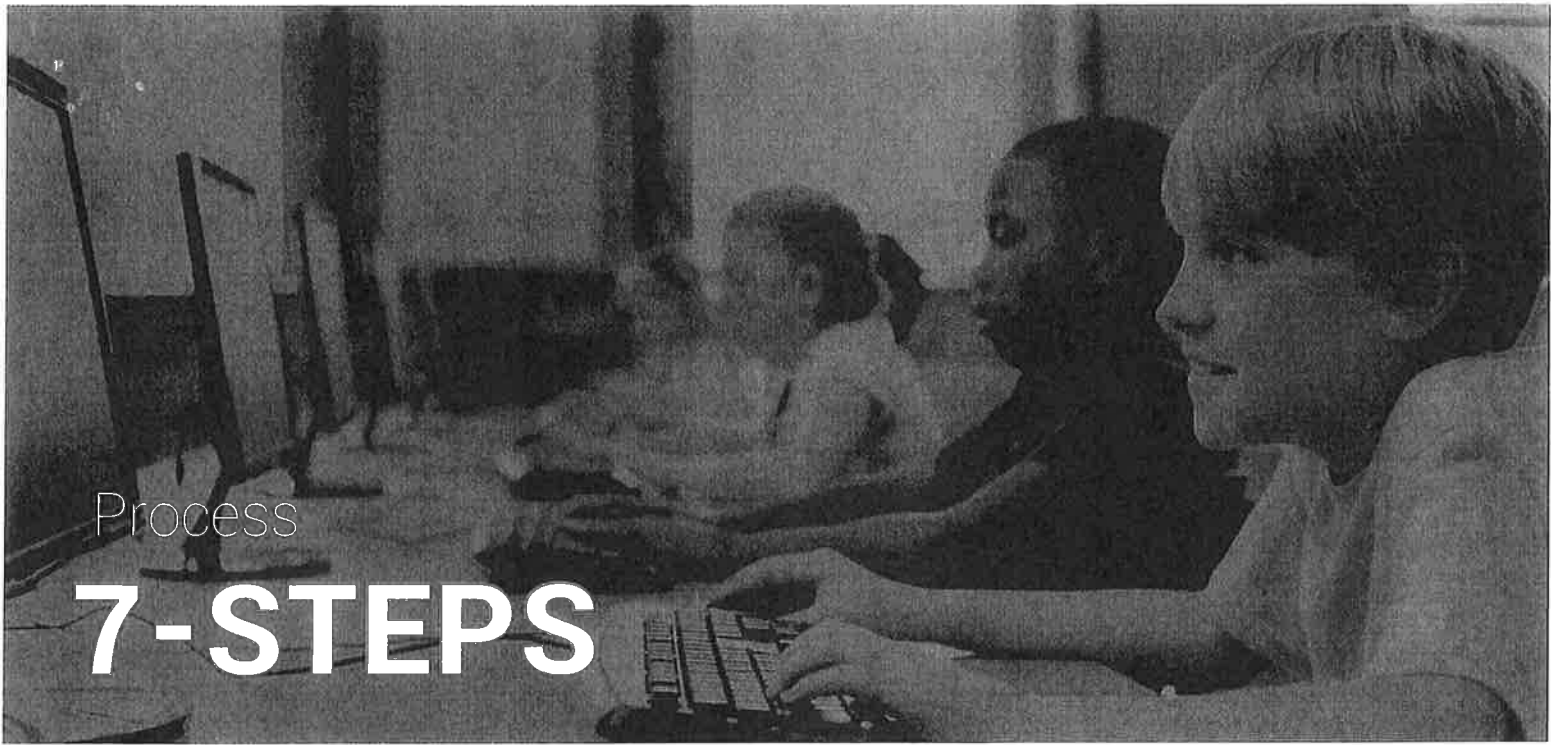

Process
7-STEPS

STS only procures inventory of the highest quality. The hardware is from clean corporate environments at the end of a lease. Every machine is put through a vigorous 7-step inspection and performance testing process at our Microsoft-Registered facility. Those machines that pass the inspection are customized to meet the receiving school's specifications.



Initiative Details

HARDWARE

Dell 7010 SFF
Desktop-
Refurbished

Basic Specifications:

- Core i5 Processor
- 8GB RAM
- 128 GB SSD
- Dual Video Card (HDMI/VGA)
- Logitech Keyboard/Mouse Included
- Windows 10 Pro OS (MAR)
- Custom Image from the District
- Lifetime Parts Warranty



Basic Specifications:

- 22" LCD Screen

Dell 22" LCD
Monitor-
Refurbished

HP 23.8" LED
HP N246v
Monitor- NEW

Basic Specifications:

- 23.8" LED Screen
- 1920 x 1080 Full HD
- HDMI and VGA input
- 3 Year Manufacturer Warranty



	Price/Unit	TOTAL
Dell OptiPlex SSF 7010 Desktop- Refurbished (75)	\$251.00	\$18,825.00
Dell 22" LCD Monitor- Refurbished Option (75)	\$42.00	\$3,150.00
HP 23.8" LED Monitor- NEW Option (75)	\$104.00	\$7,800.00
Freight	\$2,000.00	
TOTAL W/Refurbished Monitors		\$23,975.00
TOTAL W/New Monitors		\$28,625.00

Pricing Valid Through June 13th, 2019



The Right Technology



Shawn Runner | Sales Operations Coordinator
866-499-2580 • shawn.runner@stseducation-us.com

www.STSEducation-US.com

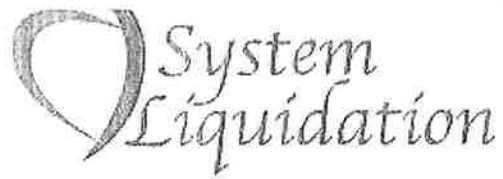

Desktop Computers & Monitors Bid

Index

Page 1-4. Cover Letter.

Page 5. Quotation Form And Description Option 1

Page 6. Quotation Form And Description Option 2

Page 7. Quotation Form And Description Option 3

Page 8. Warranty Policy.

Page 9. Product preparation and testing.

System Liquidation Inc
1652, South 2ND Street
Plainfield, NJ 07061
Ph: 908-668-0008
Fax: 908-668-0088
Contact: Ken



①

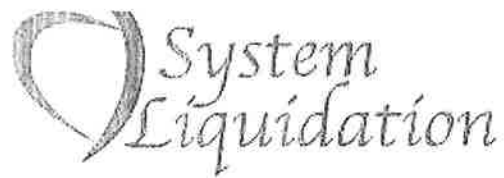

Company Overview

System Liquidation . is North America's leading provider of refurbished information technology equipment. A Microsoft Authorized Gold Certified Partner and Refurbisher, we have access to millions of dollars of IT products from Tier 1 vendors like: HP, Dell, IBM, Lenovo, Samsung, and others. We have 2 warehouses-One 20,000 square foot located in New jersey and 2nd 75,000 square foot located in Ontario, Canada. We manage and maintain 7 Million **dollar Inventory** located in our warehouse. We sell our top quality equipment to many vertical including: Government, Education, Healthcare, Manufacturers and Value Added Resellers. System Liquidation Inc offers a strategic approach to information technology resource management and provides a cost effective IT solution to today's demanding marketplace. System Liquidation understands that corporate capital expenditures are continuously constrained by the ever changing economic IT marketplace.

Company Strategy and Mission

Through an efficient and diversified multi-channel marketing system, we provide customers a unique shopping experience by offering the best prices and great service on a broad selection of products and services. The mission of System Liquidation is to provide our customers with strategic cost effective quality solutions to help resolve the continually evolving budgetary challenges associated with today's information technology.

Business Scope

Asset Disposition planning is at the core of our business model. We help our partners with the safe and environmentally conscious removal of IT equipment as their technology needs evolve. Further, as much of this equipment continues to retain value, it is our goal to allocate top value to these devices toward the purchase of newer, current, and relevant IT devices.

System Liquidation Inc
1652, South 2ND Street
Plainfield, NJ 07061
Ph: 908-668-0008
Fax: 908-668-0088
Contact: Ken



②

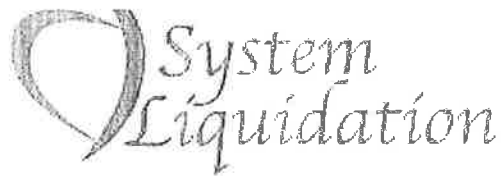

Background and Workforce

System Liquidation founded in 2007 Plainfield NJ. System Liquidation and their sister company employs over 100 individuals who have a wide range of industry certification including: MCSE's, CCNA's and A+. The number is expected to increase in the coming years. In addition to, our employee collectively has many years of relevant work experience with professional relationships within a multitude of industries. Our staff is also able to communicate in over 10 languages. This talented group of people possess post-secondary education in many fields including; Business, Computer Science, and Electronic Engineering.

System Liquidation are dedicated to continuous measurable improvement in all our activities, which meet our customer requirements. Honesty and trust and mutual respect will be the basis for all dealings with our associates, customers, suppliers and society at large. We will constantly strive to be the industry's best suppliers of high quality products and services. We are committed to the continuous improvement of all that we offer our clients.

Trust

We trust our customers implicitly and run our company accordingly. A good example is our warranty policy. When a customer needs to fulfill warranty, we no longer have to verify whether they are at fault or retrieve the damaged equipment first. Our clients simply tell us what parts are needed and we ship them. This way of thinking permeates through everything we do and the end result is that you never have to fight us to do what you want—we're always on the same side.

System Liquidation Inc
1652, South 2ND Street
Plainfield, NJ 07061
Ph: 908-668-0008
Fax: 908-668-0088
Contact: Ken



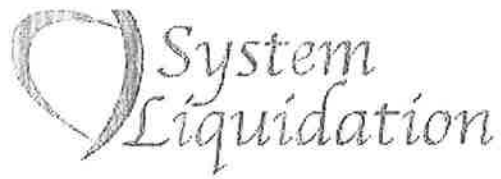

Financial And Business Viability

System Liquidation Inc. confirms that we have not:

- a) Declared bankruptcy or made a voluntary assignment in bankruptcy;
- b) Made a proposal under any legislation related to bankruptcy or insolvency; or,
- c) Been subject to or instituted any proceedings, arrangement, or compromise with creditors including having had a receiving and/or manager appointed to hold its assets.

Proof Of Insurance

System Liquidation Inc. confirms that we are able to obtain Insurance Coverage for this assignment.

Deliverables

System Liquidation Inc. confirms that we can complete and execute the Deliverables outlined in our submission document.

Non-Collusion

System Liquidation Inc. certifies that this proposal is made without any previous understanding, agreement or connection with any person, firm, or corporation making a proposal for the same project, and is in all respects fair, without outside control, collusion, fraud, or otherwise illegal action.

Bid Compliance

System Liquidation Inc. has complied with all bid requirements and agrees to the terms and conditions as outlined in the bid document.

Willingness To Enter Into Agreement

System Liquidation Inc. confirms that we are prepared to enter into an agreement with the "Scottsdale Unified School District". Should our proposal be accepted, contracts will be signed by Rohit Gera, Sales Manager.

System Liquidation Inc
1652, South 2ND Street
Plainfield, NJ 07061
Ph: 908-668-0008
Fax: 908-668-0088
Contact: Ken

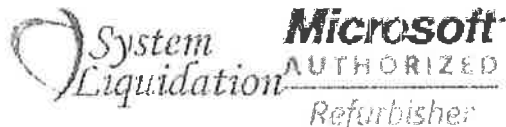

Hickman County school System Desktop Computers and Monitors

Option 1: Dell Optiplex 7010 SFF

Model	Dell Optiplex 7010 SFF
Processor	Intel Core i5-3470 3.2GHz 3rd Gen
Ram	8GB DDR3 Ram
Video	EVGA GF 210 MODEL # 01G-P3-1313-KR
Sound	On-Board
Hard Drive	240GB Solid State Hard Drive
Optical Drive	DVD +/-RW
Network	10/100/1000 Onboard NIC)
Operating System	Windows 10 Pro 64-Bit
Warranty	5 year on system. Video card carries manufacturer Warranty
Price	\$239 Each



System Liquidation
1652, South 2nd Street
Plainfield, NJ ;07063

System Liquidation Inc
1652, South 2ND Street
Plainfield, NJ 07061
Ph: 908-668-0008
Fax: 908-668-0088
Contact: Ken

System Liquidation **Microsoft**
AUTHORIZED
Refurbisher



System Liquidation
1652, South 2nd Street
Plainfield, NJ ;07063

Hickman County school System
Desktop Computers and Monitors

Option 2: HP Elitedesk 800 G1 SFF

Model	HP Elitedesk 800 G1 SFF
Processor	Intel Core i5-4570 3.2GHz
Ram	8GB DDR3 Ram
Video	EVGA GF 210 MODEL # 01G-P3-1313-KR
Sound	On-Board
Hard Drive	240GB Solid State Hard Drive
Optical Drive	DVD +/-RW
Network	10/100/1000 Onboard NIC)
Operating System	Windows 10 Pro 64-Bit
Warranty	5 year on system. Video card carries manufacturer Warranty
Price	\$249 Each

System Liquidation Inc
1652, South 2ND Street
Plainfield, NJ 07061
Ph: 908-668-0008
Fax: 908-668-0088
Contact: Ken

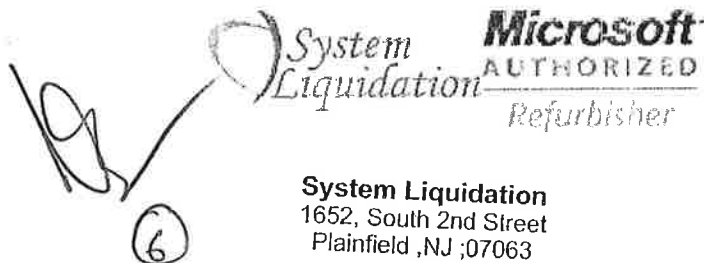

Hickman County school System
Desktop Computers and Monitors

Option 3: MONITORS

Model	DELL P2214H
Screen Size	22"
Warranty	5 years
Price	\$69
Includes	VGA cable and Power cord

Model	HP LE2002XM
Screen Size	20"
Warranty	5 years
Price	\$49
Includes	VGA cable and Power cord

Model	HP ZR24W
Screen Size	24"
Warranty	5 years
Price	\$109
Includes	VGA cable and Power cord

System Liquidation Inc
1652, South 2ND Street
Plainfield, NJ 07061
Ph: 908-668-0008
Fax: 908-668-0088
Contact: Ken

System Liquidation **Microsoft**
AUTHORIZED
Refurbisher



System Liquidation
1652, South 2nd Street
Plainfield, NJ 07063

Warranty Policy

System Liquidation Inc Re-Certified computers are scrutinized closely prior to shipment that we include a **5 Years parts replacement Warranty** on all of our fully Re-Certified Desktops.

No matter how good our hardware, or how thorough our process, a small percentage of our units will have "issues" during the course of the warranty period. If you do experience any trouble with your hardware, and your equipment is within the original warranty period, the process is simple: You call us or e-mail us – your choice.

If you call during our standard business hours of 9:30am to 5:30pm Eastern Time, you will be greeted by a live person and transferred to a technician dedicated to resolving your issue. You will be walked through a series of very basic steps to qualify and diagnose your specific issue. If it is determined that a replacement part is required, the replacement part will generally ship that same day.

When a warranty part is needed, a school staff member can contact either sales rep or their support staff for obtaining items needed. The communication can be via email or phone. To obtain a warranty part, provide the part needed along with the service tag on the machine that needs a replacement and the part will be sent out to the school at the address requested. Parts are usually shipped in 48 hrs,
We pay for shipping both ways.

System Liquidation inc also offers the option of providing the school with buffer stock units, so that they can swap the units on-site. This can be discussed with your sales rep.

Customer support: Call 1-888-714-1545 Or Email tech@systemliquidation.com

System Liquidation Inc
1652, South 2ND Street
Plainfield, NJ 07061
Ph: 908-668-0008
Fax: 908-668-0088
Contact: Ken

 **Microsoft**
AUTHORIZED
Refurbisher

Product Preparation and Testing

All our products are originated from end of the lease corporate customers, ensuring they are the highest quality corporate grade models from clean office environments.

1. **Asset Tag**
Every computer gets a unique asset tag number. This number is labeled, bar coded and scanned into our system allowing us to track every single component, every technician who tested it and other pertinent information (service work, custom upgrades, quality assurance, etc.)
2. **Power up tests**
All the units we receive are powered up to make sure no immediate and obvious failures occurred during receiving.
3. **Dust Removal**
Cases are removed and our state of the art dust containment station uses a combination of pressurized air and suction system to remove every bit of dust from within the unit, including such hard to reach places as power supply and CPU fans.
4. **Surface Cleaning**
Using non-toxic, environmentally friendly cleaners our cleaning team cleans all external surfaces. Specialized chemicals are used for specific cleaning tasks (sticker glue removed, general cleaning, etc.)
5. **Total Cleaning**
Individual techs hand clean each unit, paying special attention to hard to reach places as well as any grime missed by the surface cleaners.
6. **Component Check**
Using custom diagnostic software each unit connects to our testing server where every single component is checked and verified. This both ensures that components are all working and that the unit has the same original components it was manufactured with (for proper imaging).
7. **Windows Driver Test**
Units are plugged in and allowed to boot up fully to windows. Every driver is checked to make sure there are no conflicts or invisible hardware. Basic functions are tested as is the fidelity of the custom image. Units that pass the above tests are placed on the shelf ready for sale
8. **Custom Imaging (Upon Request)**
Custom imaging is done on customer's request.

System Liquidation Inc
1652, South 2ND Street
Plainfield, NJ 07061
Ph: 908-668-0008
Fax: 908-668-0088
Contact: Ken



PART B

SPECS FOR DESKTOP COMPUTERS

Windows 10 64-bit Professional Operating System

HP or Dell preferred but other brands will be considered

SFF preferred

4 GB memory minimum

128 SSD minimum

Secondary Video Card Supporting Dual Displays With VGA and HDMI Out (EVGA Brand Preferred, Fan-less Preferred)

Headphone Jack

Refurbished computers with 3-5 year replacement warranty will be considered

Delivery will be at the location requested by Hickman County Schools.

Minimum 75 computers will be ordered with more possible.

Bid price shall be good through June 13th, 2019.

Contact Brad Gilbert at 931-729-3391 Ext. 2229 if you need more information.

MONITORS

HP or Dell preferred but other brands will be considered.

20" – 23" inch screen size preferred

HD resolution preferred

Bid price shall be good through June 13th, 2019.

Contact Brad Gilbert at 931-729-3391 Ext. 2229 if you need more information.

Rep Contact Info:

Carl Martin
Account Executive
2NDGEAR
1818 Pot Spring Road, Suite 102
Lutherville, MD 21093
Phone:410-513-7623
Fax:443-588-0888
cmartin@2ndgear.com

Bill To:

Attn: Brad Gilbert
Hickman County BOE
115 Murphree Avenue
Centerville, TN 37033
Phone: (931) 729-6124

Remit To:

2NDGEAR
Accounts Receivable
611 Anton Blvd, Ste 700
Costa Mesa, CA 92626

Qty	Mfr	Description	Limited Warranty	Unit Price	Ext Price
1	HP	EliteDesk8300, SFF, ICI5-3.20GHZ(3470), 4GB RAM,1GB VC (VGA,DVI,HDMI) 128GB SSD, DVD, W10Pro RRP 64-bit, New KB/Mouse	3-Year Advance Replacement Warranty	\$259.00	\$259.00
		Optional Upgrades: 4GB RAM (8GB total)-\$30 256GB SSD-\$15 5 year advance replacement warranty-\$15 6 year advance replacement warranty-\$18			

Limited Warranty Period(s): As specified above.

Freight ID: _____ Inc

Subtotal: _____ \$259.00

Shipping: _____ \$0.00

Estimated Tax: _____ Per State

Total Purchase: _____ \$259.00

Delivery Terms: 2 weeks after acceptance of order by 2NDGEAR

Freight Terms: FCA Origin

Proposal Expiration Date: While Quantities Last

Payment Terms: Net 30 from 2NDGEAR's issuance of invoice

The price shown includes a 3% discount for payments made by cash, check or wire transfer.

If payment is made by credit card, or through a third party payment processor, the 3% cash discount will not be available.

Additional Comments:

Agreed to and Accepted by:

Signature: _____
Name: _____
Title: _____
Date: _____
PO#: _____

Ship To:

The Sales terms and Limited Warranty terms governing this Proposal can be found at:

[2NDGEAR Sales Agreement Terms and Conditions](#)

[2NDGEAR Advance Replacement Warranty](#)

Rep Contact Info:

Carl Martin
Account Executive
2NDGEAR
1818 Pot Spring Road, Suite 102
Lutherville, MD 21093
Phone:410-513-7623
Fax:443-588-0888
cmartin@2ndgear.com

Bill To:

Attn: Brad Gilbert
Hickman County BOE
115 Murphree Avenue
Centerville, TN 37033
Phone: (931) 729-6124

Remit To:

2NDGEAR
Accounts Receivable
611 Anton Blvd, Ste 700
Costa Mesa, CA 92626

Qty	Mfr	Description	Limited Warranty	Unit Price	Ext Price
1	HP	EliteDesk 800 G1, SFF, IC5-3.2GHZ(4570), 4GB RAM, 1GB VC (VGA,DVI,HDMI) 128GB SSD, DVD, W10Pro RRP 64-bit, New KB/Mouse	3-Year Advance Replacement Warranty	\$303.00	\$303.00
		Optional Upgrades: 4GB RAM (8GB total)-\$30 256GB SSD-\$15 5 year advance replacement warranty-\$15 6 year advance replacement warranty-\$18			

Limited Warranty Period(s): As specified above.

Freight ID:	Inc
Subtotal:	\$303.00
Shipping:	\$0.00
Estimated Tax:	Per State
Total Purchase:	\$303.00

Delivery Terms: 2 weeks after acceptance of order by 2NDGEAR

Freight Terms: FCA Origin

Proposal Expiration Date: While Quantities Last

Payment Terms: Net 30 from 2NDGEAR's issuance of invoice
The price shown includes a 3% discount for payments made by cash, check or wire transfer.
If payment is made by credit card, or through a third party payment processor, the 3% cash discount will not be available.

Additional Comments:

Agreed to and Accepted by:

Signature: _____
Name: _____
Title: _____
Date: _____
PO#: _____

Ship To:

The Sales terms and Limited Warranty terms governing this Proposal can be found at:

[2NDGEAR Sales Agreement Terms and Conditions](#)

[2NDGEAR Advance Replacement Warranty](#)

2NDGEAR: 7012 Belgrave Ave. Garden Grove, CA 92841- US.



An Insight Investments Company

Account Name	Proposal Number	Date
Hickman County BOE (HIC04)	QUO-48167-B5D3T0	2/28/2019

Rep Contact Info:

Carl Martin
Account Executive
2NDGEAR
1818 Pot Spring Road, Suite 102
Lutherville, MD 21093
Phone:410-513-7623
Fax:443-588-0888
cmartin@2ndgear.com

Bill To:

Attn: Brad Gilbert
Hickman County BOE
115 Murphree Avenue
Centerville, TN 37033
Phone: (931) 729-6124

Remit To:

2NDGEAR
Accounts Receivable
611 Anton Blvd, Ste 700
Costa Mesa, CA 92626

Qty	Mfr	Description	Limited Warranty	Unit Price	Ext Price
1	DELL	Dell OptiPlex 9020, SFF, IC15-3.2GHZ (4570), 8GB RAM, 1GB VC (VGA,DVI,HDMI) 128GB SSD, DVD, W10Pro RRP 64-bit, New KB/Mouse	3-Year Advance Replacement Warranty	\$339.00	\$339.00
		Optional Upgrades: 256GB SSD-\$15 5 year advance replacement warranty-\$15 6 year advance replacement warranty-\$18			

Limited Warranty Period(s): As specified above.

Freight ID:	Inc
Subtotal:	\$339.00
Shipping:	\$0.00
Estimated Tax:	Per State
Total Purchase:	\$339.00

Delivery Terms: 2 weeks after acceptance of order by 2NDGEAR

Freight Terms: FCA Origin

Proposal Expiration Date: While Quantities Last

Payment Terms: Net 30 from 2NDGEAR's issuance of invoice
The price shown includes a 3% discount for payments made by cash, check or wire transfer.
If payment is made by credit card, or through a third party payment processor, the 3% cash discount will not be available.

Additional Comments:

Agreed to and Accepted by:

Signature: _____
Name: _____
Title: _____
Date: _____
PO#: _____

Ship To:

The Sales terms and Limited Warranty terms governing this Proposal can be found at:

2NDGEAR Sales Agreement Terms and Conditions

2NDGEAR Advance Replacement Warranty

2NDGEAR: 7012 Belgrave Ave. Garden Grove, CA 92841- US.

Rep Contact Info:

Carl Martin
Account Executive
2NDGEAR
1818 Pot Spring Road, Suite 102
Lutherville, MD 21093
Phone:410-513-7623
Fax:443-588-0888
cmartin@2ndgear.com

Bill To:

Attn: Brad Gilbert
Hickman County BOE
115 Murphree Avenue
Centerville, TN 37033
Phone: (931) 729-6124

Remit To:

2NDGEAR
Accounts Receivable
611 Anton Blvd, Ste 700
Costa Mesa, CA 92626

Qty	Mfr	Description	Limited Warranty	Unit Price	Ext Price
1	DELL	20", WIDE, VGA cable LCD Options: 22" Dell/HP-\$86 23" HP-\$99 24" HP-\$102	3-Year Advance Replacement Warranty	\$70.00	\$70.00

Limited Warranty Period(s): As specified above.

Freight ID:	Inc
Subtotal:	\$70.00
Shipping:	\$0.00
Estimated Tax:	Per State
Total Purchase:	\$70.00

Delivery Terms: 2 weeks after acceptance of order by 2NDGEAR

Freight Terms: FCA Origin

Proposal Expiration Date: While Quantities Last

Payment Terms: Net 30 from 2NDGEAR's issuance of invoice
The price shown includes a 3% discount for payments made by cash, check or wire transfer.
If payment is made by credit card, or through a third party payment processor, the 3% cash discount will not be available.

Additional Comments:

Agreed to and Accepted by:

Signature: _____
Name: _____
Title: _____
Date: _____
PO#: _____

Ship To:

The Sales terms and Limited Warranty terms governing this Proposal can be found at:

[2NDGEAR Sales Agreement Terms and Conditions](#)

[2NDGEAR Advance Replacement Warranty](#)

2NDGEAR: 7012 Belgrave Ave. Garden Grove, CA 92841- US.



**Hickman County Schools
Desktop Bid**

Refurbished HP 6300 Small Form Factor

Specifications:

Processor: Intel Core i5-3470

RAM: 4GB

Hard Drive: 128GB SSD

Optical Drive: DVD ROM

Video Card: EVGA GeForce 210 PCI Express 2.0 Fan-less DVI/HDMI/VGA (**Brand New**)

Operating System: Windows 10 Professional 64-bit

Warranty: 5 Year Spare-In-The-Air Advanced Replacement Warranty (**See Attached**)

Ports: USB and Headphone

See Attached Sheet for White-Glove Delivery and Warranty Details

Total Unit Cost: \$298.00

(unit pricing includes shipping/freight)

Price Guaranteed from March 4th, 2019 until June 13th, 2019



**Hickman County Schools
Monitor Bid**

Brand-New HP 21.5" WLED LCD Monitor

Specifications:

LCD Size: 21.5"

Color Supported: 16.7 Million

Contrast Ratio: 10,000,000: 1

Resolution: 1920 x 1080

Energy Star: Yes

Screen Mode: Full HD

IO Ports: HDMI, VGA

Warranty: 3 Year Limited Warranty

Total Unit Cost: \$89.00

(unit pricing includes shipping/freight)

Price Guaranteed from March 4th, 2019 until June 13th, 2019



Services Included in Unit Pricing

- ✚ The refurbished desktops will come with a 5-Year Spare-In-The-Air Advanced Replacement Warranty. If and when the school experiences issues with any of the equipment, BGCSYSTEMS will dispatch a replacement unit to the school to go in place prior to the old unit being removed. That way, staff will not be forced to go without a working unit at any given time. Shipping will be paid by BGCSYSTEMS in both directions if personal delivery of the unit is not otherwise made. The school has the option to request part replacement instead of the entire unit replacement in any case in which that is preferred.
- ✚ Computers will be delivered by BGCSYSTEMS with White-Glove service. Units will be unboxed, wired into their permanent location, and joined to the school domain. The old computer will also be removed and placed in designated area as per school instructions.
- ✚ Computers will be imaged and setup prior to delivery as per request of the school's technology coordinator. Windows will be full updated with basic applications (Chrome, Java, Adobe) installed and configured. Additional requests made for the images by the technology coordinator will be administered prior to delivery, as well.

All Terms and Conditions are accepted as printed in the schools Invitation to Bid.

BGCS is a registered company, licensed to do business in Hickman, Co. TN with a valid Hickman Co. Business License. No subcontractors will be used.

- 16) Warranty/Service Experience: School District. may request warranty service through our help desk at (877) 909-0515, by emailing max@bgcsystems.com or by submitting a warranty ticket at the BGCSystems Online Client Portal. BGCSystems will work directly with the manufacture to provide warranty assistance. School District will NOT have to call manufacture directly for any type of support, however, a toll free support line to each manufacture will be made available to the district if the district wishes.
- 17) Vendor Help Desk: BGCSystems Help Desk is available from 8am to 5pm Monday- Friday at (877) 909-0515. Additional time may be requested at no additional charge for after hour or weekend support. The BGCSystems Online Client Portal will be available to the district 24 hours a day, 7 days a week. The Client Portal will allow for warranty tickets to be created, help desk (general questions) tickets to be created and provide a custom knowledgebase of articles pertaining to products owned by the school district.
- 18) BGCSystems has provided detailed explanation of compliance of bid specification on this document, however in addition, BGCSystems provides a blanket compliance of all bid specifications as outlined in the bid packet.
- 19) BGCSystems agrees to purchase and secure and bid, performance, and/or payment bonds as requested by school district.
- 20) Please consider our services, listed below, that are included free of charge in each of our bid prices.



Services Included in Unit Pricing/Notes to Bid

Technical Acknowledgements/ Notes

Chromebooks- BGCSYSTEMS will providing the following services for Chromebook purchases

- a. "White Glove" service to include enrollment, asset tag placement, and Chromebook Management Sub Organization creation
- b. Warranty Support to allow the district to request service from BGCSYSTEMS directly for all warranty needs.
- c. Onsite Delivery, Installation, and trash removal provided by BGCSYSTEMS staff member.

Computer Systems (Desktops and Laptops) BGCSYSTEMS will providing the following services for Computer Systems purchases

- d. "White Glove" service to include domain join, asset tag placement, and full system imaging. System imaging to include imaging per direct specification of technology coordinator.
- e. Warranty Support to allow the district to request service from BGCSYSTEMS directly for all warranty needs.
- f. Onsite Delivery, Installation, and trash removal provided by BGCSYSTEMS staff member.



Connect. Deploy. Inspire.

Section 1

CDI Quotes



130 South Town Centre Blvd.
 Markham, ON L6G 1B8
 1-888-226-5727
 cditechnologies.com

Quote

Customer: Hickman County Schools
Contact: Brad GILBERT
Quote: 1069550
Date: 25-Feb-2019
Expiry Date: 28-Mar-2019

BARRY MASTERS x3892
 bmasters@cditechnologies.com

Invoice To:

Hickman County Schools
 Brad GILBERT
 115 Murphree Ave

 Centerville
 TN, USA 37033
 Phone: 9317293391

Ship To:

HICKMAN CO SCHOOL DISTRICT
 Brad GILBERT
 115 Murphree Ave

 Centerville
 TN, USA 37033
 Phone: (931) 729-3391

PO Number: Tax Exempt ID: 626000673 Entered By: BARRY MASTERS

No	SKU#	Item Description	Notes	Unit Price	Qty	Ext Price
1		HP,ELITE 8300, SFF, I5 3470, 3.2 GHZ, DDR3, 4.0 GB, 120 GB SSD, DVD, GB NIC	1GB EVGA CARD FANLESS 5 YEAR WARRANTY WIN 10 PRO 64 BIT	\$259.00	75	\$19,425.00
2	232881	CDI Recertified Keyboard Kit		\$0.00	75	\$0.00
3	287000	Bulk pack PC 6 per box		\$0.00	75	\$0.00
4	288379	Windows 10 Professional QLF-00574		\$0.00	75	\$0.00
5		SKU 84106-5 YEAR PREMIUM EXTENDED WARRANTY (COMPUTER)		\$0.00	75	\$0.00
6	187302	,NEW,EVGA,210 SDDR3 1GB D+V+HDMI with Low Profile bracket	Fanless heatsink, Nvidia CUDA technology, Nvidia PureVideo HD technology, Nvidia PhysX-Ready, HDCP	\$0.00	75	\$0.00
7	310034	Generic, 120GB SSD SOLID STATE HARD DRIVE, 2.5"		\$0.00	75	\$0.00
8	282552	GENERIC 2.5" to 3.5" MOUNTING BRACKET WITH SCREW FOR SSD		\$0.00	75	\$0.00
9	73713	UPGRADE CHARGE (PER UNIT)		\$0.00	75	\$0.00
10		HP,ELITE 8300, SFF, I5 3470, 3.2 GHZ, DDR3, 8.0 GB,120 GB SSD, DVD, GB NIC	Same specifications with 8gb ram & 120gb ssd	\$276.00	75	\$20,700.00
11		HP,ELITE 8300, SFF, I5 3470, 3.2 GHZ, DDR3, 4.0 GB, 240 GB SSD, DVD, GB NIC	Same specifications with 240gb ssd	\$269.00	75	\$20,175.00
12		HP,ELITE 8300, SFF, I5 3470, 3.2 GHZ, DDR3,8.0 GB, 240 GB SSD, DVD, GB NIC	Same specifications with 8gb ram & 240gb ssd	\$287.00	75	\$21,525.00
13	296839	HP,LA2006x, VGA & DVI & DISPLAYPORT, 20W LCD, Black, REGULAR STAND Already Boxed Product 5 YEAR LCD Warranty	or equivalent. 5 year warranty	\$71.00	75	\$5,325.00
14	356837	HP,ELITEDISPLAY E221C, VGA & DVI & DISPLAYPORT, 22W LCD, Black, REGULAR STAND Already Boxed Product 5 YEAR LCD Warranty	or equivalent. 5 year warranty	\$88.00	75	\$6,600.00



130 South Town Centre Blvd.
 Markham, ON L6G 1B8
 1-888-226-5727
 cditechnologies.com

Quote

Customer: Hickman County Schools
Contact: Brad GILBERT
Quote: 1069386
Date: 22-Feb-2019
Expiry Date: 28-Mar-2019

BARRY MASTERS x3892
 bmasters@cditechnologies.com

Invoice To:

Hickman County Schools
 Brad GILBERT
 115 Murphree Ave

 Centerville
 TN, USA 37033
 Phone: 9317293391

Ship To:

HICKMAN CO SCHOOL DISTRICT
 Brad GILBERT
 115 Murphree Ave

 Centerville
 TN, USA 37033
 Phone: (931) 729-3391

PO Number: Tax Exempt ID: 626000673 Entered By: BARRY MASTERS

No	SKU#	Item Description	Notes	Unit Price	Qty	Ext Price
1		DELL, OPTIPLEX 7010, SFF, I5 3470, 3.2 GHZ, 4.0 GB, 120GB SSD, DVD	1GB EVGA CARD FANLESS 5 YEAR WARRANTY WIN 10 PRO 64 BIT	\$265.00	75	\$19,875.00
2	232881	CDI Recertified Keyboard Kit		\$0.00	75	\$0.00
3	287000	Bulk pack PC 6 per box		\$0.00	75	\$0.00
4	288379	Windows 10 Professional QLF-00574		\$0.00	75	\$0.00
5		SKU 84106-5 YEAR PREMIUM EXTENDED WARRANTY (COMPUTER)		\$0.00	75	\$0.00
6	187302	,NEW,EVGA,210 SDDR3 1GB D+V+HDMI with Low Profile bracket	Fanless heatsink, Nvidia CUDA technology, Nvidia PureVideo HD technology, Nvidia PhysX-Ready, HDCP	\$0.00	75	\$0.00
7	310034	Generic, 120GB SSD SOLID STATE HARD DRIVE, 2.5"		\$0.00	75	\$0.00
8	282552	GENERIC 2.5" to 3.5" MOUNTING BRACKET WITH SCREW FOR SSD		\$0.00	75	\$0.00
9	73713	UPGRADE CHARGE (PER UNIT)		\$0.00	75	\$0.00
10		DELL, OPTIPLEX 7010, SFF, I5 3470, 3.2 GHZ, 8.0 GB, 120GB SSD, DVD	Same specifications with 8gb ram and 120gb ssd	\$283.00	75	\$21,225.00
11		DELL, OPTIPLEX 7010, SFF, I5 3470, 3.2 GHZ, DDR3, 4.0 GB, 240 GB SSD, DVD/RW, GB NIC	Same specifications with 4gb ram and 240gb ssd	\$276.00	75	\$20,700.00
12		DELL, OPTIPLEX 7010, SFF, I5 3470, 3.2 GHZ, DDR3, 8.0 GB, 240 GB SSD, DVD/RW, GB NIC	Same specifications with 8gb ram and 240gb ssd	\$294.00	75	\$22,050.00
13	305634	DELL,P2014HT, VGA & DVI & DISPLAYPORT, 20W LCD, Black, REGULAR STAND		\$71.00	75	\$5,325.00
		5 YEAR LCD Warranty				
14	165320	DELL,P2211HT, VGA & DVI, 22W LCD, Black, REGULAR STAND		\$89.00	75	\$6,675.00
		5 YEAR LCD Warranty				

Terms	Notes
NET 30 DAYS	PRICE GOOD THROUGH JUNE 13,2020, SHIPPING INCLUDED.

Sub-total:	\$95,850.00
Shipping:	\$0.00
Tax:	\$0.00
Total:	\$95,850.00

Shipping Method: SELECT CARRIER: **Currency:** US

Leasing for 3-yrs, paid annually, in advance	\$34,437.95
Leasing for 4-yrs, paid annually, in advance	\$26,795.83
Final approval and rental pricing is dependent on a credit review conducted by a CDI preferred leasing partner. Lease structure includes a \$1 purchase option at term of lease.	



Hickman County Schools
Refurbished Desktop Computers & Monitors
Vendor Bid by:
Coretek Enterprises, LLC

A) PC - Model: Dell GX790/(9010) Small Form Factor (SFF)

- Processor - Intel Core i5 2400 3.10 GHz / (3579 3.40 GHz)
- Memory - 4GB RAM
- Hard Drive - 128GB SSD
- Operating System - Windows 10 Pro 64-bit
- Includes Keyboard and Power Cord
- Plus all other specs as listed in Hickman County Schools "Part B Specifications"
- Warranty - 5 year (see enclosed warranty document for details)
- Free Shipping

Price per unit = \$189.00

Total (75 units x \$189.00) = \$14,175.00

B) Monitor - Model: Dell U2311HB

- Screen Size – 23" Widescreen LCD
- Resolution - High Definition / 1920 X 1080
- VGI / DVI Display Port Connections
- Warranty - 5 year (see enclosed warranty document for details)
- Free Shipping

Price per unit = \$80.00

Total (75 units x \$80.00) = \$6,000.00

Combined Totals (Desktop Computer & Monitor Combination)

Price per Single Combo (1 PC & 1 Monitor) = \$269.00

Total (75 units x \$269.00) = \$20,175.00



Coretek Warranty Policy Hickman County Schools

Under this bid Coretek Enterprises will provide Hickman County Schools a five (5) year warranty on all Windows based PC Products purchased directly from Coretek. Coretek warrants that the product within this bid will be free from defects under normal use and service for a period of five (5) years, commencing with the original ship date of the product.

Coretek may, at its discretions, repair or replace any computer or equipment found to be defective under the terms of this warranty. This warranty will provide accidental damage protection within its terms excluding the items/situation as follows:

This warranty does not cover: Batteries, Software, Viruses, Key Codes, or Data stored on the computer. It also does not cover damage that arises from liquid spills, drops or electrical damage from power spikes or improper connections and/or physical abuse to the unit.

Coretek will pay for shipping both ways for products covered by this warranty. Customer is responsible for obtaining an RMA (Return Merchandise Authorization) from Coretek Customer Service prior to returning the product.

Account Contact: Michael R. Nelson
Direct Office: 980-781-5849 (M-F 8:30am to 6:00pm EST)
Cell Phone: 704-763-3012 (off business hours access)
Email: mike@coretek.us

Customer Service Contact: Kevin Sullivan
Office: 704-792-2221 (M-F 9:00am to 5:00pm EST)
Email: kevin@coretek.us



Coretek Enterprises, LLC

References for Hickman County Schools

1. Axtell Independent School District

308 Ottawa Street

Axtell, TX 76624

Contact: Ms. Janice Hornsby - Technology Coordinator

Phone: 254- 863-5301

Email: jhornsby@axtellisd.net

1. Finneytown Local School District

8916 Fontaineblue Terrace

Cincinnati, Ohio, 45231

Contact: Mr. Al Bolton - Dir of Information Tech

Phone: 513-476-9821

Email: abolton@finneytown.org

2. Terrell County Schools

761 1st Ave. SE

Dawson, GA 39842

Contact: Mr. Steve Phillips - Technology Director

Phone Direct: 229-995-4796

Cell: 229-364-4022

Email: sphillips@terrell.k12.ga.us

3. Prentice School District

1025 Town Street

Prentice, WI 54556

Contact: Mr. David Heikkinene - Network Administrator

Phone: 715-428-2811

Email: helpdesk@prentice.k12.wi.us

COPY

Invitation to
Bid

The Hickman County Finance Office is accepting sealed bids for Chromebook Units, Chrome OS Management Service License and Chromebook Carts.

Bid with specifications are online at: www.hickmank12.org/request-for-proposal.

Sealed bids must be mailed or delivered to the Hickman County Finance Office, 114 North Central Avenue, Suite 203, Centerville, TN 37033 and clearly marked on the outside of the envelope "Chromebooks, Licensees and Carts". Bids will be opened on Tuesday, February 19th, 2019 at 10:00 a.m. in the Finance Office. The Hickman County Board of Education reserves the right to accept or reject any and all bids or parts of bids and to waive any informalities that would prevent the acceptance of a better bid.

Present Penny Mayberry
Candi Davis

BGC
HP Chromebook 279.00 unit cost 1465
Chromebook H Charging Cart 999.00 32 slot
1165.00 40 slot

Firefly Computers
Grand Total for All 1081.00

252.00 UNIT
824.00 36 SLOT CART



**Hickman County Schools
Charging Cart Bid**

Chromebook 14 Charging Cart

Specifications

Type: Custom Education Furniture

Model: EZU-40

Slot Number: 40 slots

Features

- ✦ Cord keeper on front edge for easy cable management
- ✦ Keyed locking door and cord wraps
- ✦ Front pullout shelves for access to surge protector outlets
- ✦ Heavy Duty 5" locking casters

Warranty

- ✦ 10 year parts warranty (not including surface damage)
- ✦ Limited Lifetime Warranty of Surge Protectors

Unit Price: \$1,165.00

(unit pricing includes all delivery and shipping costs)



Greetings!

BGCSystems is an IT company specializing in the sales and service of commercial businesses and educational institutions in the Tennessee, Kentucky, and Southeast Missouri areas.

Currently, we hold bids with several Tennessee and Southeast Missouri school districts and are equipped to complete and fulfill any hardware needs that your organization is facing or may face in the future.

In this packet, we have included a list of our references as well as all the contact information you need to reach me and my team.

Please let me know if you have any questions for me. We greatly appreciate the opportunity to work with you and hope we will have that chance in the future!

Sincerely,

A handwritten signature in black ink, appearing to read 'Matthew Barnes', with a long horizontal stroke extending to the right.

Matthew Barnes
President

www.BGCSYSTEMS.COM | Fax: 877.472.0270

174 Saundersville Rd Suite 501 Hendersonville, TN 37075 | P: 615.761.9040



**Services Included in
Unit Pricing/Notes to Bid**

**ATTENTION:
Hickman County Finance Office
114 North Central Avenue
Suite 203
Centerville, TN 37033**

**FROM:
Bluegrass Computer Systems, LLC
174 Saundersville Road, Suite 501
Hendersonville, TN 37075**

SUBJECT: Chromebooks, Licenses and Carts Bid

Non-Technical Acknowledgements/ Notes

- 1) All Equipment is Brand New, Non- Refurbished
- 2) BGCSystems acknowledges that net 30 terms is to be extended for all purchases.
- 3) BGCSystems acknowledges that the school district is exempt of all sales taxes.
- 4) BGCSystems promises to provide delivery of all goods within 15 days of Purchase Order date. This statement is provided that all products are in manufacture "stock". Certain items may require longer periods of time for delivery. Estimates are available before purchase if requested.
- 5) All Orders will be delivered to the school location of choice FOB.

6) All pricing is guaranteed from February 19th, 2019 through May 31st, 2019.

7) BGCSystems has been in operation since 2010 and operates in multiple states and was awarded Ingram Micro's SMB Award as being the 12th fastest growing IT company in the nation for periods of 2012-2015. Proof of Financial and Business Capability is available per request.

8) BGCSystems will NOT subcontract in any way.

9) BGCSystems allows full Cooperative Purchasing with all government and education entities within the state of TN.

10) BGCSystems carries \$4,000,000 of General Liability Insurance, \$500,000 of Professional Liability Insurance and will name the school district as an additional insured if requested. BGCSystems carries full worker's compensation insurance on all employees and can provide proof if request.

11) BGCSystems is providing a toll free number, (877) 909-0515

12) BGCSystems maintains their corporate sales and service office in Hendersonville, TN.

13) BGCSystems has provided very competitive pricing that is based on reasonable quantity order as recorded by sales history to other districts that compare to the student population of the school district. However, additional discounts may be offered for additional quantities.

14) Length of Years in Business: 8 total years with direct focus of K-12 Education in the Missouri and Tennessee markets.

15) BGCSystems holds and maintains a business license in Hickman County, Tennessee.

- 16) Warranty/Service Experience: School District. may request warranty service through our help desk at (877) 909-0515, by emailing max@bgcsystems.com or by submitting a warranty ticket at the BGCSystems Online Client Portal. BGCSystems will work directly with the manufacture to provide warranty assistance. School District will NOT have to call manufacture directly for any type of support, however, a toll free support line to each manufacture will be made available to the district if the district wishes.
- 17) Vendor Help Desk: BGCSystems Help Desk is available from 8am to 5pm Monday- Friday at (877) 909-0515. Additional time may be requested at no additional charge for after hour or weekend support. The BGCSystems Online Client Portal will be available to the district 24 hours a day, 7 days a week. The Client Portal will allow for warranty tickets to be created, help desk (general questions) tickets to be created and provide a custom knowledgebase of articles pertaining to products owned by the school district.
- 18) BGCSystems has provided detailed explanation of compliance of bid specification on this document, however in addition, BGCSystems provides a blanket compliance of all bid specifications as outlined in the bid packet.
- 19) BGCSystems agrees to purchase and secure and bid, performance, and/or payment bonds as requested by school district.
- 20) Please consider our services, listed below, that are included free of charge in each of our bid prices.



Services Included in Unit Pricing/Notes to Bid

Technical Acknowledgements/ Notes

Chromebooks- BGCSYSTEMS will providing the following services for Chromebook purchases

- a. "White Glove" service to include enrollment, asset tag placement, and Chromebook Management Sub Organization creation
- b. Warranty Support to allow the district to request service from BGCSYSTEMS directly for all warranty needs.
- c. Onsite Delivery, Installation, and trash removal provided by BGCSYSTEMS staff member.

Computer Systems (Desktops and Laptops) BGCSYSTEMS will providing the following services for Computer Systems purchases

- d. "White Glove" service to include domain join, asset tag placement, and full system imaging. System imaging to include imaging per direct specification of technology coordinator.
- e. Warranty Support to allow the district to request service from BGCSYSTEMS directly for all warranty needs.
- f. Onsite Delivery, Installation, and trash removal provided by BGCSYSTEMS staff member.



Education Client References

This is a list of several customers of Bluegrass Computer Systems, LLC. Please feel free to use these individuals should you seek personal and professional references on our behalf.

- Stewart County Schools
Dover, TN
Chris Guynn – (931) 232-5176
- Delta R-V Schools
Delta, MO
Scott Crabtree – (573) 794-2511
- Henry County Schools
Paris, TN
Denton Jordan – (731) 644-2521
- Charleston R-1 School District
Charleston, MO
Nate Burton - (573) 683-3776
- Humboldt City Schools
Humboldt, TN
Wayne Sheehan- (731) 414-8625



1271 Red Fox Road, Saint Paul, MN 55112

February 11, 2019

Hickman County Finance Office
114 North Central Avenue, Suite 203
Centerville, TN 37033

Chromebooks, Licenses, and Carts

To Whom It May Concern,

Introduction

Please accept our enclosed proposal for your *Chromebooks and Carts* bid request. FireFly Computers is a top national provider of innovative classroom computing solutions for education. Since 2011, we've reimagined what a technology vendor can do to help school administrators meet their technology goals. FireFly focuses on providing knowledgeable, end-to-end customer support and innovative service options to save schools time, effort, and money. Unlike vendors who just focus on the initial sale, our products and services support you throughout the entire device lifecycle, from finding the right equipment, to deployment, teacher professional development, warranty support, parts and repairs, and even used device buy-back credit.

FireFly's unique, customer-focused approach has earned us several awards, including three years in a row on the Inc. 5000 list of the fastest-growing companies in America, the Deloitte 'Fast 500' list, and Inc. Magazine's 'Best Workplaces' list 2018. We currently do business with over 2,000 school districts and organizations across all 50 US states. FireFly is an Intel Gold Technology Provider, Google for Education Partner, and one of the top 10 vendors of Google Chrome products worldwide. We are also an HP Gold Partner and HP Authorized Services Provider.

At FireFly Computers, we pride ourselves on providing the very best customer service in the educational technology industry. You will have direct access to your own dedicated, US-based, FireFly Account Manager who can help with everything from pre-sales questions to warranty support. This means you'll always get reliable service from someone who knows your account and can provide you with the timely assistance you deserve.

Proposal Overview

We are proposing the HP Chromebook 14 G5 with Chrome Management License, White Glove Service, and Asset Tagging; that meet or exceed the bid specifications. We are also proposing the Aver E36c Charging Cart with Wiring Service. Pricing is valid through May 31st, 2019 as requested in the proposal. All products are brand new, and free FOB Destination shipping is included.



FREE Technical Assistance from FireFly Computers Engineers

At FireFly Computers, we have unparalleled experts in deploying 1-to-1 Chromebooks in education. If awarded, our support team will be available to you by phone or email at no additional charge to answer unlimited questions about how to configure the Chrome Management Console or tackle any troublesome issues that arise.

Warranty

FireFly Computers is an HP Authorized Services Provider, which allows us to be a one-stop shop for any warranty or repair services needed throughout the life of the devices. We make submitting warranty claims easy, just contact FireFly Computers by toll-free phone (866-950-8868), email (rma@fireflycomputers.com), or web (<http://fireflycomputers.com/rma/>).

FireFly Computers further simplifies and streamlines the warranty process through our free FireFly *Smart* RMA™ program. Several FireFly *Smart* RMA™ boxes will arrive with the initial Chromebook order. When a device needs repair, it can be inserted into the secure packaging provided, and when the school has five or more devices ready to go, they simply contact us for a pre-paid UPS shipping label. Additional *Smart* RMA™ boxes will be replenished as needed throughout the length of the warranty term. This program is for your convenience and does not interfere with your rights to send individual devices for repair under the standard warranty terms.

Customizable White Glove Setup with Asset Tagging

FireFly Computers specializes in products and services for the complete Chromebook lifecycle. Our Google® Certified support team has setup and configured Chrome Management settings for very large deployments of 10,000+ Chromebooks all the way down to small deployments of a few dozen devices. We're happy to work with you to pre-configure your Chromebooks exactly the way you want them and deliver the devices exactly matching your preferences and specifications. We can pre-assign Chromebooks to specific OUs (organizational units), apply customized desktop backgrounds and screen savers, or even ship orders in separate groups according to OU. No other vendor provides the same level of customization options and expertise as FireFly Computers.

Our typical "White Glove" setup includes:

- Pre-enrolling devices in the District's G Suite (Google Apps) Domain
- Preconfiguring Wi-Fi settings for all devices
- Updating Chrome OS to the latest stable public release
- Applying District-specific settings and customizations to each device, if desired
- Assigning subsets of devices to specific Organizational Units (OUs), if desired
- Basic testing to replace defective and DOA units prior to shipping



Off-Warranty Parts and Repairs

Many of our customers have expressed interest in self-repairing Chromebooks that are no longer under warranty. FireFly Computers has launched a new "Repair Zone" website where individual Chromebook repair parts are available for purchase at <http://fireflyrepairzone.com>. If professional repair is desired, parts purchased on the Repair Zone can also be installed by FireFly Technicians at competitive fixed-rates. FireFly can also perform standard "break-fix" assessments and provide the district with quotes specifying the estimated costs for individual repairs.

FireFly Computers has launched a student repair program featuring our "Do-It-Yourself Chromebook Repair Kit." The kit includes tools, parts, and supplies for two or more students to perform over 50+ common Chromebook repairs. Along with the repair kit, districts receive access to FireFly's online video library of step-by-step Chromebook repair videos and the ability to consult with FireFly Solutions Engineers by phone or email for on-demand assistance when needed. It's a great way for students to gain valuable life skills, and at the same time extend the life of district technology.

In summary, we hope our proposal provides your district with the very best solution for your upcoming technology purchases. Please let us know if we can provide additional information or answer any questions. FireFly Computers is proud to be a 100% woman-owned small business. Thank you.

Sincerely,

A handwritten signature in black ink, appearing to read 'Kari Phillips', is written over a light blue circular stamp.

Kari Phillips
CEO, FireFly Computers LLC

Primary Sales Contact:

Philip Crawford

651-400-1043 (direct)

1-866-950-8868 x 121 (toll-free)

612-392-2155 (fax)

philip@fireflycomputers.com



1271 Red Fox Road
 Saint Paul, MN 55112
 www.fireflycomputers.com

Quotation

Quote# 654995
 Valid Until: 03/13/2019

Terms

Net 30 Days

Customer

Hickman County School District
Brad Gilbert
 Phone: 931-729-3391 x2229
 Email: brad.gilbert@hickmank12.org

Account Manager

Philip Crawford
 Phone: 866-950-8868 x 121
 Fax: 612-392-2155
 Email: philip@fireflycomputers.com

Product Details	Quantity	Unit Price	Extended Price
HP Chromebook 14 G5 14 G5 14" LCD Chromebook Intel Celeron N3350 Dual-core (2 Core) 1.10 GHz 4 GB LPDDR4 16 GB Flash Memory Chrome OS 1366 x 768 Twisted nematic (TN)	1	\$219.00	\$219.00
Chrome Management Console	1	\$25.00	\$25.00
White Glove Service Preconfigured wireless access settings Pre-enrolled in Google Apps® domain Chrome OS® updates installed Custom themes and settings applied Hardware functionality check Google Console OU management	1	\$6.00	\$6.00
Asset Tagging With White Glove Asset Tagging Fee When Completed With FireFly's White Glove Service	1	\$2.00	\$2.00
FireFly Chromebook Support for HP • Easy-to-use Online RMA Portal for Simplified Warranty Claim Submissions • FireFly SMART RMA Boxes for Convenient Bulk Warranty Returns and Bulk Paid Repairs • Unlimited Chromebook Technical Support by Phone or Email from Google-Certified Engineers • Access to FireFly Repair Zone Website for Easy Ordering of Chromebook Parts and Repairs • Complimentary Assistance Claiming Free Offers, when available	1	\$0.00	\$0.00
AVer E36c Charging Cart Clear-cut power and cable management Most economical AVer Cart offering Compact Design Stores up to 36 devices 3-point steel locking mechanism *Best-in-class Customer Support & Warranty* 10-year warranty on mechanics and 5-year on electronics	1	\$829.00	\$829.00
Charging Cart Wiring Service	1	\$0.00	\$0.00
		Sub Total	\$1,081.00
		Tax	\$0.00
		Shipping	\$0.00
		Grand Total	\$1,081.00

Please fax purchase orders to 612-392-2155 or email to orders@fireflycomputers.com

Special Offers / Notes

- Freight Included
- Price valid for multiple units

Browse and Shop Our Online Store
 www.fireflyadvantage.com

Prices reflect 3% discount for cash/check payment. Credit card payment is accepted without discount.

Notice: This quote is confidential and is to be viewed solely by individuals within the organization to whom it is addressed. Unauthorized distribution or disclosure of the contents of this quote is strictly prohibited. If you are not from the organization addressed, please notify us immediately so we can prepare a quote specific to your organization. Prices and availability may change without notice prior to the quote expiration date.

HP Chromebook 14 G5



Master productivity with the sleek, durable HP Chromebook 14 G5, built with the manageable, secure, and intuitive Chrome OS™ and driven by the latest Intel® Celeron® processors. It's future-ready for evolving workspaces with universal USB-C™ compatibility and an optional FHD IPS touchscreen.²



Speed through your day

Quickly launch apps and browse the web, efficiently manage battery life, and get up to a 26% performance improvement³ with Intel® Celeron® processors¹, memory to 8 GB, and eMMC storage to 64 GB.⁴

Lighten your load

Meet everyday challenges head on and retain focus with a quiet, lightweight Chromebook™ that has a pick- and minor spill-resistant keyboard and is designed to pass MIL-STD 810G⁵, even at <19mm thin. Stay connected with 2x2 802.11ac⁶ wireless.

Cleared to collaborate

Collaborate seamlessly with a design that lies flat and has a wide-angle HD webcam and echo-cancelling mic so the whole room can participate. Use the optional² backlit keyboard in low light and optional² FHD IPS touchscreen with Android™ apps.⁷

Universal connectivity and charging with USB-C™

Use the USB-C™ port to charge your Chromebook™ and accessories, connect to an optional² HP USB-C™ Dock for port and device connectivity or add an optional² USB-C™-compatible display for large-screen productivity.

- Breathe easy with the low-maintenance and highly manageable Chrome OS™, which updates itself automatically⁸ and has virus protection built in.
- Enjoy the freedom of going wherever your tasks take you with a long battery life that allows you to unplug and work at different sites throughout the day.
- Go with an HD or FHD IPS 14" diagonal non-touch for keyboard-heavy inputs, or select the HD or FHD touchscreen² for onscreen interactivity with touch-enabled Google Play™ apps.⁷
- Help prevent everyday wear and tear and water intrusion with a keyboard that resists picks and minor spills. Choose the optional backlit keyboard² for low-light work environments.
- Easily deploy, manage, and control users, devices and apps on all your HP Chromebooks with Google's optional Chrome Management Console.²
- Customize your Chromebook™ with the latest apps, tools, extensions and themes.⁷
- Get access to Google's G Suite of office productivity software that keeps you productive and connected to your e-mail, calendars, documents, spreadsheets, slides, and more in the cloud.⁷
- Rely on support you can trust with HP's world-class limited warranty.

HP Chromebook 14 G5 Specifications Table



Available Operating System	Chrome OS™
Processor Family	Intel® Celeron® processor
Available Processors	Intel® Celeron® N3450 with Intel® HD Graphics 500 (1.1 GHz base frequency, up to 2.2 GHz burst frequency, 2 MB cache, 4 cores) Intel® Celeron® N3350 with Intel® HD Graphics 500 (1.1 GHz base frequency, up to 2.4 GHz burst frequency, 2 MB cache, 2 cores) 1
Maximum Memory	8 GB LPDDR4-2400 SDRAM
Internal Storage	16 GB up to 64 GB eMMC 5.0 2
Cloud Service	100 GB Google Drive™ (2-year subscription included) 3
Display	14" diagonal FHD IPS BrightView WLED-backlit touch screen, 220 cd/m², 72% sRGB (1920 x 1080) 14" diagonal HD SVA BrightView WLED-backlit touch screen, 220 cd/m², 72% sRGB (1366 x 768) 14" diagonal FHD IPS anti-glare WLED-backlit, 220 cd/m², 72% sRGB (1920 x 1080) 14" diagonal HD SVA anti-glare WLED-backlit, 220 cd/m², 72% sRGB (1366 x 768) 5a
Available Graphics	Integrated: Intel® HD Graphics 500 5
Wireless Technologies	Intel® Dual Band Wireless-AC 7265 802.11a/b/g/n/ac (2x2) Wi-Fi® and Bluetooth® 4.2 Combo, non-vPro™ 4,13 (Compatible with Miracast-certified devices.)
Expansion Slots	1 microSD (Supports SD, SDHC, SDXC.)
Ports and Connectors	2 USB 3.1 Type-C™; 2 USB 3.1 Gen 1 (HP Sleep and Charge); 1 headphone/microphone combo
Audio	HD audio, dual speakers, dual array microphone
Input Device	Full-size island-style, spill and pick resistant keyboard, optional backlit; Touchpad with multi-touch gesture support, taps enabled as default
Camera	720p HD camera 5
Available Software	HP Classroom Manager
Security Management	H1 Security IC; Nano Security lock slot 7
Power	45 W USB Type-C™ adapter 2-cell, 47.36 Wh Li-ion 9 Up to 10 hours 8 Battery life varies depending on configuration.
Dimensions	18.35 x 8.93 x 0.72 in 33.7 x 22.6 x 1.83 cm
Weight	Starting at 3.39 lb Starting at 1.54 kg (Weight will vary by configuration.)
Environmental	Low halogen 12
Energy Efficiency Compliance	ENERGY STAR® certified and EPEAT® Silver registered 11
Warranty	HP Services offers 1 year and 90 day limited warranty options depending on country. Batteries have a default 1 year limited warranty. On-site service and extended coverage is also available. HP Care Pack Services are optional extended service contracts that go beyond the standard limited warranties. Service levels and response times for HP Care Packs may vary depending on your geographic location. To choose the right level of service for your HP product, use the HP Care Pack Services Lookup Tool at: http://www.hp.com/go/cpc 10

AVerCharge E36c

36 Device Economy Charging Cart



Clear-cut power and cable management

Devices are easily cabled and fully charged free of any program setup or circuit overload! Simply connect E36c to an outlet and it will automatically circulate charges through each row of devices.

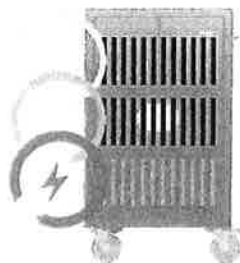

Easy on the pocketbook

Quality device management does not have to equate to big spending. E36c provides all your charging needs at a fraction of the cost.



One cart fits all

E36c easily supports 36 Laptops, Chromebooks, or Tablet devices with screens up to 15". Need to charge your own laptop while charging your students' tablets? Sure, why not.



Sleek and classy

Internally spacious enough to store 36 devices yet sleekishly designed externally to fit in the most confined spaces. Ideal for any tight areas!

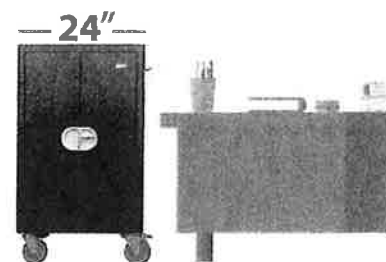

Maneuver with finesse

E36c's compact design and 5" swivel casters make it easier to transport devices and provide a smooth mobile experience even in the most crowded corridors or smallest spaces.



Specifications

Device Capacity	36	Slot Size	W = 3.2cm (1.26") D = 38cm (14.96") H = 26cm (10.24")
Support Device	Laptop/Chromebook/Tablets	Charging Type	Cycle Charging
Sync Type	N/A	External Power Outlets	N/A
LED Indicator	N/A	Sliding Shelves	N/A
Divider type	Metal Bar with Rubber Coating	Foam on Bar	No
Cart Dimension	H = 108.8cm (42.83") W = 68.8cm (27.09") D = 64cm (25.20")	Package Dimension	H = 125.5cm (49.41") W = 77cm (30.31") D = 73cm (28.74")
Net weight	60kg (132.3lbs)	Gross weight	79kg (174.2lbs)
Power Specification	AC IN: 100-120V ~ 50/60Hz, 12A PWR Strip 36-Port Total 100-120V ~ 50/60Hz, 11A	Cable Management	AC adaptor holder bin with built-in individual cable management metal clips
Security	Front doors: 3 point mechanism with lock hole	Casters	5" casters x 4 2 among are lockable
Security Hook	Yes	Fan	N/A
Warranty	10 years mechanical components 5 years electrical components	Adaptor holder inner dimension	N/A

AVer Information Inc. Americas
averusa.com
 668 Mission Court,
 Fremont, CA 94539
 T 408.263.3828
 F 408.263.8132
 toll free 1.877.528.7824

©Copyright 2016, AVer Information Inc. All rights reserved.
 Specifications subject to change without notice.

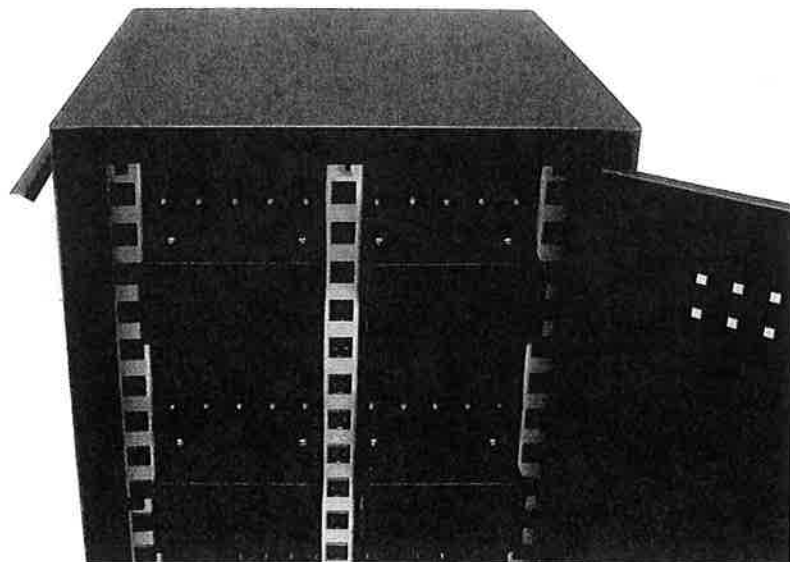

THE DEVICE LIFECYCLE EXPERTS™

CALL US TOLL-FREE
866-950-8868
sales@fireflycomputers.com

Pick a Device

Durability
Screen Size
Multitouch
Tablet Flip
Stylus

Choose Your Warranty

Accidental Damage
Battery Coverage
Manufacturer/Third Party

Device Buy-Back

Accepted Devices
Purchase Credit

Replacement Planning

Delivery Timing
Peak Availability

DIY Repair Kits / Parts

Training Videos
Tools and Workspaces
Online Parts Portal

Paid Repairs

Transparent Pricing
Simple to Use

RMA's / Warranty Repairs

Claim Assistance
Smart Boxes
Spares Closet

Select Your Services

Enrollment
Customization
Asset Tagging/Etching
Delivery Preferences

Storage and Charging

Carts or Cabinets
Intelligent Charging
Protective Cases

Management Software

Classroom Management
Content Filtering

Professional Development

MobileMind™ G Suite™ Cloud PD
Online Time-Conscious PD Micro-Courses

Financing Options

Length
FMV vs Buyout

DOA Assistance

Free Return Window



FireFly empowers your 1-to-1 technology plan!

Let us be your one-stop partner for the full life of your devices. From planning to setup to support, FireFly has you covered! Our expert team and innovative offerings have made us the top choice for technology professionals everywhere. Call us and see the difference for yourself!

YOU SAVE. WE SUPPORT.

Invitation To Bid

The Hickman County Finance Office is accepting sealed bids for "School Security Camera Systems".

Specifications can be found on-line at: www.hickmank12.org/request-for-proposal.

Sealed Bids must be mailed or hand delivered to the Hickman County Finance Office, 114 North Central Avenue, Suite 203, Centerville, TN 37033 and clearly marked on the outside of the envelope "School Security Camera Systems". Bids will be opened on March 18, 2019 at 10:00 a.m. in the Finance Office

The Hickman County Board of Education reserves the right to accept or reject any and all bids or parts of bids and waive any informalities that would prevent the acceptance of a better bid.

Present Renny Mayberry
Candi Davis

Central Technologies

BB-C

CES	13376.00	
ES	14049.75	185.00
IS	16780.25	185.00
IS	15172.25	185.00
CMS	16066.25	185.00
HMS	16042.25	185.00

Camera Type Price Licensing
See attached spreadsheet

Camera Type	Price	Licensing
Single HD Dome	299.00	79.00
Multi-Position HD	1049.00	79.00
HD PTZ	899.95	79.00
HD Bullet	599.00	79.00



Date: 03/18/19

Proposal put forth in response to: Hickman County Purchase of School Security Camera Systems

Dear Selection Committee,

Central Technologies is honored for the opportunity to work with Hickman County Schools on the latest video surveillance contract. Below is a detailed overview of our background and a few of our key advantages so you can get to know Central Technologies and familiarize yourself with our expertise primarily in the area of video surveillance.

Central Technologies is a Technology Solutions Provider based in Knoxville, Tennessee with a second office in Germantown, Tennessee and a warehouse in Jackson, Tennessee. Because we have a host of strategic partnerships that feature leading technology vendors and manufacturers, we are able to provide a strategic line of technology and security solutions, focused specifically on education, government, and corporate business. The Central Technologies sales and support staff has been supplying the Southeastern market with technology solutions for over 20 years.

At Central, we are more than just a technology solutions provider. We extend an expanded level of service for every solution we provide, focusing entirely on the needs of the customer. By providing this extended level of service, we aim to enhance the capabilities of every technological staff we work with. Our staff understands the importance of excellent customer service and embodies service at the heart of all their work.

Having been involved with the education industry for more than 20 years, our team understands that every budget is limited. However, we don't view a limited budget as an excuse to provide "budget" technological solutions. We are very proud to work within your parameters to ensure that you get the absolute best technology solutions possible, no matter the budget. We have worked with our customers time and again to secure state and federal funding sources to complete their project. Our #1 goal, in the end, is customer satisfaction 100% of the time with better service and smarter solutions.

Beyond offering extended service for our technological solutions, we want to contribute as much assistance as needed with long-term budget planning, fund searching, and any other project development needs you may have. Our Central Team is experienced, knowledgeable, and readily available to provide you with the best solutions, service, and guidance available.

We are eager to once again partner with Hickman County Schools with our exceptional expertise and service!

Sincerely,

A handwritten signature in black ink that reads "Joel Mayes". The signature is written in a cursive, flowing style.

Joel Mayes, Account Executive for Middle Tennessee

School Security Camera Systems - Hickman County Schools

Bid Form and Specifications/Scope of Work

The following Bid Form and Specifications/Scope of Work are to be used to submit bids by school.

Complete Pricing on this FORM and return with BID:

Camera Types: (cost should include any related licensing)
(All cameras must be network capable)

Camera Type	Price	Licensing
See attached spreadsheets		

Installation and all related materials

School	Installation Cost (including all related materials)	Other related Cost (please provide specifics on a separate sheet)
Centerville Elementary	13,376.00	NA
East Elementary	14,049.75	NA
Centerville Intermediate	16,780.25	NA
East Intermediate	15,172.25	NA
Hickman County Middle School	16,066.25	NA
East Hickman Middle School	16,042.25	NA

TOTAL

91,486.75

Centerville ES

CAMERAS

Code	Camera Type - description	Price	Quantity
3.0C-H4SL-BO1-IR	3.0MP, WDR, LightCatcher, Day/Night, Indoor/Outdoor Bullet, 3-9mm f/1.4, Integrated IR	\$ 370.50	4
3.0C-H4M-D1	3.0MP, WDR, LightCatcher, Day/Night, Indoor Dome, 2.8mm f/1.2	\$ 253.50	12
3.0C-H4SL-D1	3.0MP, WDR, LightCatcher, Day/Night, Indoor Dome, 3-9mm f/1.4	\$ 299.00	1
3.0C-H4SL-DO1-IR	3.0MP, WDR, LightCatcher, Day/Night Outdoor Dome, 3-9mm f/1.4, Integrated IR	\$ 370.50	1

SERVER & LICENSING

Server: installation, setup, initial training, labeling cameras and software, and licensing cost	\$ 1,781.00	
--	-------------	--

Central Technologies, Inc.
P.O. Box 30867
Knoxville, TN 37930
865-566-0230 Fax: 865-312-8190

3/17/2019
Quote #: 32877
Page: 1

Quoted To:
Hickman County Schools
115 Murphree Avenue
Centerville, TN 37033

Phone: 931-729-3391
Cust PO:
Reference: Centerville ES

Terms: Due On Receipt
Ship Via: Best Way

Salesperson: JRM
Valid Through: 6/15/2019

Stock Code	Description	Quantity	Price	Extended
SECAVIHD-NVR3-VAL-6TB-NA	Avigilon HD NVR3 VAL 6TB 1U Rack Mnt, Windows 10 IoT LTSB	1.00	2,925.00	2,925.00
LABORAVISERVER	Avigilon Server Installation- Includes Setup, Initial Training, and Labeling Cameras in Software	1.00	400.00	400.00
SECAVI3.0C-H4SL-BO1-IR	3.0 MP, WDR, LightCatcher, Day/Night, Indoor/Outdoor Bullet, 3-9mm f/1.4, Integrated IR	4.00	370.50	1,482.00
SECAVIH4-BO-JBOX1	Junction box for the H4A HD Bullet, H4SL HD Bullet, or H4 Thermal cameras	4.00	58.50	234.00
SECAVI3.0C-H4M-D1	3.0 MP, WDR, LightCatcher, Day/Night, Indoor Dome, 2.8mm f/1.2	12.00	253.50	3,042.00
SECAVIH4M-MT-DCIL1	In-Ceiling mount for H4M dome cameras	12.00	19.50	234.00
SECAVI3.0C-H4SL-D1	3.0 MP, WDR, LightCatcher, Day/Night, Indoor Dome, 3-9mm f/1.4	1.00	299.00	299.00
SECAVIH4SL-MT-DCIL1	Avigilon In-Ceiling mount for H4SL dome cameras H4SL-MT-DCIL1	1.00	19.50	19.50
SECAVI3.0C-H4SL-DO1-IR	Avigilon 3.0 MP, WDR, LightCatcher, Day/Night, Outdoor Dome, 3-9mm f/1.4, Integrated IR 3.0C-H4SL-DO1-IR	1.00	370.50	370.50
LABOROUTCAMERADATA	Outdoor Camera Installation with Data Drop	4.00	375.00	1,500.00
LABORINDCAMERADATA	Indoor Camera Installation with Data Drop	14.00	205.00	2,870.00

Centerville ES

SubTotal: 13,376.00
Tax: 0.00
Shipping: 0.00
Total: 13,376.00

TN Alarm Systems Contractor License Number- 2138 TN Contractor License Number - 67550
ALL PRODUCTS CARRY A MFR. DIRECT WARRANTY - RETURN OF NON-DEFECTIVE, UNOPENED ITEMS ACCEPTED 10 DAYS FROM SHIP DATE AND WILL REQUIRE PRODUCT MFR. APPROVAL PRIOR TO RETURN - A 15% RESTOCK FEE WILL APPLY - DAMAGED OR MISSING ITEMS MUST BE REPORTED WITHIN 48 HOURS - A FINANCE CHARGE OF 1.5% PER MONTH WILL BE APPLIED TO OVERDUE BALANCES - SPECIAL

East ES

CAMERAS

Code	Camera Type - description	Price	Quantity
3.0C-H4SL-BO1-IR	3.0MP, WDR, LightCatcher, Day/Night, Indoor/Outdoor Bullet, 3-9mm f/1.4, Integrated IR	\$ 370.50	6
3.0C-H4M-D1	3.0MP, WDR, LightCatcher, Day/Night, Indoor Dome, 2.8mm f/1.2	\$ 253.50	4
3.0C-H4SL-D1	3.0MP, WDR, LightCatcher, Day/Night, Indoor Dome, 3-9mm f/1.4	\$ 299.00	2
3.0C-H4SL-DO1-IR	3.0MP, WDR, LightCatcher, Day/Night Outdoor Dome, 3-9mm f/1.4, Integrated IR	\$ 370.50	1
12C-H4A-4MH-360	4 by 3MP 2.8mm Lens POE WDR LightCatcher Multisensor Camera Only 360 degree viewing	\$ 1,238.25	1

SERVER & LICENSING

	Server: installation, setup, initial training, labeling cameras and software, and licensing cost	\$ 1,781.00	
--	--	-------------	--

Central Technologies, Inc.
P.O. Box 30867
Knoxville, TN 37930
865-566-0230 Fax: 865-312-8190

3/17/2019
Quote #: 32882
Page: 1

Quoted To:
Hickman County Schools
115 Murphree Avenue
Centerville, TN 37033

Phone: 931-729-3391

Cust PO:

Reference: East ES

Terms: Due On Receipt

Ship Via: Best Way

Salesperson: JRM

Valid Through: 6/15/2019

Stock Code	Description	Quantity	Price	Extended
SECAVIHD-NVR3-VAL-12TB-NA	Avigilon HD NVR3 VAL 12TB 1U Rack Mnt, Windows 10 IoT LTSB	1.00	3,705.00	3,705.00
LABORAVISERVER	Avigilon Server Installation- Includes Setup, Initial Training, and Labeling Cameras in Software	1.00	400.00	400.00
SECAVI3.0C-H4SL-BO1-IR	3.0 MP, WDR, LightCatcher, Day/Night, Indoor/Outdoor Bullet, 3-9mm f/1.4, Integrated IR	6.00	370.50	2,223.00
SECAVIH4-BO-JBOX1	Junction box for the H4A HD Bullet, H4SL HD Bullet, or H4 Thermal cameras	6.00	58.50	351.00
SECAVI3.0C-H4M-D1	3.0 MP, WDR, LightCatcher, Day/Night, Indoor Dome, 2.8mm f/1.2	4.00	253.50	1,014.00
SECAVIH4M-MT-DCIL1	In-Ceiling mount for H4M dome cameras	4.00	19.50	78.00
SECAVI3.0C-H4SL-D1	3.0 MP, WDR, LightCatcher, Day/Night, Indoor Dome, 3-9mm f/1.4	2.00	299.00	598.00
SECAVIH4SL-MT-DCIL1	Avigilon In-Ceiling mount for H4SL dome cameras H4SL-MT-DCIL1	2.00	19.50	39.00
SECAVI3.0C-H4SL-DO1-IR	Avigilon 3.0 MP, WDR, LightCatcher, Day/Night, Outdoor Dome, 3-9mm f/1.4, Integrated IR 3.0C-H4SL-DO1-IR	1.00	370.50	370.50
LABOROUTCAMERADATA	Outdoor Camera Installation with Data Drop	6.00	375.00	2,250.00
LABORINDCAMERADATA	Indoor Camera Installation with Data Drop	8.00	205.00	1,640.00
SECAVI12C-H4A-4MH-360	Avigilon 4 by 3MP 2.8mm Lens POE WDR LightCatcher MultiSensor Camera Only 360 degree viewing	1.00	1,238.25	1,238.25
SECAVIH4AMH-AD-CEIL1	In-ceiling adapter, must order either a H4AMH-DC-COVR1 or H4AMH-DC-COVR1-SMOKE	1.00	97.50	97.50
SECAVIH4AMH-DC-COVR1	Dome bubble and cover, for in-ceiling mount, clear	1.00	45.50	45.50

East ES

7 existing IP cameras

Central Technologies, Inc.
P.O. Box 30867
Knoxville, TN 37930
865-566-0230 Fax: 865-312-8190

3/17/2019
Quote #: 32882
Page: 2

Quoted To:
Hickman County Schools
115 Murphree Avenue
Centerville, TN 37033

Phone: 931-729-3391

Cust PO:

Reference: East ES

Terms: Due On Receipt

Ship Via: Best Way

Salesperson: JRM

Valid Through: 6/15/2019

Stock Code	Description	Quantity	Price	Extended
------------	-------------	----------	-------	----------

SubTotal: 14,049.75

Tax: 0.00

Shipping: 0.00

Total: 14,049.75

TN Alarm Systems Contractor License Number- 2138 TN Contractor License Number - 67550

ALL PRODUCTS CARRY A MFR. DIRECT WARRANTY - RETURN OF NON-DEFECTIVE, UNOPENED ITEMS ACCEPTED 10 DAYS FROM SHIP DATE
AND WILL REQUIRE PRODUCT MFR. APPROVAL PRIOR TO RETURN - A 15% RESTOCK FEE WILL APPLY - DAMAGED OR MISSING ITEMS
MUST BE REPORTED WITHIN 48 HOURS - A FINANCE CHARGE OF 1.5% PER MONTH WILL BE APPLIED TO OVERDUE BALANCES - SPECIAL

Centerville IS

CAMERAS

Code	Camera Type - description	Price	Quantity
3.0C-H4SL-BO1-IR	3.0MP, WDR, LightCatcher, Day/Night, Indoor/Outdoor Bullet, 3-9mm f/1.4, Integrated IR	\$ 370.50	6
3.0C-H4M-D1	3.0MP, WDR, LightCatcher, Day/Night, Indoor Dome, 2.8mm f/1.2	\$ 253.50	3
3.0C-H4SL-D1	3.0MP, WDR, LightCatcher, Day/Night, Indoor Dome, 3-9mm f/1.4	\$ 299.00	3
3. C-H4SL-DO1-IR	3.0MP, WDR, LightCatcher, Day/Night Outdoor Dome, 3-9mm f/1.4, Integrated IR	\$ 370.50	1
9C-H4A-3MH-180	3 by 3MP 4mm Lens, 180, POE, WDR, LightCatcher, MultiSensor Camera Only 180 degree viewing	\$ 1,075.75	3

SERVER & LICENSING

Server: installation, setup, initial training, labeling cameras and software, and licensing cost	\$ 1,781.00	
--	-------------	--

Central Technologies, Inc.
P.O. Box 30867
Knoxville, TN 37930
865-566-0230 Fax: 865-312-8190

3/17/2019
Quote #: 32879
Page: 1

Quoted To:
Hickman County Schools
115 Murphree Avenue
Centerville, TN 37033

Phone: 931-729-3391
Cust PO:
Reference: Centerville IS

Terms: Due On Receipt
Ship Via: Best Way

Salesperson: JRM
Valid Through: 6/15/2019

Stock Code	Description	Quantity	Price	Extended
SECAVIHD-NVR3-VAL-12TB-NA	Avigilon HD NVR3 VAL 12TB 1U Rack Mnt, Windows 10 IoT LTSB	1.00	3,705.00	3,705.00
LABORAVISERVER	Avigilon Server Installation- Includes Setup, Initial Training, and Labeling Cameras in Software	1.00	400.00	400.00
SECAVI3.0C-H4SL-BO1-IR	3.0 MP, WDR, LightCatcher, Day/Night, Indoor/Outdoor Bullet, 3-9mm f/1.4, Integrated IR	6.00	370.50	2,223.00
SECAVIH4-BO-JBOX1	Junction box for the H4A HD Bullet, H4SL HD Bullet, or H4 Thermal cameras	6.00	58.50	351.00
SECAVI3.0C-H4M-D1	3.0 MP, WDR, LightCatcher, Day/Night, Indoor Dome, 2.8mm f/1.2	3.00	253.50	760.50
SECAVIH4M-MT-DCIL1	In-Ceiling mount for H4M dome cameras	3.00	19.50	58.50
SECAVI3.0C-H4SL-D1	3.0 MP, WDR, LightCatcher, Day/Night, Indoor Dome, 3-9mm f/1.4	3.00	299.00	897.00
SECAVIH4SL-MT-DCIL1	Avigilon In-Ceiling mount for H4SL dome cameras H4SL-MT-DCIL1	3.00	19.50	58.50
SECAVI3.0C-H4SL-DO1-IR	Avigilon 3.0 MP, WDR, LightCatcher, Day/Night, Outdoor Dome, 3-9mm f/1.4, Integrated IR 3.0C-H4SL-DO1-IR	1.00	370.50	370.50
LABOROUTCAMERADATA	Outdoor Camera Installation with Data Drop	6.00	375.00	2,250.00
LABORINDCAMERADATA	Indoor Camera Installation with Data Drop	10.00	205.00	2,050.00
SECAVI9C-H4A-3MH-180	Avigilon 3 by 3MP 4mm Lens, 180°, POE WDR LightCatcher MultiSensor Camera Only 180 degree viewing	3.00	1,075.75	3,227.25
SECAVIH4AMH-AD-CEIL1	In-ceiling adapter, must order either a H4AMH-DC-COVR1 or H4AMH-DC-COVR1-SMOKE	3.00	97.50	292.50
SECAVIH4AMH-DC-COVR1	Dome bubble and cover, for in-ceiling mount, clear	3.00	45.50	136.50

Centerville IS

SubTotal: 16,780.25
Tax: 0.00
Shipping: 0.00
Total: 16,780.25

TN Alarm Systems Contractor License Number- 2138 TN Contractor License Number - 67550
ALL PRODUCTS CARRY A MFR. DIRECT WARRANTY - RETURN OF NON-DEFECTIVE, UNOPENED ITEMS ACCEPTED 10 DAYS FROM SHIP DATE AND WILL REQUIRE PRODUCT MFR. APPROVAL PRIOR TO RETURN - A 15% RESTOCK FEE WILL APPLY - DAMAGED OR MISSING ITEMS MUST BE REPORTED WITHIN 48 HOURS - A FINANCE CHARGE OF 1.5% PER MONTH WILL BE APPLIED TO OVERDUE BALANCES - SPECIAL

East Hickman IS

CAMERAS

Code	Camera Type - description	Price	Quantity
3.0C-H4SL-BO1-IR	3.0MP, WDR, LightCatcher, Day/Night, Indoor/Outdoor Bullet, 3-9mm f/1.4, Integrated IR	\$ 370.50	4
3.0C-H4M-D1	3.0MP, WDR, LightCatcher, Day/Night, Indoor Dome, 2.8mm f/1.2	\$ 253.50	3
3.0C-H4SL-D1	3.0MP, WDR, LightCatcher, Day/Night, Indoor Dome, 3-9mm f/1.4	\$ 299.00	3
3.0C-H4SL-DO1-IR	3.0MP, WDR, LightCatcher, Day/Night Outdoor Dome, 3-9mm f/1.4, Integrated IR	\$ 370.50	1
9C-H4A-3MH-180	3 by 3MP 4mm Lens, 180, POE, WDR, LightCatcher, MultiSensor Camera Only 180 degree viewing	\$ 1,075.75	3

SERVER & LICENSING

Server: installation, setup, initial training, labeling cameras and software, and licensing cost	\$ 1,781.00	
--	-------------	--

Central Technologies, Inc.
P.O. Box 30867
Knoxville, TN 37930
865-566-0230 Fax: 865-312-8190

3/17/2019
Quote #: 32878
Page: 1

Quoted To:
Hickman County Schools
115 Murphree Avenue
Centerville, TN 37033

Phone: 931-729-3391

Cust PO:

Reference: East Hickman IS

Terms: Due On Receipt

Ship Via: Best Way

Salesperson: JRM

Valid Through: 6/15/2019

Stock Code	Description	Quantity	Price	Extended
SECAVIHD-NVR3-VAL-12TB-NA	Avigilon HD NVR3 VAL 12TB 1U Rack Mnt, Windows 10 IoT LTSB	1.00	3,705.00	3,705.00
LABORAVISERVER	Avigilon Server Installation- Includes Setup, Initial Training, and Labeling Cameras in Software	1.00	400.00	400.00
SECAVI3.0C-H4SL-BO1-IR	3.0 MP, WDR, LightCatcher, Day/Night, Indoor/Outdoor Bullet, 3-9mm f/1.4, Integrated IR	4.00	370.50	1,482.00
SECAVIH4-BO-JBOX1	Junction box for the H4A HD Bullet, H4SL HD Bullet, or H4 Thermal cameras	4.00	58.50	234.00
SECAVI3.0C-H4M-D1	3.0 MP, WDR, LightCatcher, Day/Night, Indoor Dome, 2.8mm f/1.2	3.00	253.50	760.50
SECAVIH4M-MT-DCIL1	In-Ceiling mount for H4M dome cameras	3.00	19.50	58.50
SECAVI3.0C-H4SL-D1	3.0 MP, WDR, LightCatcher, Day/Night, Indoor Dome, 3-9mm f/1.4	3.00	299.00	897.00
SECAVIH4SL-MT-DCIL1	Avigilon In-Ceiling mount for H4SL dome cameras H4SL-MT-DCIL1	3.00	19.50	58.50
SECAVI3.0C-H4SL-DO1-IR	Avigilon 3.0 MP, WDR, LightCatcher, Day/Night, Outdoor Dome, 3-9mm f/1.4, Integrated IR 3.0C-H4SL-DO1-IR	1.00	370.50	370.50
LABOROUTCAMERADATA	Outdoor Camera Installation with Data Drop	4.00	375.00	1,500.00
LABORINDCAMERADATA	Indoor Camera Installation with Data Drop	10.00	205.00	2,050.00
SECAVI9C-H4A-3MH-180	Avigilon 3 by 3MP 4mm Lens, 180°, POE WDR LightCatcher MultiSensor Camera Only 180 degree viewing	3.00	1,075.75	3,227.25
SECAVIH4AMH-AD-CEIL1	In-ceiling adapter, must order either a H4AMH-DC-COVR1 or H4AMH-DC-COVR1-SMOKE	3.00	97.50	292.50
SECAVIH4AMH-DC-COVR1	Dome bubble and cover, for in-ceiling mount, clear	3.00	45.50	136.50

East Hickman IS

SubTotal: 15,172.25
Tax: 0.00
Shipping: 0.00
Total: 15,172.25

TN Alarm Systems Contractor License Number- 2138 TN Contractor License Number - 67550
ALL PRODUCTS CARRY A MFR. DIRECT WARRANTY - RETURN OF NON-DEFECTIVE, UNOPENED ITEMS ACCEPTED 10 DAYS FROM SHIP DATE AND WILL REQUIRE PRODUCT MFR. APPROVAL PRIOR TO RETURN - A 15% RESTOCK FEE WILL APPLY - DAMAGED OR MISSING ITEMS MUST BE REPORTED WITHIN 48 HOURS - A FINANCE CHARGE OF 1.5% PER MONTH WILL BE APPLIED TO OVERDUE BALANCES - SPECIAL

Hickman County MS

CAMERAS

Code	Camera Type - description	Price	Quantity
3.0C-H4SL-BO1-IR	3.0MP, WDR, LightCatcher, Day/Night, Indoor/Outdoor Bullet, 3-9mm f/1.4, Integrated IR	\$ 370.50	6
3.0C-H4M-D1	3.0MP, WDR, LightCatcher, Day/Night, Indoor Dome, 2.8mm f/1.2	\$ 253.50	8
3.0C-H4SL-D1	3.0MP, WDR, LightCatcher, Day/Night, Indoor Dome, 3-9mm f/1.4	\$ 299.00	4
3.0C-H4SL-DO1-IR	3.0MP, WDR, LightCatcher, Day/Night Outdoor Dome, 3-9mm f/1.4, Integrated IR	\$ 370.50	1
9C-H4A-3MH-180	3 by 3MP 4mm Lens, 180, POE, WDR, LightCatcher, MultiSensor Camera Only 180 degree viewing	\$ 1,075.75	1

SERVER & LICENSING

Server: installation, setup, initial training, labeling cameras and software, and licensing cost	\$ 1,781.00	
--	-------------	--

Central Technologies, Inc.
P.O. Box 30867
Knoxville, TN 37930
865-566-0230 Fax: 865-312-8190

3/17/2019
Quote #: 32880
Page: 1

Quoted To:
Hickman County Schools
115 Murphree Avenue
Centerville, TN 37033

Phone: 931-729-3391
Cust PO:
Reference: Hickman MS

Terms: Due On Receipt
Ship Via: Best Way

Salesperson: JRM
Valid Through: 6/15/2019

Stock Code	Description	Quantity	Price	Extended
SECAVIHD-NVR3-VAL-6TB-NA	Avigilon HD NVR3 VAL 6TB 1U Rack Mnt, Windows 10 IoT LTSP	1.00	2,925.00	2,925.00
LABORAVISERVER	Avigilon Server Installation- Includes Setup, Initial Training, and Labeling Cameras in Software	1.00	400.00	400.00
SECAVI3.0C-H4SL-BO1-IR	3.0 MP, WDR, LightCatcher, Day/Night, Indoor/Outdoor Bullet, 3-9mm f/1.4, Integrated IR	6.00	370.50	2,223.00
SECAVIH4-BO-JBOX1	Junction box for the H4A HD Bullet, H4SL HD Bullet, or H4 Thermal cameras	6.00	58.50	351.00
SECAVI3.0C-H4M-D1	3.0 MP, WDR, LightCatcher, Day/Night, Indoor Dome, 2.8mm f/1.2	8.00	253.50	2,028.00
SECAVIH4M-MT-DCIL1	In-Ceiling mount for H4M dome cameras	8.00	19.50	156.00
SECAVI3.0C-H4SL-D1	3.0 MP, WDR, LightCatcher, Day/Night, Indoor Dome, 3-9mm f/1.4	4.00	299.00	1,196.00
SECAVIH4SL-MT-DCIL1	Avigilon In-Ceiling mount for H4SL dome cameras H4SL-MT-DCIL1	4.00	19.50	78.00
SECAVI3.0C-H4SL-DO1-IR	Avigilon 3.0 MP, WDR, LightCatcher, Day/Night, Outdoor Dome, 3-9mm f/1.4, Integrated IR 3.0C-H4SL-DO1-IR	1.00	370.50	370.50
LABOROUTCAMERADATA	Outdoor Camera Installation with Data Drop	6.00	375.00	2,250.00
LABORINDCAMERADATA	Indoor Camera Installation with Data Drop	14.00	205.00	2,870.00
SECAVI9C-H4A-3MH-180	Avigilon 3 by 3MP 4mm Lens, 180°, POE WDR LightCatcher MultiSensor Camera Only 180 degree viewing	1.00	1,075.75	1,075.75
SECAVIH4AMH-AD-CEIL1	In-ceiling adapter, must order either a H4AMH-DC-COVR1 or H4AMH-DC-COVR1-SMOKE	1.00	97.50	97.50
SECAVIH4AMH-DC-COVR1	Dome bubble and cover, for in-ceiling mount, clear	1.00	45.50	45.50

Hickman County MS

SubTotal: 16,066.25
Tax: 0.00
Shipping: 0.00
Total: 16,066.25

TN Alarm Systems Contractor License Number- 2138 TN Contractor License Number - 67550
ALL PRODUCTS CARRY A MFR. DIRECT WARRANTY - RETURN OF NON-DEFECTIVE, UNOPENED ITEMS ACCEPTED 10 DAYS FROM SHIP DATE AND WILL REQUIRE PRODUCT MFR. APPROVAL PRIOR TO RETURN - A 15% RESTOCK FEE WILL APPLY - DAMAGED OR MISSING ITEMS MUST BE REPORTED WITHIN 48 HOURS - A FINANCE CHARGE OF 1.5% PER MONTH WILL BE APPLIED TO OVERDUE BALANCES - SPECIAL

East Hickman MS

CAMERAS

Code	Camera Type - description	Price	Quantity
3.0C-H4SL-BO1-IR	3.0MP, WDR, LightCatcher, Day/Night, Indoor/Outdoor Bullet, 3-9mm f/1.4, Integrated IR	\$ 370.50	5
3.0C-H4M-D1	3.0MP, WDR, LightCatcher, Day/Night, Indoor Dome, 2.8mm f/1.2	\$ 253.50	8
3.0C-H4SL-D1	3.0MP, WDR, LightCatcher, Day/Night, Indoor Dome, 3-9mm f/1.4	\$ 299.00	4
3.0C-H4SL-DO1-IR	3.0MP, WDR, LightCatcher, Day/Night Outdoor Dome, 3-9mm f/1.4, Integrated IR	\$ 370.50	1
9C-H4A-3MH-180	3 by 3MP 4mm Lens, 180, POE, WDR, LightCatcher, MultiSensor Camera Only 180 degree viewing	\$ 1,075.75	1

SERVER & LICENSING

Server: installation, setup, initial training, labeling cameras and software, and licensing cost	\$ 1,781.00	
--	-------------	--

Central Technologies, Inc.
P.O. Box 30867
Knoxville, TN 37930
865-566-0230 Fax: 865-312-8190

3/17/2019
Quote #: 32881
Page: 1

Quoted To:
Hickman County Schools
115 Murphree Avenue
Centerville, TN 37033

Phone: 931-729-3391

Cust PO:

Reference: East Hickman MS

Terms: Due On Receipt

Ship Via: Best Way

Salesperson: JRM

Valid Through: 6/15/2019

Stock Code	Description	Quantity	Price	Extended
SECAVIHD-NVR3-VAL-12TB-NA	Avigilon HD NVR3 VAL 12TB 1U Rack Mnt, Windows 10 IoT LTSSB	1.00	3,705.00	3,705.00
LABORAVISERVER	Avigilon Server Installation- Includes Setup, Initial Training, and Labeling Cameras in Software	1.00	400.00	400.00
SECAVI3.0C-H4SL-BO1-IR	3.0 MP, WDR, LightCatcher, Day/Night, Indoor/Outdoor Bullet, 3-9mm f/1.4, Integrated IR	5.00	370.50	1,852.50
SECAVIH4-BO-JBOX1	Junction box for the H4A HD Bullet, H4SL HD Bullet, or H4 Thermal cameras	5.00	58.50	292.50
SECAVI3.0C-H4M-D1	3.0 MP, WDR, LightCatcher, Day/Night, Indoor Dome, 2.8mm f/1.2	8.00	253.50	2,028.00
SECAVIH4M-MT-DCIL1	In-Ceiling mount for H4M dome cameras	8.00	19.50	156.00
SECAVI3.0C-H4SL-D1	3.0 MP, WDR, LightCatcher, Day/Night, Indoor Dome, 3-9mm f/1.4	4.00	299.00	1,196.00
SECAVIH4SL-MT-DCIL1	Avigilon In-Ceiling mount for H4SL dome cameras H4SL-MT-DCIL1	4.00	19.50	78.00
SECAVI3.0C-H4SL-DO1-IR	Avigilon 3.0 MP, WDR, LightCatcher, Day/Night, Outdoor Dome, 3-9mm f/1.4, Integrated IR 3.0C-H4SL-DO1-IR	1.00	370.50	370.50
LABOROUTCAMERADATA	Outdoor Camera Installation with Data Drop	5.00	375.00	1,875.00
LABORINDCAMERADATA	Indoor Camera Installation with Data Drop	14.00	205.00	2,870.00
SECAVI9C-H4A-3MH-180	Avigilon 3 by 3MP 4mm Lens, 180°, POE WDR LightCatcher MultiSensor Camera Only 180 degree viewing	1.00	1,075.75	1,075.75
SECAVIH4AMH-AD-CEIL1	In-ceiling adapter, must order either a H4AMH-DC-COVR1 or H4AMH-DC-COVR1-SMOKE	1.00	97.50	97.50
SECAVIH4AMH-DC-COVR1	Dome bubble and cover, for in-ceiling mount, clear	1.00	45.50	45.50

East Hickman MS

SubTotal: 16,042.25

Tax: 0.00

Shipping: 0.00

Total: 16,042.25

TN Alarm Systems Contractor License Number- 2138 TN Contractor License Number - 67550

ALL PRODUCTS CARRY A MFR. DIRECT WARRANTY - RETURN OF NON-DEFECTIVE, UNOPENED ITEMS ACCEPTED 10 DAYS FROM SHIP DATE AND WILL REQUIRE PRODUCT MFR. APPROVAL PRIOR TO RETURN - A 15% RESTOCK FEE WILL APPLY - DAMAGED OR MISSING ITEMS MUST BE REPORTED WITHIN 48 HOURS - A FINANCE CHARGE OF 1.5% PER MONTH WILL BE APPLIED TO OVERDUE BALANCES - SPECIAL

Central Technologies, Inc.
P.O. Box 30867
Knoxville, TN 37930
865-566-0230 Fax: 865-312-8190

3/17/2019
Quote #: 32884
Page: 1

Quoted To:
Hickman County Schools
115 Murphree Avenue
Centerville, TN 37033

Phone: 931-729-3391

Cust PO:

Reference: Licenses-STD

Terms: Due On Receipt

Ship Via: Best Way

Salesperson: JRM

Valid Through: 6/15/2019

Stock Code	Description	Quantity	Price	Extended
SECAVI24C-ACC6-STD	ACC 6 Standard License for up to 24 Camera Channels 24C-ACC6-STD	4.00	2,373.00	9,492.00
SECAVI8C-ACC6-STD	ACC 6 Standard License for up to 8 Camera Channels 8C-ACC6-STD	1.00	795.00	795.00
SECAVI4C-ACC6-STD	ACC 6 Standard License for up to 4 Camera Channels 4C-ACC6-STD	1.00	399.00	399.00

SubTotal: 10,686.00

Tax: 0.00

Shipping: 0.00

Total: 10,686.00

TN Alarm Systems Contractor License Number- 2138 TN Contractor License Number - 67550
ALL PRODUCTS CARRY A MFR. DIRECT WARRANTY - RETURN OF NON-DEFECTIVE, UNOPENED ITEMS ACCEPTED 10 DAYS FROM SHIP DATE
AND WILL REQUIRE PRODUCT MFR. APPROVAL PRIOR TO RETURN - A 15% RESTOCK FEE WILL APPLY - DAMAGED OR MISSING ITEMS
MUST BE REPORTED WITHIN 48 HOURS - A FINANCE CHARGE OF 1.5% PER MONTH WILL BE APPLIED TO OVERDUE BALANCES - SPECIAL



CENTRAL
Technologies, Inc.



Avigilon Scope of Work Hickman County Schools

Central Technologies proposes to provide the following services:

- Provide and mount cameras per approved design
- Plug cameras in to LAN
- Aim cameras with customer to validate preferred coverage area
- Install Avigilon server/appliance in location provided by customer
- Update server to preferred software version and install licenses
- Incorporate cameras in to the ACC software and set up using the proposed design settings
- Install ACC software on PCs that will be accessing the system
- Provide one day of onsite training for users (Additional training may be provided remotely per customer's request)
- Seal all outdoor camera locations
- Customer to provide PoE switch ports
- All cabling for cameras will be CAT6, drops will include necessary patch cables and panels - drops will be pulled to the nearest IDF closet
- Customer to provide all power, racks, and UPS if required

Warranty

All cameras, appliances and servers include a three-year warranty provided by Avigilon support 888-281-5182. Central Technologies does offer onsite support and service.

Central Technologies will offer **22% discount** on the entire Avigilon catalog for any related Avigilon items not included in this bid

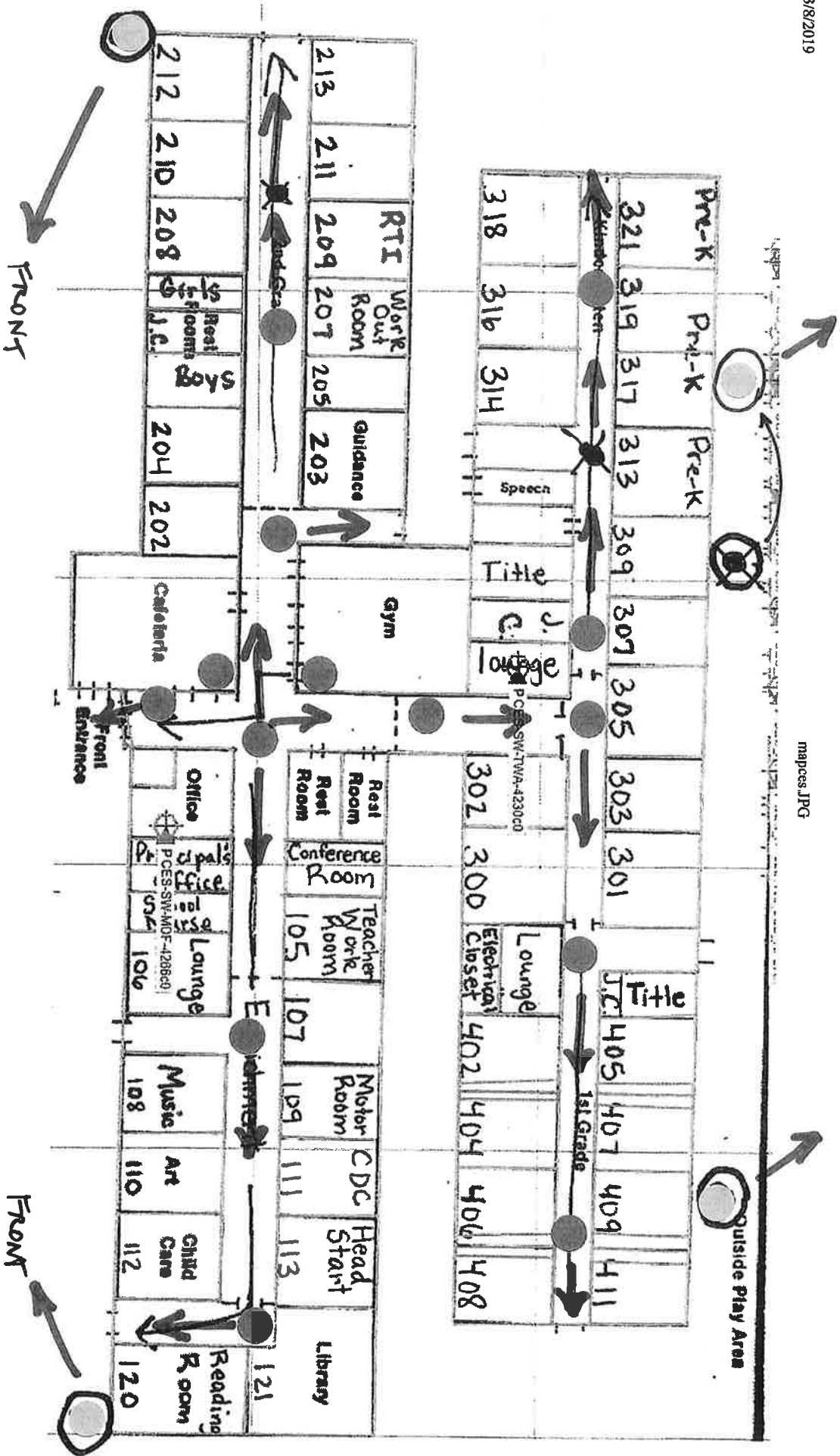

Centerville Elementary

- INTERIOR (14)
- EXTERIOR (4)

TOTAL 18

3/8/2019

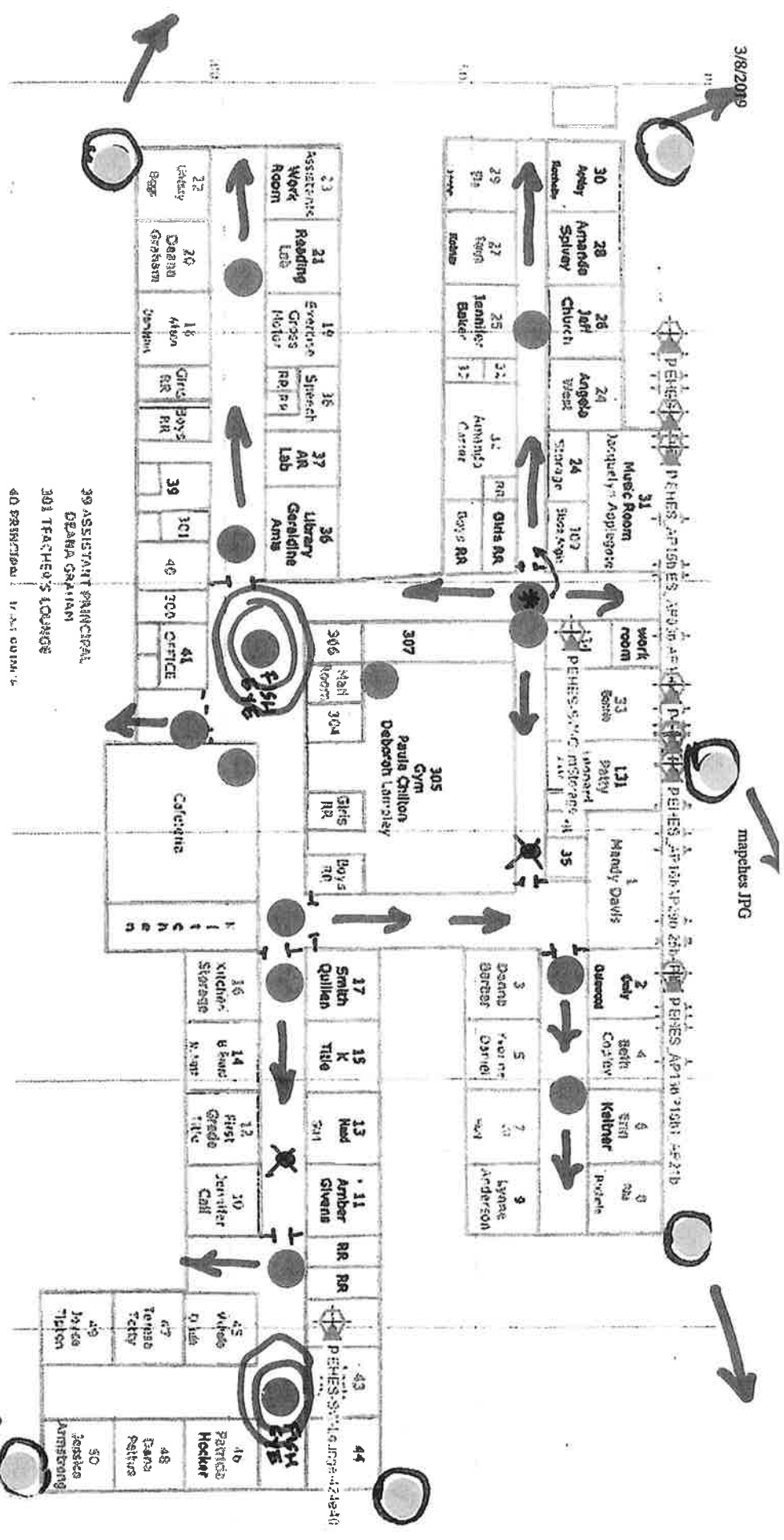

EXIST ES

* MOVE EXISTING CAMERA AND REPLACE W/3WAY

- EXISTING CAMERAS
- INTERIOR (8)
- EXTERIOR (6)

TOTAL ▶ 14

White Oak Trail

mapois.JPG

POIS: AP100 to POIS: AP210

Centerville Intermediate

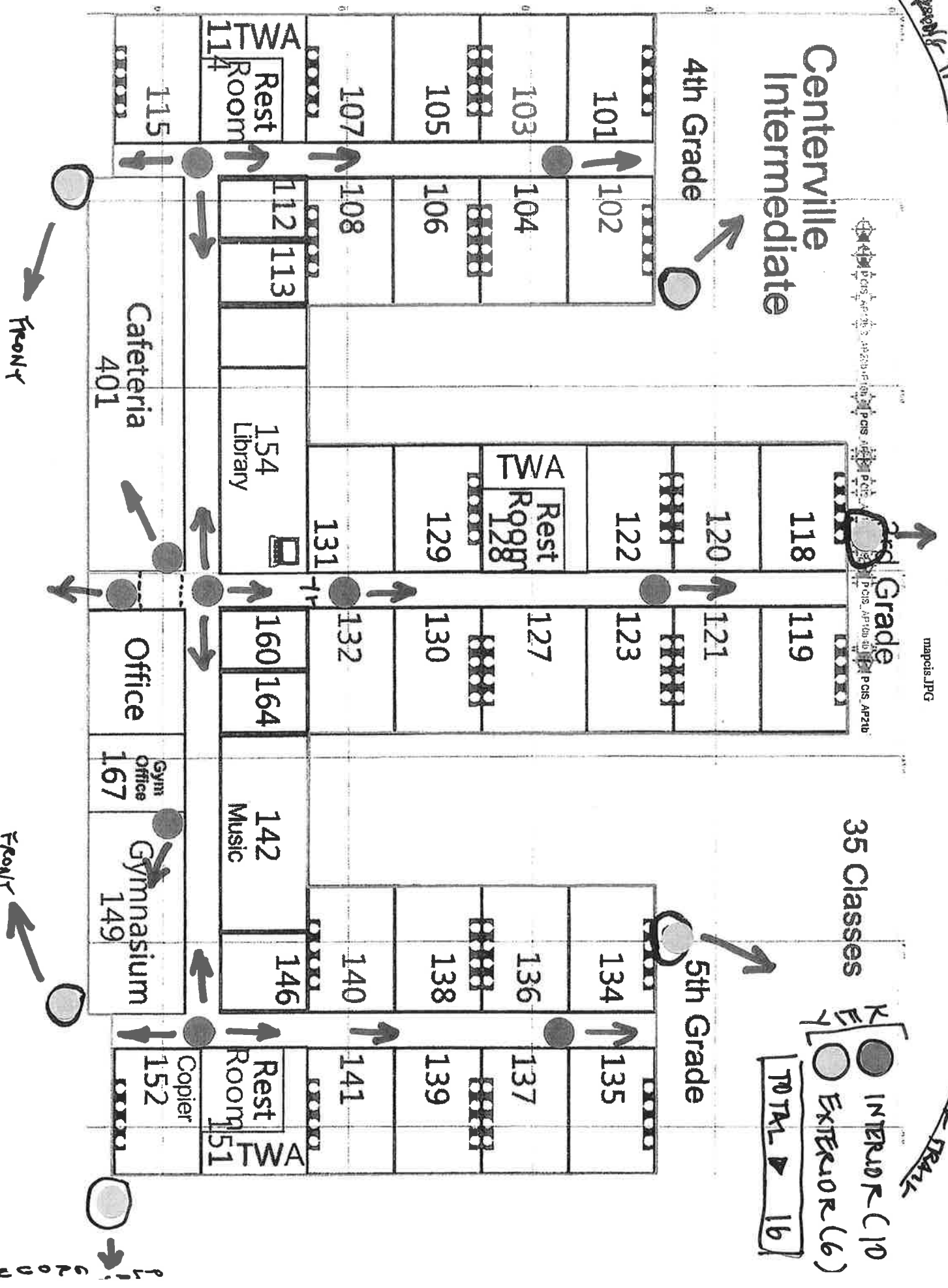

KEY

- INTERIOR (10)
- EXTERIOR (6)

TOTAL 16

White Oak Trail

East Hickman Intermediate

4th Grade

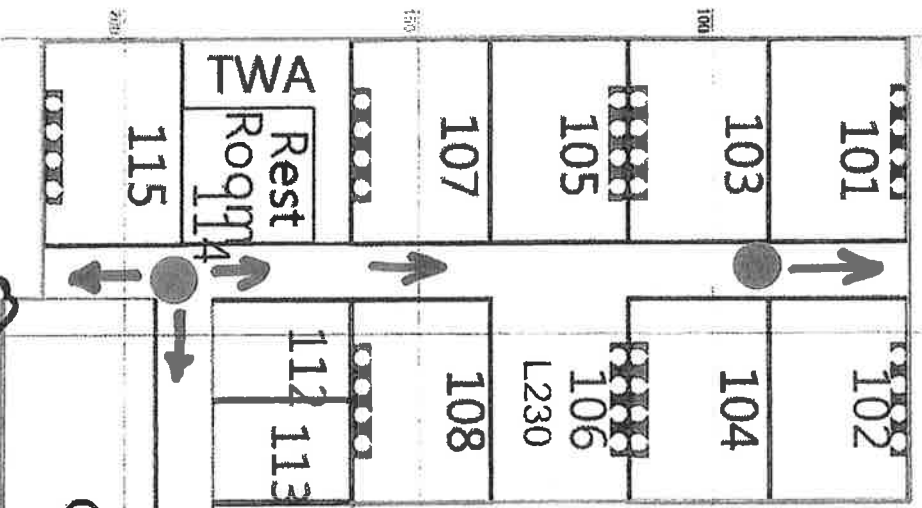

3rd Grade

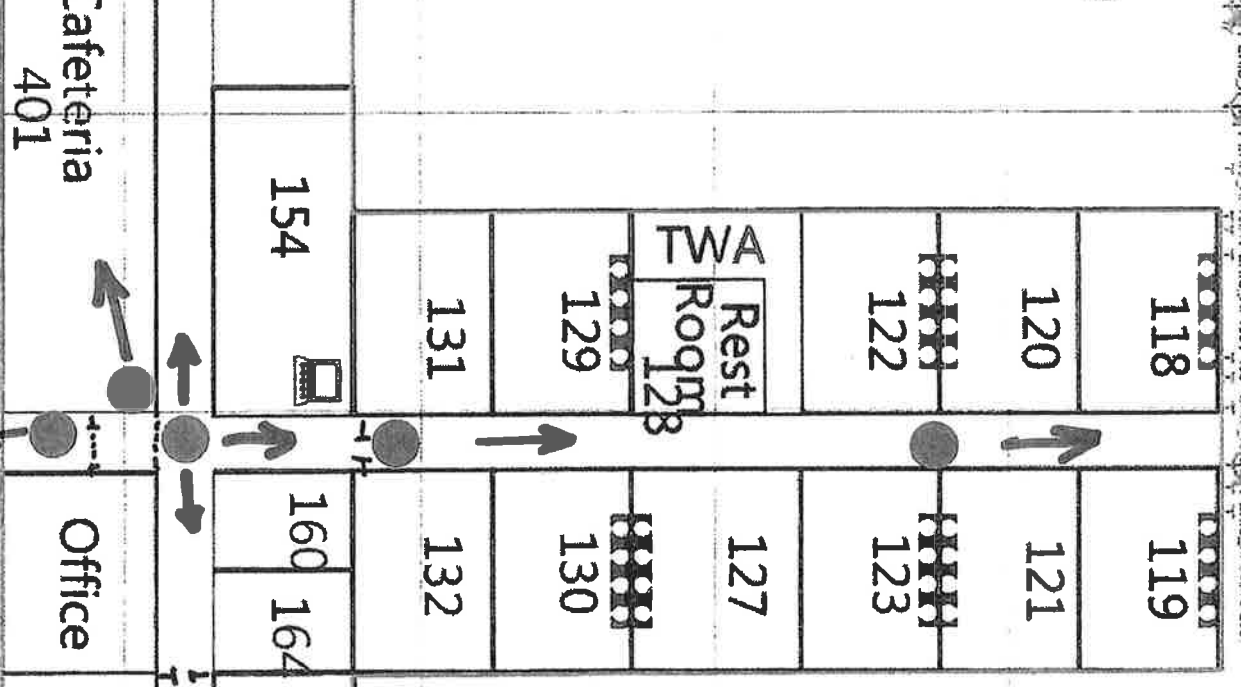

5th Grade

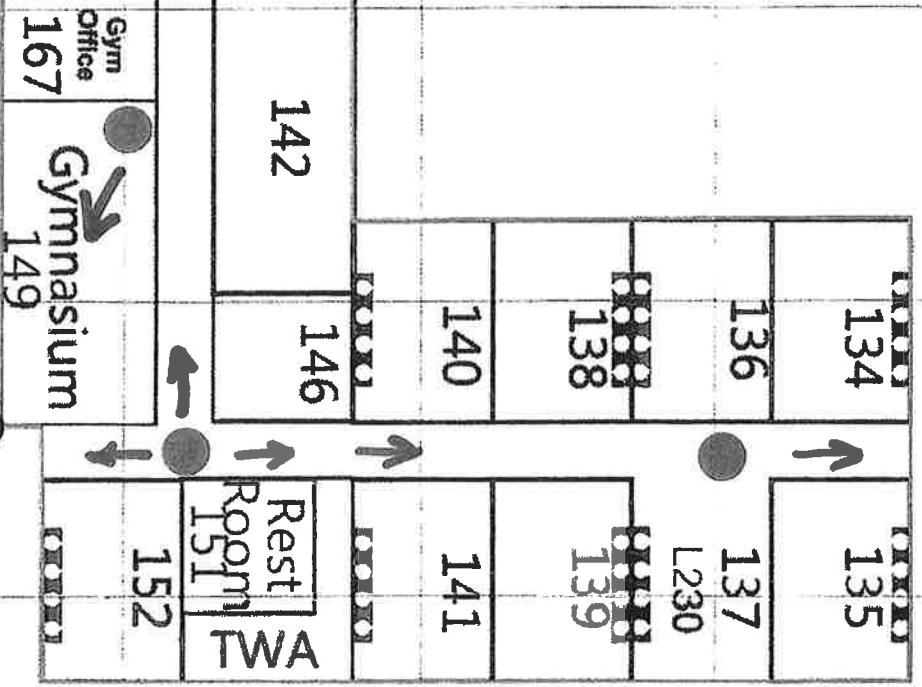

Cafeteria 401

Office

Gym Office 167

Gymnasium 149

35 Classes

TOTAL 15

INTERIOR CLASSROOMS 15

EXTERIOR CLASSROOMS 0



FRONT



FRONT

Michigan County Middle School

- INTERIOR CLY
- EXTERIOR CLY

TOTAL = 20

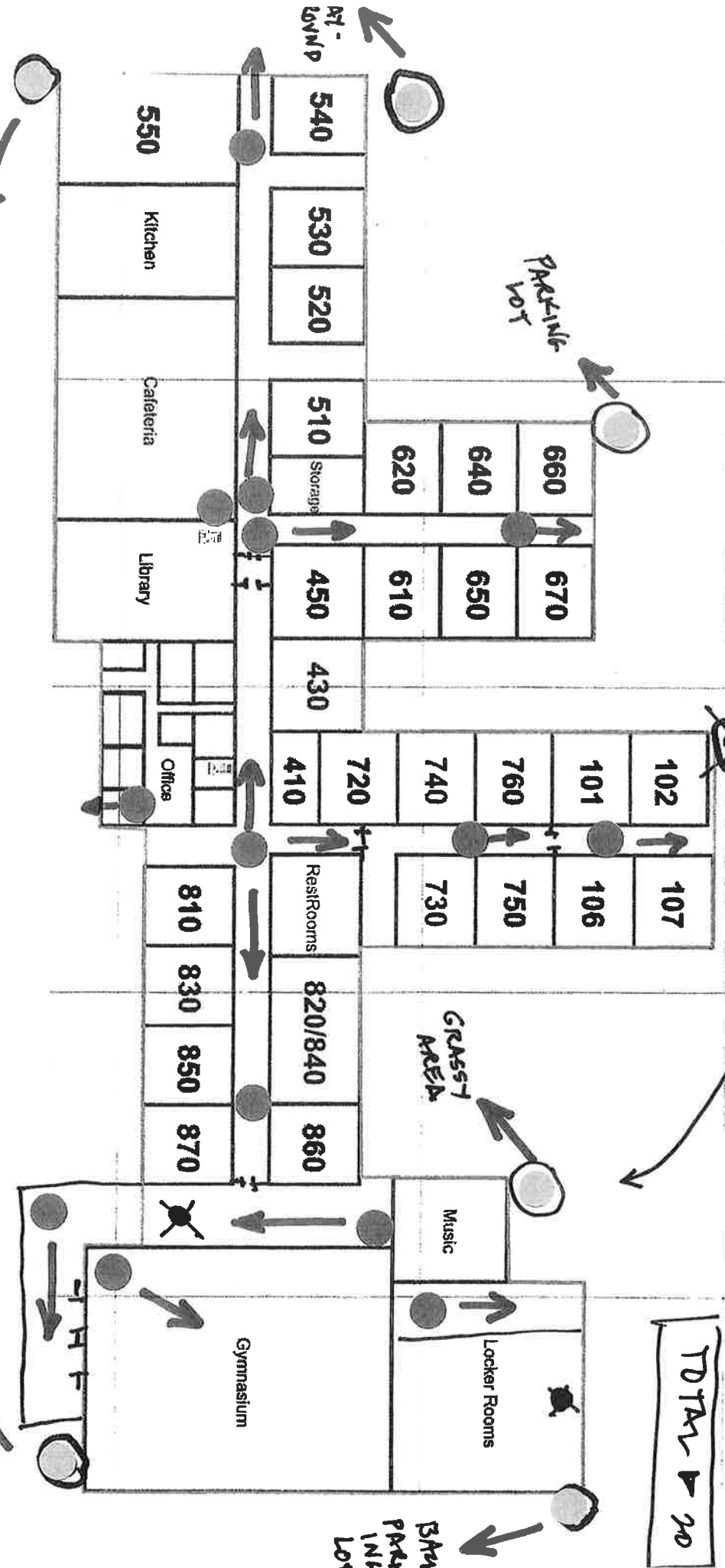

<https://mail.google.com/mail/u/0/#sent/CqMvqmRkGXSnGztdfjHHRhCIBLeVwFALCCHFtLWwCfnhgCDjXwPcniIlgQGSBlmsVxdgNhl?projector=1&messagePartId=0.2>

FRONT

Earl Hickman Middle School

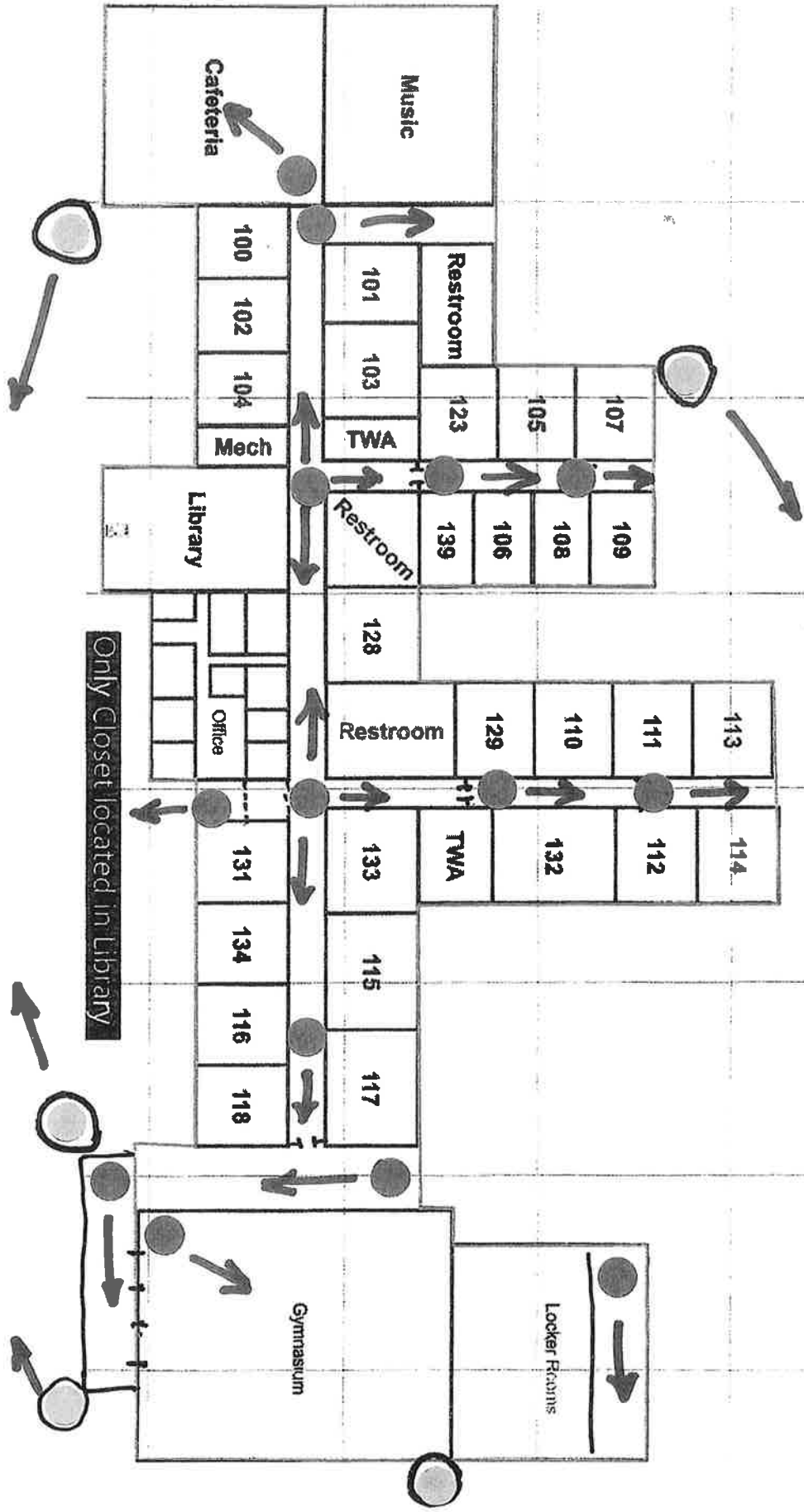



References

Manchester City Schools

215 East Fort Street
Manchester, TN 37355
Mark Howell – (931) 728-2953
howellm1@k12mcs.net

- Avigilon Surveillance System
- Network Infrastructure
- Servers and Computers
- Classroom Technology

Putnam County Schools

3860 Phifer Mountain Road
Cookeville, TN 38506
Johnny Sloan – (931) 520-2100
sloanj2@pcsstn.com

- Network Infrastructure
- Computers
- Classroom Technology

Greeneville City Schools

129 W Depot St
Greeneville, TN 37743
Beverly Miller – (423) 787-8000
millerb@gcschools.net

- Avigilon Surveillance System
- Network Infrastructure
- Computers
- Classroom Technology

Sevier County Schools

311 Bruce Street
Sevierville, TN 37862
Jerry Huskey – (865) 453-4671
jerryhuskey@sevier.org

- Avigilon Surveillance System
- Network Infrastructure
- Servers and Computers
- Classroom Technology
- Managed Services

Bartlett City Schools

5650 Woodlawn Drive
Memphis, TN 38134
Scott Truitt – (901) 202-0855
struitt@bartlettschools.org

- Avigilon Surveillance System
- Network Infrastructure
- Servers and Computers
- Classroom Technology

Lebanon Special School District

701 Coles Ferry Pike
Lebanon, TN 37087
Chris Tenbarga – (615) 453-2694
Tenbargec2@k12tn.net

- Avigilon Surveillance System
- Network Infrastructure
- Servers and Computers

McMinn County Schools

3 South Hill Street
Athens, TN 37303
Jill Pierce – (423) 368-4755
jill@mcminnnschools.com

- Avigilon Surveillance System
- Network Infrastructure
- Servers and Computers
- Classroom Technology

Pickett County Schools

141 Skyline Drive
Byrdstown, TN 38549
Debbie Elder – (931) 864-3123
elderd@k12tn.net

- Avigilon Surveillance System
- Network Infrastructure
- Servers and Computers
- Classroom Technology

Pickett County Schools
141 Skyline Drive, Byrdstown, TN 38549
Diane Elder, Director of Schools
Phone (931) 864-3123
Fax (931) 864-7185

John Reagan, Chairman
Dorman Beaty

Jerry Mitchell
Jimmy Storie

To Whom It May Concern:

When Central Technologies asked me to write this letter of recommendation for them, I did not hesitate. This letter was easy to write, no problem at all.

Central Technologies is not only a company of integrity, they are an outstanding technology solutions provider. Central's team has worked with our district on several projects and has always been dependable, results oriented and most importantly, focused on the needs of the school district. Central provides stellar support and offers state-of-the art technology solutions. Across the board, we are always very pleased with their work. Pickett County Schools can always count on Central Technologies to deliver.

Do yourself a favor, Partner with Central Technologies in your district.

Sincerely,

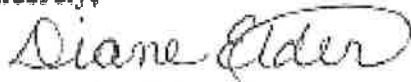

Diane Elder, Director
Pickett County Schools



STATE OF TENNESSEE
DEPARTMENT OF
COMMERCE AND INSURANCE



CENTRAL KNOX, INC. DBA CENTRAL TECHNOLOGIES INC.

ID NUMBER: 2138

LIC STATUS: ACTIVE

EXPIRATION DATE: September 30, 2020

ALARM SYSTEMS CONTRACTORS BOARD
ALARM CONTRACTING COMPANY

THIS IS TO CERTIFY THAT ALL REQUIREMENTS
OF THE STATE OF TENNESSEE HAVE BEEN MET

9351

CENTRAL KNOX, INC. DBA CENTRAL TECHNOLOGIES INC.
6101 INDUSTRIAL HEIGHTS DR NW
KNOXVILLE, TN 37909

9351 1287814

State of Tennessee

ALARM SYSTEMS CONTRACTORS BOARD

ALARM CONTRACTING COMPANY

CENTRAL KNOX, INC. DBA CENTRAL TECHNOLOGIES INC.

GREGORY NEIL SEIBER

This is to certify that all requirements of the State of Tennessee have been met.

ID NUMBER: 2138
LIC STATUS: ACTIVE
EXPIRATION DATE: September 30, 2020



IN-1313
DEPARTMENT OF
COMMERCE AND INSURANCE

State of Tennessee

3404770862348

BOARD FOR LICENSING CONTRACTORS

CONTRACTOR

CENTRAL KNOX, INC.

This is to certify that all requirements of the State of Tennessee have been met.

ID NUMBER: 67550

LIC STATUS: ACTIVE

EXPIRATION DATE: January 31, 2020

AGLM \$1,500,000.00 ; S-Low Voltage NETWORK



IN-1313
DEPARTMENT OF
COMMERCE AND INSURANCE

338702 0769065

State of Tennessee

BOARD FOR LICENSING CONTRACTORS

CONTRACTOR

MODERN ELECTRICAL CONTRACTING, INC.

This is to certify that all requirements of the State of Tennessee have been met.

ID NUMBER: 48005

LIC STATUS: ACTIVE

EXPIRATION DATE: November 30, 2019

AGLM \$700,000.00; CE-A; CE-B; CE-C; CE-D; CE-F; CE-I; CE-J



IN-1313
DEPARTMENT OF
COMMERCE AND INSURANCE



Tennessee Avigilon Customers

Act Management Inc
Alliant Electric
AMD Industries Inc
Anderson County Schools
Antioch Baptist Church
Applied Technology Solutions Inc
Athens City Schools
Bartlett City Schools
Blount County Government
Blount County Schools
Bradley County Schools
Bristol City Schools
Cellular Sales
Chattanooga Area Regional Transportation
City of Pigeon Forge
Cleveland City Schools
Cleveland Housing Authority
Collierville Schools
Consolidated Electronic Systems
Cormetech
Crockett County Schools
Denso Manufacturing
Efficient Energy of Tennessee
Etowah City School
Evans-Ailey Construction Inc
Faith Baptist Church
Fayetteville City Schools
First Baptist Concord
Greeneville City Schools
Gerdau Ameristeel
Knoxville Global Metals
GPS of Chattanooga
Grainger County Schools
Hamilton County Schools
Hardin County Schools
Hawkins County Schools
Helen Ross McNabb Center
HT Hackney
Independent Healthcare Properties
Jackson County Schools
Jefferson County Schools
Kendall Electric Inc
Kilgore Flares
Lebanon SSD
Lefler Electronics
Lenoir City Schools
Lewis Communications
Lincoln County Schools
Loudon County Schools
Manchester City Schools
Marshall County Government
Marshall County Jail
Marshall County Schools
Maury County Schools
McKay's Books
McMinn County Schools
Meigs County Schools
Mid East Community Action Agency
Milan SSD
Millington Municipal Schools
Morgan County Schools
Overton County Schools
Paris SSD
Pickett County Schools
Piggly Wiggly
Putnam County Schools
Regal Entertainment Group
Rhea County Schools
Roane County Schools
Sacred Heart Cathedral
Sevier County Schools
Shields Electronic & Supply Inc
Short Creek Baptist Church
Stop Security
Sullivan County Schools
Tri-Community Fire Department
University School of Jackson
Wesco Distribution Inc
White County Schools



Account & Support Personnel

Account Manager

Joel Mayes
Account Executive
joel@centralinc.com
Direct: 615.920.9226
Toll-Free: 800.315.4132
Fax: 865.312.8190

Managers and Senior Level Supervisors

Doug Carswell
CEO
doug@centralinc.com

Monica Farnar
VP of Client Services
monica@centralinc.com

Gary Rohrer
VP of Technical Solutions
gary@centralinc.com

Todd Troxler
VP of Sales
todd@centralinc.com

Debbie Troxler
Inside Account Manager
debbie@centralinc.com

Joe Alissandrello
Sr. Account Manager
joe@centralinc.com

Ian Arensbak
Operations Manager
ian@centralinc.com

Chris Szito
Service Manager
chszo@centralinc.com

Andy Fadnek, RCDD
General Manager
andy@centralinc.com

Engineers

Josh Beddingfield
Sr. Network Engineer
josh@centralinc.com

Wesley Edwards
Network Engineer
wesley@centralinc.com

Paul Ponziani
Sr. Network Engineer
paul@centralinc.com

Zak Emerick
Sr. Network Engineer
zak@centralinc.com

Technicians

Kevin Blair, RCDD
Technical Engineer
kevin@centralinc.com

Bo Franklin
Operations Manager
bo@centralinc.com

Ben Hurst
Technician
ben@centralinc.com

Lee Grell
Technician
lee@centralinc.com

Branch Support

Central Headquarters
6101 Industrial Heights Drive NW
Knoxville, TN 37909
Phone: 865.566.0230
Toll-Free: 800.315.4132
Fax: 865.312.8190

Central Warehouse – Jackson TN
44 Warehouse Courtyard
Suite 122
Jackson, TN 38301
Toll-Free: 800.315.4132
Fax: 865.312.8190

Central Branch Office – West TN
8549 Cordes Circle, No. 104
Germantown, TN 38139
Phone: 865.566.0230
Toll-Free: 800.315.4132
Fax: 865.312.8190

Compliance with the Buy American Act

Avigilon supports the wording and intent of the Buy American Act on many levels. Depending on your specific use of our technology, and the type of entity you are, different areas of the agreement may apply to your situation. In each case, there are provisions that will allow an organization to purchase and deploy our technology while maintaining the compliance with the Buy American Act and the Federal Acquisition Regulations.

The most prominent area of compliance is under the Federal Acquisition Regulations surrounding the purchasing of "Information Technology". According to the Federal Acquisition Regulations, subpart 25.103 purchasing of information technology is exempt:

"The restriction on purchasing foreign end products does not apply to the acquisition of information technology that is a commercial item, when using fiscal year 2004 or subsequent fiscal year funds."

The Federal Acquisition Regulations Subpart 2.101 defines "information technology":

1. "[A]ny equipment or interconnected system(s) or subsystem(s) of equipment, that is used in the automatic acquisition, storage, analysis, evaluation, manipulation, management, movement, control, display, switching, interchange, transmission, or reception of data or information by the agency."
2. "The term "information technology" includes **computers, ancillary equipment (including imaging peripherals, input, output, and storage devices necessary for security and surveillance)**"

If you would like more details on how Avigilon supports the Buy American Act and the Federal Acquisition Regulations, please contact us at compliance@avigilon.com

Thank you for your interest in Avigilon.

The foregoing is for information purposes only. Under no circumstances is the information contained herein to be construed as legal advice and Avigilon Corporation is not intending for the foregoing to be legal advice. Readers should consult with their own legal advisors for interpretation of the Buy American Act, the Federal Acquisition Regulations and any other applicable laws, rules, regulations or other requirements.

October 23, 2018

To whom it may concern:

Re: Manufacturer Authorization Letter

This letter is to confirm that the company at the address noted below is a certified Avigilon Service Provider and is a Partner in good standing.

Central Knox, Inc. (DBA Central Tech)

PO Box 30867
37930 Knoxville
TN US

In order to be an Avigilon Service Provider in good standing, a company is promptly paying all invoices, has an adequate number of employees who are fully certified as having been trained through Avigilon training programs on how to install and provide first line of support for all Avigilon products, and has completed several Avigilon solution implementations.

This letter is subject to review and renewal on an annual basis, and good standing can be revoked at any time. Please contact the undersigned if you have any questions.

Sincerely,

AVIGILON CORPORATION

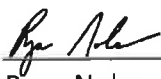
Per: 

Ryan Nolan
Senior Vice President, Business Operations
Office: 214-445-4650

Avigilon Control Center™ 6 Software

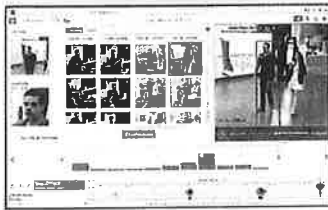

ACC™ software is easy-to-use video management software that optimizes the way security professionals manage and interact with high-definition video. It efficiently captures and stores high-definition video, while intelligently managing bandwidth and storage using our patented High Definition Stream Management (HDSM)™ technology. ACC 6 software combines an intuitive interface with advanced search functions called Avigilon Appearance Search™ video analytics technology and Unusual Motion Detection (UMD). Avigilon Appearance Search technology and UMD are sophisticated deep learning artificial intelligence (AI) search engines that enable users to quickly locate a specific person or vehicle of interest or identify motion anomalies across all sites.

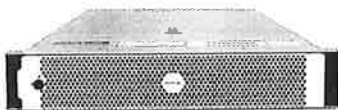

RECORDING NVR PLATFORMS PURPOSE-BUILT FOR ACC SOFTWARE AND AVIGILON APPEARANCE SEARCH TECHNOLOGY

ACC software is pre-installed and configured on HD Video Appliances, HD Network Video Recorders (NVRs), HD NVR Workstations, ACC Edge Solution (ES) HD Recorders, ACC ES Analytics Appliances and the H4 ES camera line. It also works as a stand-alone software, to meet the needs of a wide variety of installations. Our NVRs come pre-installed with a GPU to enable our patented Avigilon Appearance Search technology.



SELF-LEARNING VIDEO ANALYTICS

ACC video management software enables analytics events and alarms to be viewed and searched through an intuitive user interface. Real-time events and forensic capabilities detect and notify scene changes and rules violations.



AVIGILON APPEARANCE SEARCH TECHNOLOGY

Avigilon Appearance Search technology is a sophisticated AI search engine for video data that incorporates the characteristics of a person's face. It sorts through hours of footage with ease, to quickly locate vehicles of interest or people even if items such as their clothing change over time across an entire site with ease. Using Avigilon Appearance Search technology can dramatically improve incident response time and enhance forensic investigations by allowing operators to build robust video evidence and create a powerful narrative of events. Avigilon Appearance Search technology permits users to initiate a search for a person by selecting certain specific physical descriptions. Confirmed matches can now be used to initiate additional searches from other ACC sites.

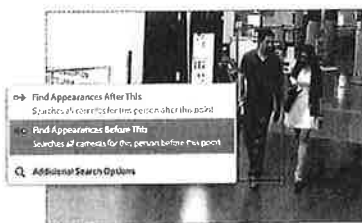

UNUSUAL MOTION DETECTION

UMD is an advanced artificial intelligence (AI) technology that brings a new level of automation to surveillance. Without any predefined rules, UMD technology continuously learns what typical activity in a scene looks like, and then detects and records motion anomalies. UMD is supported by the H4A, H4 SL and H4 Mini Domes camera lines.

Advanced Avigilon Control Center Features



HDSM™ Technology

Efficiently compresses and preserves image quality while intelligently managing HD image transmission throughout the Avigilon system — sending only the requested portions of captured images to operator workstations.



HDSM SmartCodec™ Technology Support

Avigilon HDSM SmartCodec technology automatically optimizes compression levels for regions in a scene, to maximize bandwidth while still maintaining image quality.



Avigilon Appearance Search Technology

Allows you to quickly search recorded video to find instances of a person or vehicle across all sites using cameras with Avigilon self-learning analytics. Search for a person by selecting specific physical descriptions, including upper lower clothing color, hair color and gender.



Intelligent Search

Powerful search tools enable you to quickly search recorded video for motion, the presence of classified objects (people or vehicles), background changes in the scene (thumbnail search), and for events.



Simple Camera and Server Installation

Plug-and-play capabilities for NVRs and cameras that automatically identify themselves on the network, without manual configuration or searching.



Avigilon Presence Detector™ Support

The Avigilon Presence Detector (APD) sensor is a small form factor impulse radar device with self-learning radar analytics that accurately detects the presence of a person even if they have stopped moving or are hidden. It has the ability to detect presence through blankets, cardboard, wood and drywall.



License Plate Recognition (LPR) Analytics

ACC 6.10 and above feature an upgraded LPR analytics engine with easy configuration and improved accuracy for faster security response. Multiple license match lists can each trigger a unique ACC rule on match.



ACM™-ACC interoperability

Receives, processes, and acts on ACM door events, hardware input events, and access grants, enabling operators to unlock access doors directly from a camera view. Identity Verification enables users to see ACM credentials dynamically displayed with ACC camera views. Identity Search enables users to visually verify access events, and initiate an Appearance Search across the entire site for the same person.



Alarm Escalation

Allows the creation of complete end-to-end workflows for the monitoring, assignment, and acknowledgement of alarms.



ACC Mobile Software

Push alarm notifications, live and recorded alarm video, audio talkdown, self-learning video analytics overlays, and digital output triggers for Android™ and iOS mobile devices.



Detailed Management, Monitoring, and Reporting of System Status and Security

Detailed logs of storage, network, and overall system status to ensure the highest possible system uptime for critical applications.



POS Transaction Engine

Link HD surveillance footage (viewed instantly) with transaction data to address compliance requirements and reduce shrinkage and theft.



Scalable Integration with External Systems

Distributed architecture features .NET-based and REST-based APIs that can easily be integrated with other systems, such as access control and building management.



ONVIF® Profile S Conformant VMS

ONVIF profile S conformance ensures interoperability between IP based ONVIF security devices regardless of manufacturer.



Unusual Motion Detection

UMD enables fast video search and is designed to reduce hours of work to minutes by narrowing potentially thousands of motion events to a handful. This allows operators to focus their attention on video footage needing further investigation.



H4 Video Intercom Support

Video Intercom support provides operators with visual and audio verification of visitors. The H4 Video Intercom integration uses wide dynamic range and echo canceling technologies for clear viewing and two-way communication with visitors.

System Architecture

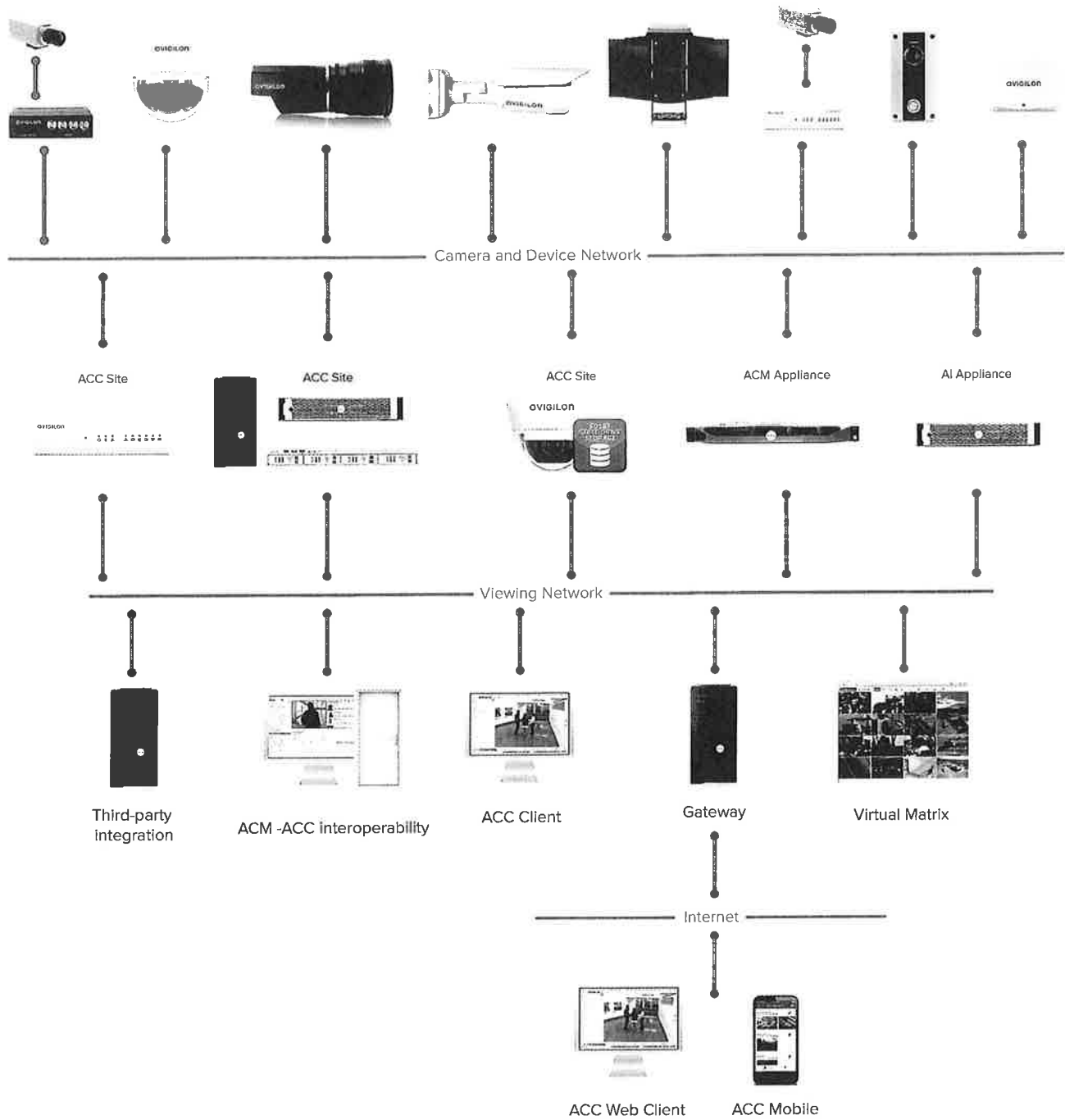

Core, Standard & Enterprise

To create a system most suited for your surveillance needs, the Avigilon Control Center software is offered in three editions: Core, Standard and Enterprise. The Enterprise edition includes more advanced features for a sophisticated solution, whereas the Standard edition is used for more focused needs or for those looking to transition to HD surveillance in a cost-effective way. ACC Core software is an entry-level version of our award-winning software that delivers advanced high definition surveillance capabilities, ease of use, and superior image quality to smaller implementations. No matter what the size of your installation, you can customize a solution that is right for you.



SYSTEM	CORE	STANDARD	ENTERPRISE
Number of cameras per server	24	75	300+
Number of cameras per site	24	75	10 000+
Number of servers per site	1	1	100+
Number of client licenses per server	2	10	Unlimited
High Definition Stream Management (HDSM) Technology	Yes	Yes	Yes
HDSM SmartCodec Technology Support	Yes	Yes	Yes
Dual Streaming for ONVIF compliant cameras	Yes	Yes	Yes
DEVICE SUPPORT	CORE	STANDARD	ENTERPRISE
Automatic device discovery	Yes	Yes	Yes
Third-party IP cameras & encoders	Yes	Yes	Yes
HD Pro cameras	No	No	Yes
Avigilon Presence Detector (APD) sensor	Yes	Yes	Yes
H4 HD cameras with self-learning video analytics	Yes	Yes	Yes
HD cameras with self-learning video analytics	Yes	Yes	Yes
HD Micro Dome, HD Multisensor, HD Panoramic, HD PTZ, IR PTZ, H4 Fisheye, H4 SL cameras, H4 Mini Dome	Yes	Yes	Yes
H4 Video Intercom	Yes	Yes	Yes
ONVIF compliant cameras & encoders	Yes	Yes	Yes
Avigilon encoders	Yes	Yes	Yes
Avigilon Artificial Intelligence Appliance	No	No	Yes
H.264 support	Yes	Yes	Yes
MPEG4 support	Yes	Yes	Yes
MJPEG support	Yes	Yes	Yes
JPEG2000 support	Yes	Yes	Yes
CLIENT	CORE	STANDARD	ENTERPRISE
Powerful, easy-to-use client interface	Yes	Yes	Yes
Video analytics overlays (Self-learning video analytics, Unusual Motion Detection)	Yes	Yes	Yes
Joystick support	Yes	Yes	Yes
ACC Mobile 2 app / HTML5 Web Client / Gateway	Yes	Yes	Yes
ACC Mobile 3 Preview app / Web Endpoint including mobile alarm notifications	Yes	Yes	Yes
Saved views	No	Yes	Yes
Maps with configurable icons and camera thumbnail previews	No	Yes	Yes
Web pages	No	Yes	Yes
Active Directory import	No	No	Yes
Windows user authentication	No	No	Yes
Two Factor Authentication	Yes	Yes	Yes
Password strength meter	Yes	Yes	Yes
Editable Site View	Yes	Yes	Yes
Intelligent Virtual Matrix	No	No	Yes
Collaborative investigations	No	No	Yes
Multi-camera export with optional password protection	Yes	Yes	Yes
Multi-camera privacy blurred export from Appearance Search	No	No	Yes
Live export	Yes	Yes	Yes
Hourly configurable recording schedule	Yes	Yes	Yes

SEARCHING	CORE	STANDARD	ENTERPRISE
Avigilon Appearance Search Technology	No	No	Yes
Search for a person by selecting specific physical descriptions (Gender, Hair color, Upper body clothing color, Lower body clothing color)	No	No	Yes
Search for a person by Identity supplied by ACM	No	Yes	Yes
Unusual Motion Detection Timeline filtering with Skip Play	Yes	Yes	Yes
Intelligent motion search	Yes	Yes	Yes
Thumbnail search	Yes	Yes	Yes
Event search	Yes	Yes	Yes
POS transaction search	No	Yes	Yes
Alarm search	No	No	Yes
License plate event search	No	No	Yes

ADD-ON MODULES AND INTEGRATIONS	CORE	STANDARD	ENTERPRISE
Point of Sale Transaction Engine	No	Yes	Yes
Avigilon developed and supported integrations	No	Yes*	Yes
3rd party system integrations	No	Yes	Yes

*CommScope iPatch, RS2 Accessil, DDS Amadeus 5 and DSX only

AVIGILON'S ACCESS CONTROL MANAGER (ACM) AND ACC SYSTEM INTEROPERABILITY	CORE	STANDARD	ENTERPRISE
ACM system door and panel input event triggers	No	Yes	Yes
ACM system door access grants	No	Yes	Yes
ACM system shared operator access	No	Yes	Yes
ACM Identity Verification	No	Yes	Yes
ACM Identity Search	No	Yes	Yes

ADDITIONAL FEATURES	CORE	STANDARD	ENTERPRISE
E-Mail event notification (motion & system event)	Yes	Yes	Yes
Central station notifications including ANSI/SIA DC-09-2013	No	Yes	Yes
Digital input email trigger	No	Yes	Yes
Manual digital output trigger	No	Yes	Yes
Audio recording	No	Yes	Yes
Audio output	No	Yes	Yes
Rule triggers	No	51	Unlimited
Avigilon Presence Detector event trigger	No	Yes	Yes
Self-learning video analytics event configuration	No	Yes	Yes
Avigilon Artificial Intelligence Appliance analytics configuration	No	No	Yes
Redundant recording	No	No	Yes
Failover connections	No	No	Yes
ACC Client alarm notifications and escalation	No	No	Yes
One-time Video Archive	No	No	Yes
Tiered Storage Management with Continuous Archive	No	No	Yes
License Plate Recognition with multiple match lists	No	No	Yes
Two person authenticated recorded video viewing	Yes	Yes	Yes
Camera Replacement	Yes	Yes	Yes
Standby/Privacy mode for cameras	No	Yes	Yes

For the most current list of integrations and add-ons supported by Avigilon Control Center software, please visit avigilon.com.

System Requirements

NOTE: For all Windows versions, it is recommended that the latest Microsoft service pack is deployed. NVR recording throughput and retention times can vary according to the number of cameras, camera resolution, estimated percent of motion, continuous recording settings and predefined retention period. For full server performance, choose an Avigilon Certified Solution option.

AVIGILON CONTROL CENTER CLIENT SOFTWARE

AVIGILON CERTIFIED SOLUTIONS	DISPLAY MODEL NUMBER	KEY FEATURES
2 Monitor Professional High Performance Remote Monitoring Workstation	HD-RMWS3-2MN	<ul style="list-style-type: none"> • Preloaded with Avigilon Control Center (ACC) Client software. • Supports high resolution monitors. • Includes the adapters and accessories for quick deployment. • Avigilon warranty and support included.
4 Monitor Professional High Performance Remote Monitoring Workstation	HD-RMWS4-4MN	
SOFTWARE SYSTEM REQUIREMENTS	MINIMUM	RECOMMENDED
Operating System	Windows 7 (32-bit or 64-bit), Windows 8.1 (32-bit or 64-bit) or Windows 10 (32-bit or 64-bit) Microsoft .NET 4.6.2	Windows 10 (64-bit) Microsoft .NET 4.6.2
Processor	Intel® dual-core CPU (2.0 GHz)	Intel® Core™ i5 (Quad-core, 3.3 GHz)
System RAM	4 GB DDR3	8 GB DDR4
Video Card	PCI Express, DirectX 10.0 compliant with 256 MB RAM	NVIDIA® Quadro P620
Network Interface	1 Gbps	1 Gbps
Hard Disk Space	500 MB	500 MB

AVIGILON CONTROL CENTER SERVER SOFTWARE

AVIGILON CERTIFIED SOLUTIONS	DISPLAY MODEL NUMBER	KEY FEATURES
HD NVR Premium	HD-NVR4-PRM-64TB / 96TB / 128TB / 157TB	<ul style="list-style-type: none"> • Optimized for video surveillance applications in a 24/7/365 environment • ACC Server software is preinstalled, configured and enhanced for optimal system compatibility • Certified for the Avigilon surveillance environment - ACC software, LPR, Mobile Gateway, Analytics, HDSM and 1-30MP cameras • High throughputs of up to 1800 Mbps • Documented network architecture for a wide variety of applications • Avigilon enhanced warranty and premium support included • Access to Avigilon System Design Tool (SDT) to calculate storage requirements
HD NVR Standard	HD-NVR4-STD-16TB / 24TB / 32TB / 48TB	
HD NVR Value	HD-NVR3-VAL-3TB / 6TB / 12TB / 18TB	
SOFTWARE SYSTEM REQUIREMENTS	MINIMUM	RECOMMENDED
Operating System	Windows Server 2012, Windows Server 2012 R2, Windows 7 (64-bit), Windows 8.1 (64-bit) or Windows 10 (64-bit), Windows Server 2016	Windows Server 2016
Processor	x86 64 bit dual-core (1.9 GHz)	Intel® Xeon® E5 v3 (6 cores, 1.9GHz)
System RAM	4 GB DDR3	16 GB DDR4
Network Interface	1 Gbps	4 x 1 Gbps
Hard Drives	SATA-II 7200 RPM Enterprise Class Hard Drives	SATA-III 7200 RPM Enterprise Class Hard Drives

AVIGILON CONTROL CENTER SERVER WORKSTATION

AVIGILON CERTIFIED SOLUTIONS	DISPLAY MODEL NUMBER	KEY FEATURES
HD Video Appliance	VMA-AS2-8P2 / VMA-AS2-8P4 / VMA-AS2-16P06 VMA-AS2-16P09 / VMA-AS2-16P12 / VMA-AS2-24P12 VMA-AS2-24P18 / VMA-AS2-24P24	<ul style="list-style-type: none"> • Preloaded and configured with Avigilon Control Center (ACC) video management software • High-performance recording capacity • Throughputs of up to 400 Mbps • Avigilon warranty and support included • Access to Avigilon System Design Tool (SDT) to calculate storage requirements
ACC ES HD Recorder	VMA-RPO-4P2 / VMA-RPO-4P4	
ACC ES Analytics Appliance	VMA-RPA-4P2 / VMA-RPA-4P4	
HD NVR Workstation	HD-NVRWS3-8TB	
SOFTWARE SYSTEM REQUIREMENTS	MINIMUM	RECOMMENDED
Operating System	Windows Server 2012, Windows Server 2012 R2, Windows 7 (64-bit), Windows 8.1 (64-bit) or Windows 10 (64-bit)	Windows 10 (64-bit)
Processor	Intel Quad-core CPU (2.0 GHz)	Intel Core i5 (Quad-core, 3.3 GHz)
System RAM	4 GB DDR3	8 GB DDR4
Network Interface	1 Gbps	1 Gbps
Video Card	PCI Express, DirectX 10.0 compliant with 256 MB RAM	NVIDIA Quadro P620
Hard Drives	SATA-II 7200 RPM Hard Drives	SATA-III 7200 RPM Hard Drives

AVIGILON APPEARANCE SEARCH TECHNOLOGY

Avigilon Appearance Search technology requires the ACC Analytics Service to be installed on the same computer as the ACC Server software, and must meet the listed system requirements:

AVIGILON CERTIFIED SOLUTIONS	DISPLAY MODEL NUMBER
Analytics Kit for Avigilon Appearance Search Software	HD-NVR-ANK2-1

KEY FEATURES

Tested and verified to provide enough processing power to run Avigilon Appearance Search feature.

SOFTWARE SYSTEM REQUIREMENTS

NVIDIA CUDA Compute Capability	5.0 or above; Windows x86_64 Driver Version 397.44 or above
GPU Memory	4 GB or above

AVIGILON CONTROL CENTER GATEWAY

Avigilon Control Center Gateway can be installed on the same computer as the ACC Server software, but for optimal performance results it is recommended that the Gateway be installed separately. The Gateway can handle up to 36 concurrent video streams if installed on a computer with the listed requirements (with recommended specs).

SOFTWARE SYSTEM REQUIREMENTS	MINIMUM	RECOMMENDED
Operating System	Windows Server 2016, Windows Server 2012, Windows Server 2012 R2, Windows 7 (64-bit), Windows 8.1 (64-bit) or Windows 10 (64-bit) Microsoft .NET 4.6.2	Windows 10 (64-bit) Microsoft .NET 4.6.2
Processor	Intel quad-core CPU (2.0 GHz)	Intel Core i5 (Quad-core, 3.3 GHz)
System RAM	4 GB DDR3	8 GB DDR4
Hard Disk Space	500 MB	500 MB

AVIGILON CONTROL CENTER WEB CLIENT

Avigilon Control Center Web Client can be accessed from the listed web browsers.

Web Browsers	Internet Explorer version 9.0 or later Chrome version 20 or later	Firefox® version 15 or later Safari version 9.0 or later
--------------	--	---

AVIGILON CONTROL CENTER MOBILE 2.X SOFTWARE

Avigilon Control Center Mobile (ACC Mobile) version 2.x is currently only available for the listed device platforms.

Platforms	Android version 5.x or later	iPad with iOS 7 or later iPhone with iOS 7 or later iPod touch with iOS 7 or later
-----------	------------------------------	--

AVIGILON CONTROL CENTER MOBILE 3.X SOFTWARE PREVIEW

ACC Mobile version 3.x is currently only available for the listed device platforms and requires the ACC Web Endpoint software. The ACC Web Endpoint software comes pre-installed on ACC ES HD Recorder and ACC ES Analytics Appliance. For NVR systems and HD Video Appliances, it should be installed on the same server as the ACC Server software.

Platforms	Android version 5.0 or later	iPad with iOS 10 or later iPhone with iOS 10 or later iPod touch with iOS 10 or later
Processor	n/a	64-bit (Apple A7 or later)

AVIGILON CONTROL CENTER LPR PLUGIN

Avigilon Control Center LPR Plugin is supported on the listed operating systems.

Operating System	Windows Server 2012, Windows Server 2012 R2, Windows 7 (64-bit), Windows 8.1 (64-bit) or Windows 10 (64-bit), Windows Server 2016
------------------	---

Avigilon certified solutions are recommended for LPR solutions.

H4 Mini Dome Camera

The H4 Mini Dome is the smallest and most discreet camera within the Avigilon H4 platform, ideal for space-constrained applications requiring a minimal footprint surveillance camera. The innovative and modular design of this camera line allows it to snap into surface, in-ceiling, or pendant mount adaptors to easily fit challenging installations. This camera line provides exceptional image quality, LightCatcher[™] technology, dual exposure true Wide Dynamic Range (WDR) and adaptive IR on selected variants, all at an entry level price point. Using HDSM SmartCodec[™] technology, Idle Scene Mode technology and patented High Definition Stream Management[™] technology, H4 Mini Dome cameras minimize bandwidth and storage requirements, while maintaining a high-quality image.

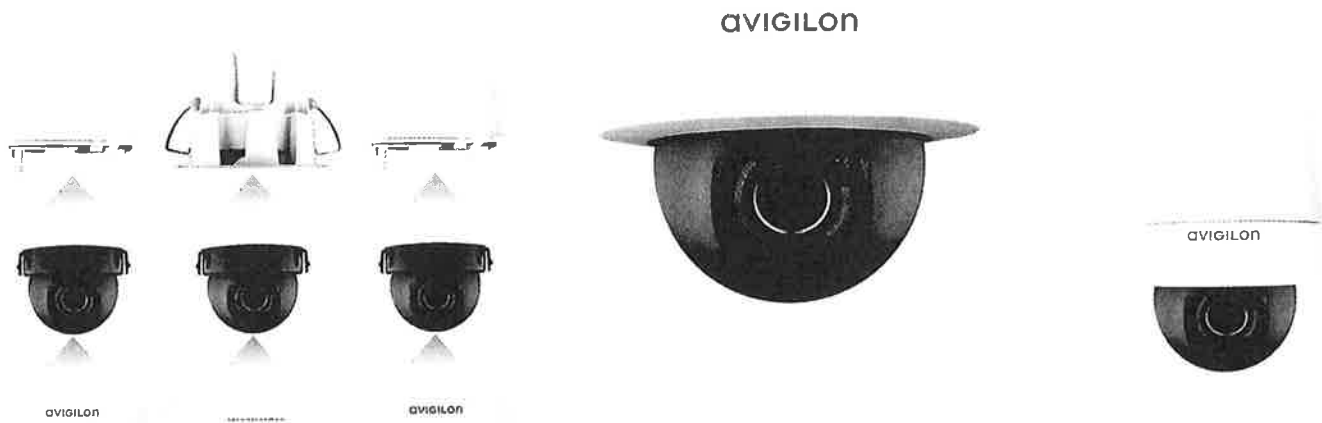

Standard surface mount model has a footprint of only 2.9 inches, extending 2.0 inches from the installation surface. The optional in-ceiling adapter offers a profile of only 1.5 inches, with a footprint of 3.5 inches. This camera line is ideal for space-constrained or discreet applications while providing an aesthetically pleasing solution for indoor environments such as hallways, public entrances and lobbies of banks, schools, retail outlets and hotels.

H4 Mini Dome's state-of-the-art modular design allows it to snap into your choice of base, easily switching between surface, in-ceiling, and pendant mounts. This design reduces installation time and provides flexibility to installers. The optional black accessories provide further customization to match the environment.

Combining the powers of our HDSM[™], HDSM SmartCodec, and Idle scene mode technologies along with the easy to install modular design, the H4 Mini Dome camera line provides a reliable security solution with minimal total cost of ownership.

KEY FEATURES

- 1.3, 2.0 and 3.0 megapixel resolution models
- Fixed 2.8mm, f1.2 lens
- Small, discreet form factor ideal for indoor applications
- Innovative modular design for quick and easy installation
- Content adaptive IR technology provides effective illumination through the field of view, while maintaining exceptional scene illumination
- Avigilon LightCatcher technology provides exceptional image quality in low light environments
- Dual exposure Wide Dynamic Range for complex lighting environments
- Integrated IR LEDs provide uniform illumination in the dark, even at 0 lux, up to maximum of 10m (32ft) IR on selected models
- Avigilon HDSM SmartCodec Idle scene mode technology for reduced bandwidth and storage requirements
- Integrates with Avigilon Control Center[™] video management software (VMS), and is ONVIF-compliant for integration with a third party VMS.

Specifications

		1.3 MP	2.0 MP	3.0 MP
IMAGE PERFORMANCE	Image Sensor	1/2.8" Progressive Scan CMOS		
	Aspect Ratio	5:4	16:9	4:3
	Active Pixels (H x V)	1280 (H) x 1024 (V)	1920 (H) x 1080 (V)	2048 (H) x 1536 (V)
	Imaging Area (H x V)	3.7 mm x 3.0 mm, 0.145" x 0.118"	5.6 mm x 3.1 mm; 0.22" x 0.122"	5.12 mm x 3.84 mm; 0.202" x 0.157"
	Imaging Rate	30 fps	30 fps	20 fps
	Minimum Illumination	With IR 0.01 lux in color mode; 0 lux (F/1.2) in monochrome mode Without IR 0.01 lux in color mode; 0.002 lux (F/1.2) in monochrome mode		0.02 lux in color mode; 0 lux (F/1.2) in monochrome mode 0.02 lux in color mode; 0.004 lux (F/1.2) in monochrome mode
	IR Illumination	10 m (33 ft) max. distance at 0 lux		
	Dynamic Range	100 dB		
	Resolution Scaling	Down to 384 x 216		
	3D Noise Reduction Filter	Yes		
LENS	Lens	2.8mm, F1.2, IR Corrected		
	(Aspect Ratio) HFOV	(5:4) 74°; (16:9) 110°		(5:4) 94°; (16:9) 100°; (4:3) 100°
IMAGE CONTROL	Image Compression Method	H.264 (MPEG-4 Part 10/AVC), Motion JPEG		
	Streaming	Multi-stream H.264 and Motion JPEG		
	Bandwidth Management	HDSM; HDSM SmartCodec; Idle Scene Mode		
	Motion Detection	Pixel		
	Tamper Detection	Yes		
	Electronic Shutter Control	Automatic, Manual (1/6 to 1/8000 sec)		
	Iris Control	Fixed		
	Day/Night Control	Automatic, Manual		
	Flicker Control	50 Hz, 60 Hz		
	White Balance	Automatic, Manual		
NETWORK	Backlight Compensation	Adjustable		
	Privacy Zones	Up to 64 zones		
	Network	100BASE-TX		
	Cabling Type	CAT5		
	Connector	RJ-45		
	ONVIF	ONVIF compliant with version 1.02, 2.00, Profile S		
	Security	Password protection, HTTPS encryption, digest authentication, WS authentication, user access log, 802.1x port based authentication		
	Protocols	IPv6, IPv4, HTTP, HTTPS, SOAP, DNS, NTP, RTSP, RTCP, RTP, TCP, UDP, IGMP, ICMP, DHCP, Zeroconf, ARP		
	Streaming Protocols	RTP/UDP, RTP/UDP multicast, RTP/RTSP/TCP, RTP/RTSP/HTTP/TCP, RTP/RTSP/HTTPS/TCP, HTTP		
	Device Management Protocols	SNMP v2c, SNMP v3		
MECHANICAL		SURFACE MOUNT	IN-CEILING MOUNT	PENDANT MOUNT
	Dimensions (LxWxH)	73 mm x 73 mm x 52 mm; 2.9" x 2.9" x 2.0"	89 mm x 89 mm x 39 mm; 3.5" x 3.5" x 1.5"	73 mm x 73 mm x 113mm; 2.9" x 2.9" x 4.4"
	Max. Ceiling Thickness	n/a	1.0"	n/a
	Cable Assembly Length	24cm; 9.4"		
	Weight	H4M-D1 - 118 g, 0.26 lbs	H4M-D1 - 152 g, 0.34 lbs	H4M-D1 - 162 g, 0.35 lbs
	Body	Polycarbonate and aluminum		
	Housing	Recessed mount	Surface mount, Max. Ceiling Thickness 1.0"	Pendant mount, Female 1/2" NPT Thread
	Finish	Cool grey, black		
Adjustment Range	360° pan, -5° to 75° tilt, ±115° azimuth			
ELECTRICAL	Power Consumption	4W		
	Power Source	PoE: IEEE802.3af Class 2 compliant		
	RTC Backup Battery	3V manganese lithium		
ENVIRONMENTAL	Operating Temperature	0 °C to 50 °C (32 °F to 122 °F)		
	Storage Temperature	-30 °C to 70 °C (-22 °F to 158 °F)		
	Humidity	0 - 95% non-condensing		
	Environment	Indoor Applications		
CERTIFICATIONS	Certifications/Directives	UL, cUL, CE, ROHS, WEEE, RCM, EAC, KC		
	Safety	UL 62368-1, CSA 62368-1, IEC/EN 62368-1, IEC 62471		
	Electromagnetic Emissions	FCC Part 15 Subpart B Class B, IC ICES-003 Class B, EN 55032 Class B, EN 61000-6-3, EN 61000-3-2, EN 61000-3-3, KN 32		
	Electromagnetic Immunity	EN 55024, EN 61000-6-1, EN 50130-4, KN 35		

Outline Dimensions

[X.X]	MM
X	INCHES

Surface

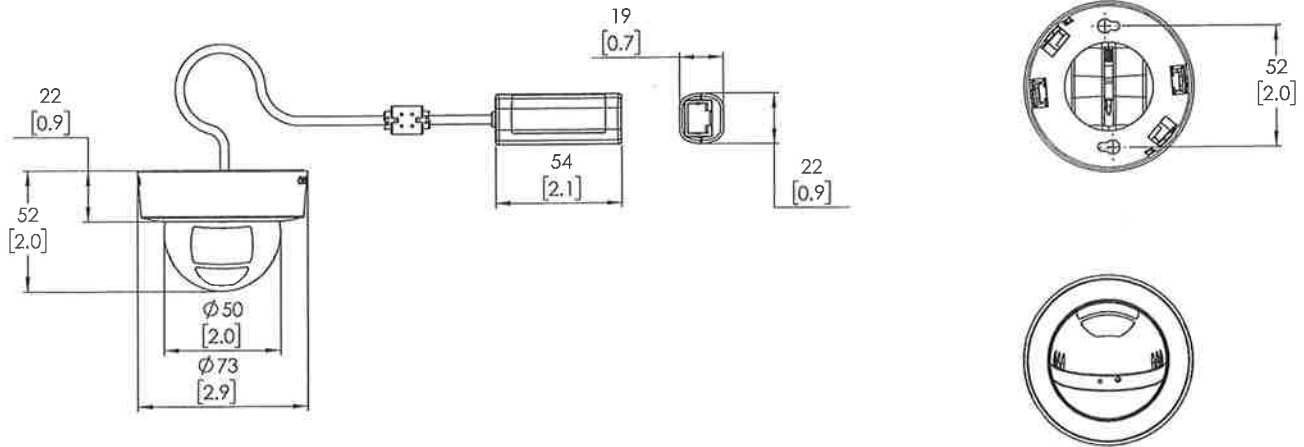

In Ceiling

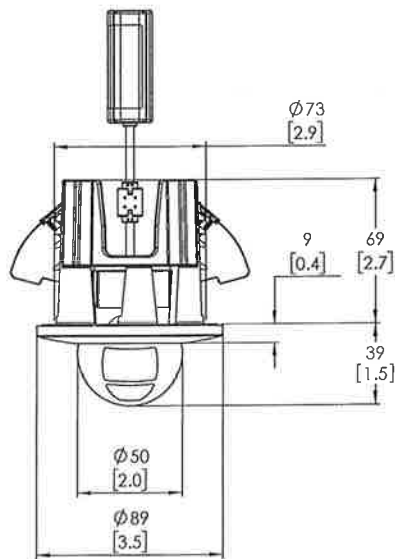

Pendant

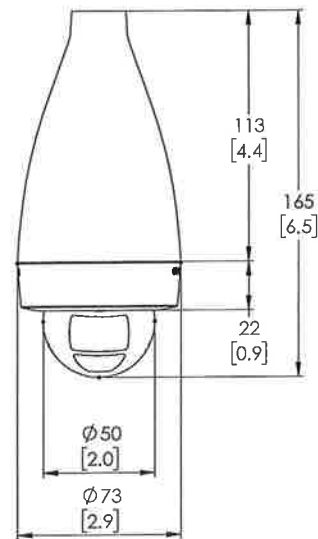

Ordering Information

	MP	WDR	LightCatcher Technology	Lens	IR	HDSM SmartCodec
1.3C-H4M-D1	1.3	✓	✓	2.8 mm		✓
1.3C-H4M-D1-IR	1.3	✓	✓	2.8 mm	✓	✓
2.0C-H4M-D1	2	✓	✓	2.8 mm		✓
2.0C-H4M-D1-IR	2	✓	✓	2.8 mm	✓	✓
3.0C-H4M-D1	3	✓	✓	2.8 mm		✓
3.0C-H4M-D1-IR	3	✓	✓	2.8 mm	✓	✓
H4M-BZL-BL1	Package of 5 black surface mount bezels for H4M dome cameras					
H4M-MT-DCIL1	In-ceiling mount adapter for H4M dome cameras					
H4M-MT-DCIL1-BL	Black in-ceiling mount adapter for H4M dome cameras					
H4M-MT-NPTA1	Pendant mount adapter for H4M dome cameras					
H4M-MT-NPTA1-BL	Black pendant mount adapter for H4M dome cameras					

H4 SL Bullet Camera with LightCatcher[™] Technology

The H4 SL camera line has an innovative and modular design that is easy to install. Built on the H4 platform, it combines our patented LightCatcher and Wide Dynamic Range (WDR) technologies to provide exceptional image quality in complex lighting. Using HDSM SmartCodec[™] and idle scene mode technologies, the H4 SL camera optimizes video streams in real time, minimizing bandwidth and storage requirements while maintaining clear, detailed images. It integrates with Avigilon Control Center[™] video management software (VMS), and is ONVIF-compliant for integration with a third-party VMS. With significant improvements to bandwidth savings and lower storage retention, as well as its easy-to-install, modular design, the H4 SL camera line adds even more value than before, lowering your total cost of ownership.

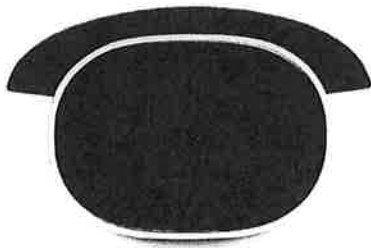

Straight out of the box, the H4 SL camera is designed and packaged for simple ordering and quick and flexible installation. The discreet and modular design of this camera line allows it to seamlessly fit in to its surroundings. Bullet models have interchangeable brackets for maximum flexibility in mounting options, they can be vertically or horizontally-mounted with a versatile sunshade for unobstructed views.

The H4 SL camera's IK10-rated, vandal-resistant and IP66 dust and water-resistant housing make it ideal for monitoring a variety of indoor and outdoor environments, such as hallways, public entrances and lobbies of banks, schools, retail outlets and hotels.

Avigilon HDSM SmartCodec technology H4 SL optimizes the video stream in real time using automatic ROI encoding to save bandwidth and storage requirements while maintaining image quality.

KEY FEATURES

- 1.3, 2.0 and 3.0 megapixel resolution models
- Innovative modular design for quick and easy installation
- 3-9 mm F/1.4 lens with remote zoom and focus
- Content adaptive IR technology provides effective illumination through the field of view, while maintaining exceptional scene illumination
- Wi-Fi camera configuration support
- Avigilon LightCatcher technology provides exceptional image quality in low light environments
- Dual exposure Wide Dynamic Range for complex lighting environments
- Integrated IR (Infrared) LEDs provide uniform illumination in the dark, even at 0 lux, up to maximum of 15m (~50ft) away (outdoor model only)
- Avigilon HDSM SmartCodec technology for reduce bandwidth and storage requirements
- Idle scene mode lowers bandwidth and storage usage if there are no motion events detected in the scene
- IK10 vandal resistant construction and IP66 compliant
- Avigilon HDSM SmartCodec technology for reduce bandwidth and storage requirements

Specifications

		1.3 MP	2.0 MP	3.0 MP
IMAGE PERFORMANCE	Image Sensor	1/2.8" progressive scan CMOS		
	Aspect Ratio	5:4	16:9	4:3
	Active Pixels (H x V)	1280 x 1024	1920 x 1080	2048 x 1536
	Imaging Area (H x V)	3.7 mm x 3.0mm; 0.145" x 0.118"	5.6 mm x 3.1 mm; 0.22" x 0.122"	5.12 mm x 3.84 mm; 0.202" x 0.157"
	Imaging Rate	30 fps	30 fps	20 fps
	IR Illumination (high power 850 nm LEDs)	15 m (50 ft) max. distance at 0 lux		
	Minimum Illumination	0.01 lux (F/1.4) in color mode; 0 lux (F/1.4) in monochrome mode with IR		0.02 lux in color mode; 0 lux (F/1.4) in monochrome mode with IR
	Dynamic Range	100 dB		
	Resolution Scaling	Down to 384 x 216		
	Bandwidth Management	HDSM SmartCodec technology; Idle scene mode		
3D Noise Reduction Filter	Yes			
LENS	Lens	F/1.4, 3-9 mm, motorized, varifocal		
	(Aspect ratio) HFoV	(5:4) 26° – 60°; (16:9) 39° – 90°		(5:4) 36° – 84°; (16:9) 39° – 90°; (4:3) 39° – 90°
IMAGE CONTROL	Image Compression Method	H.264 (MPEG-4 Part 10/AVC), Motion JPEG		
	Streaming	Multi-stream H.264 and Motion JPEG		
	Video Compression	H.264/MJPEG/HDSM SmartCodec technology		
	Motion Detection	Pixel		
	Tamper Detection	Yes		
	Electronic Shutter Control	Automatic, Manual (1/6 to 1/8000 sec)		
	Iris Control	Automatic, Manual		
	Day/Night Control	Automatic, Manual		
	Flicker Control	50 Hz, 60 Hz		
	White Balance	Automatic, Manual		
	Backlight Compensation	Adjustable		
	Privacy Zones	Up to 64 zones		
NETWORK	Network	100BASE-TX		
	Cabling Type	CAT5		
	Connector	RJ-45		
	ONVIF	ONVIF compliant with version 1.02, 2.00, Profile S		
	Security	Password protection, HTTPS encryption, digest authentication, WS authentication, user access log, 802.1x port based authentication		
	Protocols	IPv6, IPv4, HTTP, HTTPS, SOAP, DNS, NTP, RTSP, RTCP, RTP, TCP, UDP, IGMP, ICMP, DHCP, Zeroconf, ARP		
	Streaming Protocols	RTP/UDP, RTP/UDP multicast, RTP/RTSP/TCP, RTP/RTSP/HTTP/TCP, RTP/RTSP/HTTPS/TCP, HTTP		
	Device Management Protocols	SNMP v2c, SNMP v3		
PERIPHERALS	USB Port	USB 2.0		
	Onboard Storage	microSD/microSDHC/microSDXC slot – minimum class 6; class 10/UHS-1 or better recommended		
MECHANICAL	Dimensions (LxWxH)	285 mm x 131 mm x 97mm; 11.2" x 5.1" x 3.8" (including mounting bracket)		
	Weight Camera:	1.29 kg (2.84 lbs)		
	Mounting Bracket:	0.21 kg (0.46 lbs)		
	Body	Aluminum		
	Housing	Surface mount, tamper resistant, vandal resistant		
	Finish	Powder coat, cool grey		
Adjustment Range	±175° pan, ±90° tilt, ±175° azimuth			
ELECTRICAL	Power Consumption	9W max		
	Power Source	PoE: IEEE802.3af Class 3 compliant		
	RTC Backup Battery	3V manganese lithium		
ENVIRONMENTAL	Operating Temperature	-30 °C to +60 °C (-22 °F to 140 °F)		
	Storage Temperature	-10 °C to +70 °C (14 °F to 158 °F)		
	Humidity	0 - 95% non-condensing		
CERTIFICATIONS	Certifications/Directives	UL, cUL, CE, ROHS, WEEE, RCM, EAC, KC		
	Safety	UL 60950-1, CSA 60950-1, IEC/EN 60950-1, IEC 62471		
	Environmental	IK10 Impact Rating, UL/CSA/IEC 60950-22, IEC 60529 IP66 Rating		
	Electromagnetic Emissions	FCC Part 15 Subpart B Class B, IC ICES-003 Class B, EN 55032 Class B, EN 61000-6-3, EN 61000-3-2, EN 61000-3-3, KN 32, EN 55011		
	Electromagnetic Immunity	EN 50121-4, EN 55024, EN 61000-6-1, EN 50130-4, KN 35		

Outline Dimensions

HD Bullet Camera

(H4SL-BO-IR)

LANDSCAPE
MODE

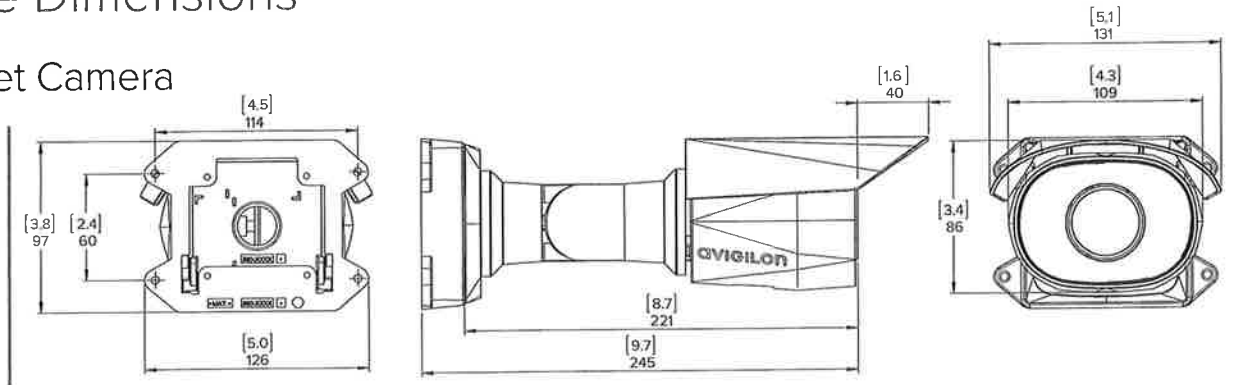

HALLWAY
MODE

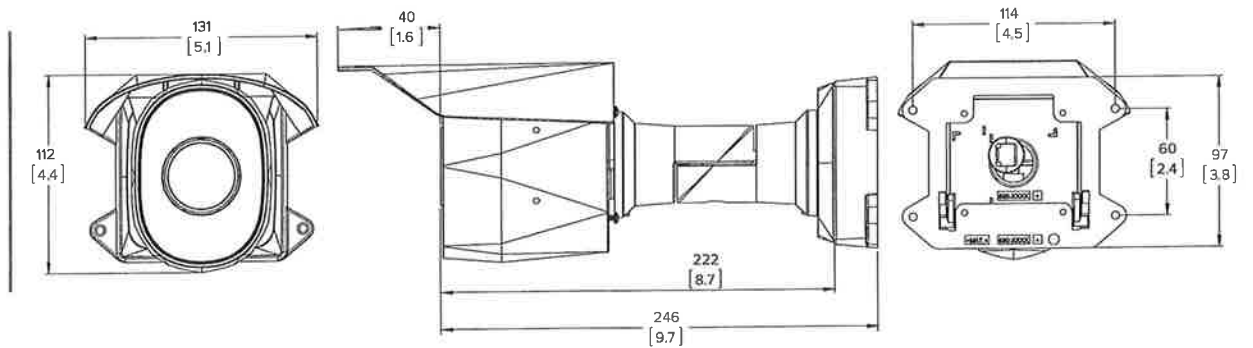

HD Bullet Camera Junction Box

(H4-BO-JBOX1)

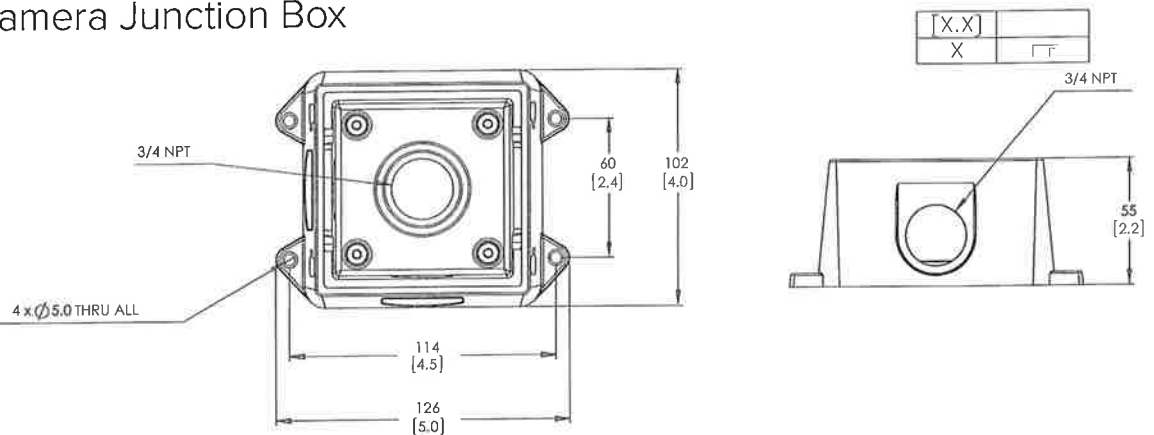

Ordering Information

	MP	WDR	LightCatcher Technology	Lens	IR	IP66	HDSM SmartCodec
1.3C-H4SL-BO1-IR	1.3	✓	✓	3 - 9 mm	✓	✓	✓
2.0C-H4SL-BO1-IR	2.0	✓	✓	3 - 9 mm	✓	✓	✓
3.0C-H4SL-BO1-IR	3.0	✓	✓	3 - 9 mm	✓	✓	✓
H4-BO-JBOX1	Junction box for H4 HD and H4 SL bullet cameras						
H4-MT-POLE1	Aluminum pole mounting bracket						
H4-MT-CRNR1	Aluminum corner mounting bracket						
H4-AC-WIFI2-NA	USB Wi-Fi adapter						
H4-AC-WIFI2-EU	USB Wi-Fi adapter						

H4 SL Dome Camera with LightCatcher[™] Technology

The H4 SL camera line has an innovative and modular design that is easy to install. Built on the H4 platform, it combines our patented LightCatcher and Wide Dynamic Range (WDR) technologies to provide exceptional image quality in complex lighting.

Using HDSM SmartCodec[™] and idle scene mode technologies, the H4 SL camera optimizes video streams in real time, minimizing bandwidth and storage requirements while maintaining clear, detailed images. It integrates with Avigilon Control Center[™] video management software (VMS), and is ONVIF-compliant for integration with a third-party VMS. With significant improvements to bandwidth savings and lower storage retention, as well as its easy-to-install, modular design, the H4 SL camera line adds even more value than before, lowering your total cost of ownership.

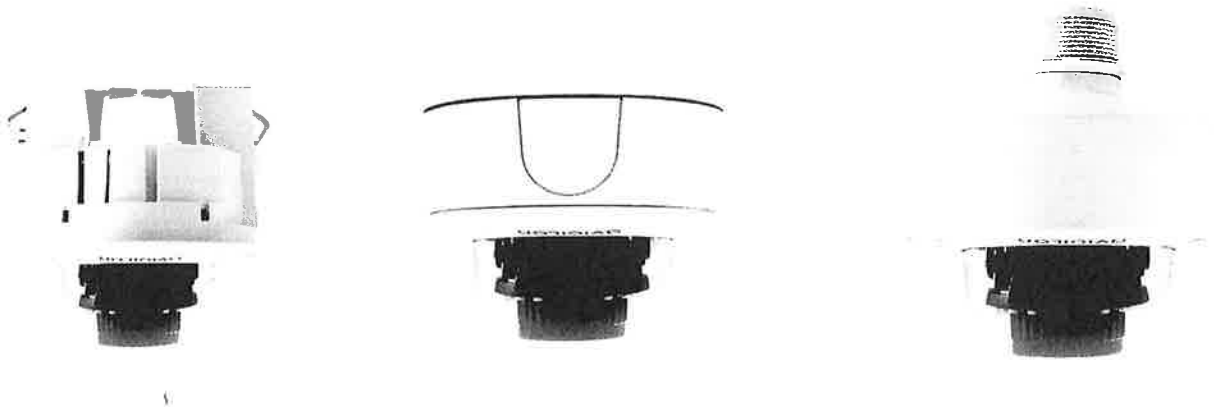

Straight out of the box, the H4 SL camera is designed and packaged for simple ordering and quick and flexible installation. This camera line's discreet and modular design allows it to seamlessly fit in to its surroundings.

The H4 SL camera's IK10-rated, vandal-resistant and IP66 dust and water-resistant housing (outdoor model only) make it ideal for monitoring a variety of indoor and outdoor environments, such as hallways, public entrances and lobbies of banks, schools, retail outlets and hotels.

Avigilon HDSM SmartCodec technology H4 SL optimizes the video stream in real time using automatic ROI encoding to save bandwidth and storage requirements while maintaining image quality.

KEY FEATURES

- 1.3, 2.0 and 3.0 megapixel resolution models
- Innovative modular design for quick and easy installs
- 3-9 mm F/1.4 lens with remote zoom and focus
- Content adaptive IR technology provides effective illumination through the field of view, while maintaining exceptional scene illumination
- Wi-Fi camera configuration support
- Avigilon LightCatcher technology provides exceptional image quality in low light environments
- Dual exposure Wide Dynamic Range for complex lighting environments
- Integrated IR (Infrared) LEDs provide uniform illumination in the dark, even at 0 lux, up to maximum of 15 m (~50 ft) away (outdoor model only)
- Avigilon HDSM SmartCodec technology for reduce bandwidth and storage requirements
- Idle scene mode lowers bandwidth and storage usage if there are no motion events detected in the scene
- (Outdoor model only) IK10 vandal resistant construction and IP66 compliant

Specifications

		1.3 MP	2.0 MP	3.0 MP	
IMAGE PERFORMANCE	Image Sensor	1/2.8" progressive scan CMOS			
	Aspect Ratio	5:4	16:9	4:3	
	Active Pixels (H x V)	1280 x 1024	1920 x 1080	2048 x 1536	
	Imaging Area (H x V)	3.7 mm x 3.0mm; 0.145" x 0.118"	5.6 mm x 3.1 mm; 0.22" x 0.122"	5.12 mm x 3.84 mm; 0.202" x 0.157"	
	Image Rate	30 fps	30 fps	20 fps	
	Minimum Illumination	with IR 0.01 lux in color mode; 0 lux (F/1.4) in monochrome mode without IR 0.01 lux in color mode; 0.002 lux (F/1.4) in monochrome mode		0.02 lux in color mode; 0 lux (F/1.4) in monochrome mode 0.02 lux in color mode; 0.004 lux (F/1.4) in monochrome mode	
	IR Illumination (high power 850 nm LEDs)	(H4SL-D) Indoor model — 10 m (33 ft) max. distance at 0 lux (H4SL-DO) Outdoor model — 15 m (50 ft) max. distance at 0 lux			
	Dynamic Range	100 dB			
	Resolution Scalling	Down to 384 x 216			
	Bandwidth Management	HDSM SmartCodec technology; Idle scene mode			
LENS	3D Noise Reduction Filter	Yes			
	Lens (Aspect ratio) HFoV	F/1.4, 3-9 mm, motorized, varifocal (5:4) 26° – 60°; (16:9) 39° – 90°		(5:4) 36° – 84°; (16:9) 39° – 90°; (4:3) 39° – 90°	
IMAGE CONTROL	Image Compression Method	H.264 (MPEG-4 Part 10/AVC), Motion JPEG			
	Streaming	Multi-stream H.264 and Motion JPEG			
	Video Compression	H.264/MJPEG/HDSM SmartCodec technology			
	Motion Detection	Pixel			
	Tamper Detection	Yes			
	Electronic Shutter Control	Automatic, Manual (1/6 to 1/8000 sec)			
	Iris Control	Automatic, Manual			
	Day/Night Control	Automatic, Manual			
	Flicker Control	50 Hz, 60 Hz			
	White Balance	Automatic, Manual			
NETWORK	Backlight Compensation	Adjustable			
	Privacy Zones	Up to 64 zones			
	Network	100BASE-TX			
	Cabling Type	CAT5			
	Connector	RJ-45			
	ONVIF	ONVIF compliant with version 1.02, 2.00, Profile S			
	Security	Password protection, HTTPS encryption, digest authentication, WS authentication, user access log, 802.1x port based authentication			
	Protocols	IPv6, IPv4, HTTP, HTTPS, SOAP, DNS, NTP, RTSP, RTCP, RTP, TCP, UDP, IGMP, ICMP, DHCP, Zeroconf, ARP			
	Streaming Protocols	RTP/UDP, RTP/UDP multicast, RTP/RTSP/TCP, RTP/RTSP/HTTP/TCP, RTP/RTSP/HTTPS/TCP, HTTP			
	Device Management Protocols	SNMP v2c, SNMP v3			
PERIPHERALS	USB Port	USB 2.0			
	Onboard Storage	microSD/microSDHC/microSDXC slot – minimum class 6; class 10/UHS-1 or better recommended			
MECHANICAL		SURFACE MOUNT	IN-CEILING MOUNT	PENDANT MOUNT	
				NPT ADAPTER	
				NPT + WALL MOUNT	
	Dimensions (LxWxH)	147 mm x 147 mm x 119 mm; 5.8" x 5.8" x 4.7"	174 mm x 174 mm x 162 mm; 6.9" x 6.9" x 6.4"	153 mm x 153 mm x 166 mm; 6.0" x 6.0" x 6.5"	269 mm x 153 mm x 214 mm; 10.6" x 6.0" x 8.4"
	Max. Ceiling Thickness	n/a	32 mm (1.25")	n/a	n/a
	Weight	H4SL-D — 0.76 kg; 1.68 lbs H4SL-DO — 0.78 kg; 1.72 lbs	H4SL-D — 0.75 kg; 1.65 lbs H4SL-DO — 0.77 kg; 1.69 lbs	H4SL-D — 0.75 kg; 1.65 lbs H4SL-DO — 0.77 kg; 1.69 lbs	H4SL-D — 2.02 kg; 4.45 lbs H4SL-DO — 2.04 kg; 4.49 lbs
	Dome Bubble	Polycarbonate, clear			
	Body	Polycarbonate			Polycarbonate/aluminum
	Housing	Vandal resistant			
	Finish	Fog coat, cool grey			Powder coat, RAL 9003
Adjustment Range	360° pan, ±180° azimuth, 30° – 95° tilt (recommended), 10° – 95° tilt (maximum),				
ELECTRICAL	Power Consumption	H4SL-D — 4 W max H4SL-DO — 7 W max			
	Power Source	PoE: IEEE802.3af Class 3 compliant			
	RTC Backup Battery	3V manganese lithium			
ENVIRONMENTAL	Operating Temperature	Outdoor: -30 °C to +60 °C (-22 °F to 140 °F); Indoor: 0 °C to +60 °C (32 °F to 140 °F)			
	Storage Temperature	-10 °C to +70 °C (14 °F to 158 °F)			
	Humidity	0 - 95% non-condensing			
CERTIFICATIONS	Certifications/Directives	UL, cUL, CE, ROHS, WEEE, RCM, EAC (not applicable to 3MP indoor dome), KC			
	Safety	UL 60950-1, CSA 60950-1, IEC/EN 60950-1, IEC 62471			
	Environmental	(H4SL-DO outdoor models only) IK10 Impact Rating, UL/CSA/IEC 60950-22, IEC 60529 IP66 Rating			
	Electromagnetic Emissions	FCC Part 15 Subpart B Class B, ICES-003 Class B, EN 55032 Class B, EN 61000-6-3, EN 61000-3-2, EN 61000-3-3, EN 55032, KN 32, EN 55011			
Electromagnetic Immunity	EN 55024, EN 61000-6-1, EN 50130-4, KN 35				

Outline Dimensions

Surface Mount

(H4SL-D / H4SL-DO + provided surface mount)

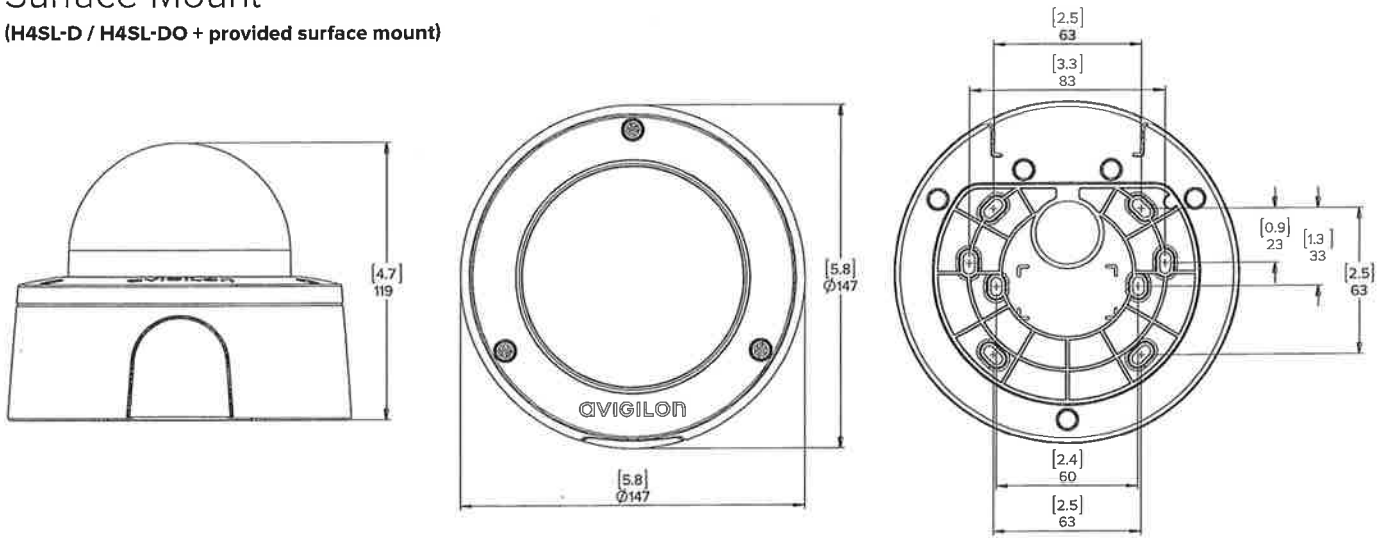

In-Ceiling Mount

(H4SL-D/H4SL-DO + H4SL-MT-DCIL)

[X.X]	INCHES
X	MM

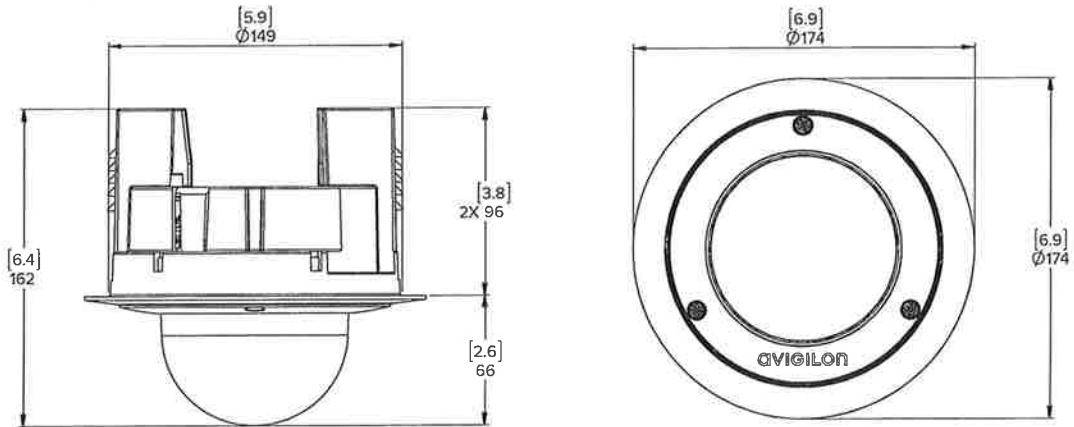

NPT Adapter

(H4SL-D/H4SL-DO + H4SL-MT-NPTA)

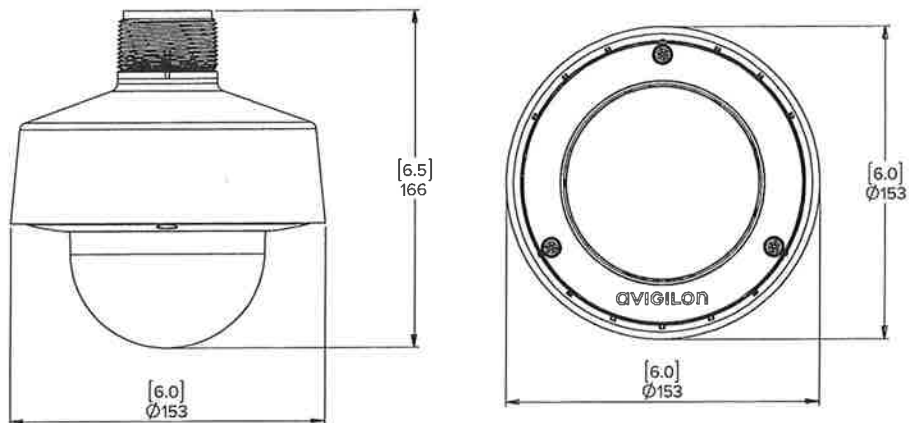

NPT Adapter and Pendant Wall Mount

(H4SL-D/H4SL-DO + H4SL-MT-NPTA + CM-MT-WALL1)

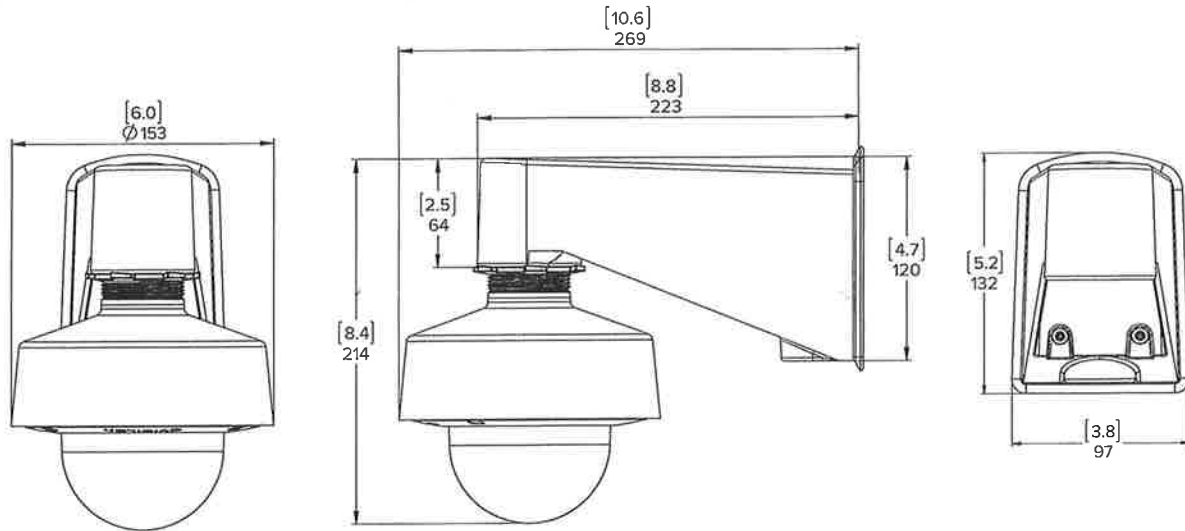

Ordering Information

	MP	WDR	LightCatcher Technology	Lens	IR	IP66	HDSM SmartCodec
1.3C-H4SL-D1	1.3	✓	✓	3 - 9 mm			✓
2.0C-H4SL-D1	2.0	✓	✓	3 - 9 mm			✓
3.0C-H4SL-D1	3.0	✓	✓	3 - 9 mm			✓
1.3C-H4SL-D1-IR	1.3	✓	✓	3 - 9 mm	✓		✓
2.0C-H4SL-D1-IR	2.0	✓	✓	3 - 9 mm	✓		✓
3.0C-H4SL-D1-IR	3.0	✓	✓	3 - 9 mm	✓		✓
1.3C-H4SL-DO1-IR	1.3	✓	✓	3 - 9 mm	✓	✓	✓
2.0C-H4SL-DO1-IR	2.0	✓	✓	3 - 9 mm	✓	✓	✓
3.0C-H4SL-DO1-IR	3.0	✓	✓	3 - 9 mm	✓	✓	✓

H4SL-MT-DCIL1	In-ceiling mounting adapter for the H4 SL dome camera
H4SL-MT-NPTA1	NPT adapter for the H4 SL dome camera
CM-MT-WALL1	Pendant wall mount
H4-DC-CPNL1	Metal ceiling panel
H4-MT-POLE1	Aluminum pole mounting bracket
H4-MT-CRNR1	Aluminum corner mounting bracket
H4-AC-WIFI2-NA	USB Wi-Fi adapter
H4-AC-WIFI2-EU	USB Wi-Fi adapter
H4SL-DD-SMOK1	Replacement outdoor smoke dome cover
H4SL-DD-CLER1	Replacement outdoor clear dome cover
H4SL-DI-SMOK1	Replacement indoor smoke dome cover
H4SL-DI-CLER1	Replacement indoor clear dome cover
H4SL-DO1-BASE	Replacement outdoor surface mount adapter
H4SL-D1-BASE	Replacement indoor surface mount adapter

HD NVR3 Value

Avigilon HD Network Video Recorders (NVRs) provide secure, reliable and scalable platforms for high performance end-to-end security solutions. Our network security recorders have Avigilon Control Center (ACC) software preloaded and configured for plug-and-play network video recording and management of multi-megapixel IP cameras, up to our industry-leading 7K (30 megapixel) HD Pro.



The Avigilon HD NVR3 Value is a 1U rack mountable recorder specifically manufactured for the Avigilon ecosystem. It leverages the full power of Avigilon Control Center (ACC) software to deliver high performance and retention at a lower cost of ownership. The NVR3 Value meets the requirements of IP video and video analytics metadata storage. It's backed by the Avigilon three-year warranty, which provides businesses with support and onsite parts delivery for continuous recording and retention of video while minimizing disruptions to security operations.

The HD NVR3 Value is an out-of-the-box, ready-to-deploy video recording platform designed for single site surveillance or to be distributed across multiple remote sites.

KEY FEATURES

- Preloaded and configured with ACCTM video management software
- High performance of up to 384 Mbps of total throughput – simultaneous recording, playback, and live streaming
- Highly scalable capacity options — up to 18TB of recording for long-term video retention
- Hot-swappable components maintain video recording and playback operations even in the event of multiple component failures
- An easy to access and maintain 1U rack mount chassis — includes a sliding rail kit and cable management system
- Avigilon Appearance SearchTM technology support with an optional kit
- A three-year warranty with onsite parts delivery service

Specifications

SYSTEM	Video Management Software	Avigilon Control Center™ – compatible with Enterprise, Standard and Core editions	
	Network	Network Connection	1 GbE - with multiple network connections
	Video Streaming Performance*	Recording Data Rate	Up to 256 Mbps
		Playback and Live Streaming	Up to 128 Mbps (while simultaneously recording video)
		Recording Storage Capacity	Up to 24 TB raw, 18 TB effective (RAID 5)
		Avigilon Appearance Search Capacity	Up to 30 cameras**
		Hard Disk Drive Configuration	Video data — 4 x large form factor hard disk drives, hot-swappable, RAID 5
		Network Interface	2 x 1 GbE RJ-45 ports (1000Base-T)
		Memory	8 GB DDR4
		Operating System	Microsoft Windows 10 IoT Enterprise LTSB
		Processor	Intel® Xeon®
		Video Outputs	2 x VGA
		Local Viewing	No
		Remote Access	iDRAC8 Express
	<p>* These performance figures are based on validation testing by Avigilon, using Avigilon Control Center software. For more information, contact Avigilon Sales. ** Requires optional GPU kit, ACC enterprise license and Avigilon H4A analytic enabled cameras. The Avigilon Appearance Search camera support limit does not affect any NVR throughputs for simultaneous recording, playback and live streaming.</p>		
MECHANICAL	Form Factor	1U rack mount chassis	
	Dimensions (LxWxH)	with bezel	674.7 mm x 482.4 mm x 42.95 mm; 26.56" x 18.99" x 1.69"
	Weight		13.8 kg (30.42 lb)
ELECTRICAL	Power Input	100 to 240 V AC, 50/60 Hz, autoranging	
	Power Supply	Single — optional secondary power supply available	
	Power Consumption	350 W (1194.2 BTU/hr)	
ENVIRONMENTAL	Operating Temperature	10°C to 35°C (50°F to 95°F) with no direct sunlight on the equipment	
	Storage Temperature	-40° C to 65° C (-40° F to 149° F)	
	Operating Humidity	10% to 80% Relative Humidity with 29°C (84.2°F) maximum dew point	
	Storage Humidity	5% to 95% RH with 33°C (91°F) maximum dew point. Atmosphere must be non-condensing at all times	
	Operating Vibration	0.26 Grms at 5 Hz to 350 Hz	
	Storage Vibration	1.88 Grms at 10 Hz to 500 Hz for 15 min	
	Operating Shock	Six consecutively executed shock pulses in the positive and negative x, y, and z axes of 40 G for up to 2.3 ms	
	Storage Shock	Six consecutively executed shock pulses in the positive and negative x, y, and z axes (one pulse on each side of the system) of 71 G for up to 2 ms	
	Operating Altitude	3,048 m (10,000 ft)	
Storage Altitude	12,000 m (39,370 ft)		
SUPPLIED ACCESSORIES	Rack Rail System	Sliding rail system with cable management arm. Supports: <ul style="list-style-type: none"> • Tool-less mounting in 19"-wide EIA-310-E compliant square hole and unthreaded round-hole 4-post racks • Toolled mounting in threaded hole 4-post racks 	
	Bezel	1, front	
	Power Cords	1	
CERTIFICATIONS	Safety	EN 60950-1:2006 / A1:2009 / A1:2010 / A12:2011 / A2:2013 EN 62311:2008	UL/CSA/IEC 60950-1, 2 Ed + Am 1: 2009 + Am 2: 2013
	Power Efficiency	80 PLUS Platinum	ENERGY STAR 2.0
	Electromagnetic Emissions	US CFR Title 47, FCC Part 2, 15 Canadian ICES-003(A) Issue 5 EN 55022:2010/CISPR 22:2010	EN 61000-3-2:2006 +A1:2009 +A2:2009/IEC 61000-3-2:2005 +A1:2008 +A2:2009 (Class D) EN 61000-3-3:2008/ IEC 61000-3-3:2008
	Electromagnetic Immunity Directives	EN 55024:2010/CISPR 24:2010	
		RoHS, Reach (SVHC), WEEE	

Outline Dimensions

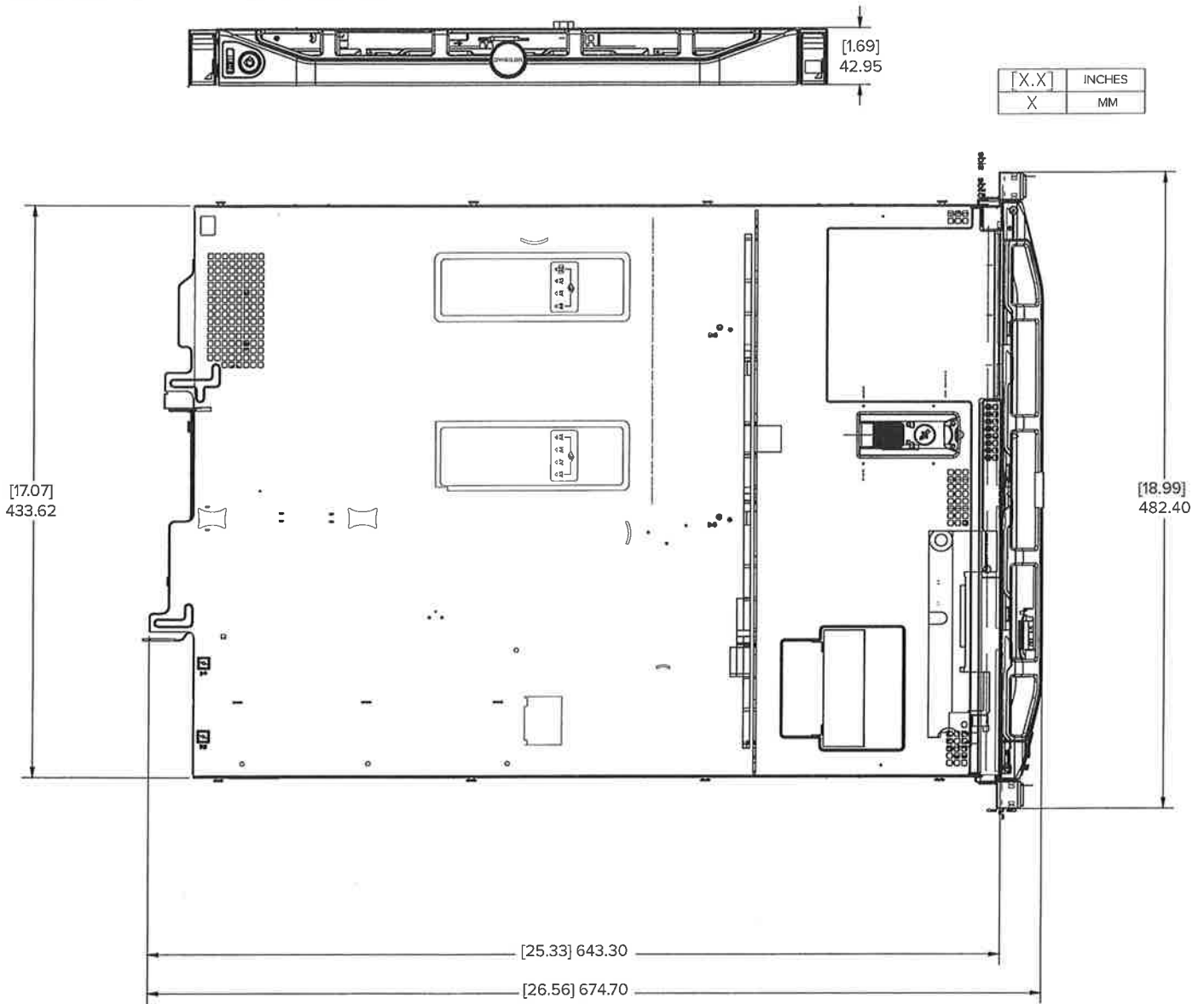

Ordering Information

- HD-NVR3-VAL-3TB 3 TB HD NVR3 Value with Microsoft Windows 10 Enterprise Embedded and Avigilon Control Center
 - HD-NVR3-VAL-6TB 6 TB HD NVR3 Value with Microsoft Windows 10 Enterprise Embedded and Avigilon Control Center
 - HD-NVR3-VAL-12TB 12 TB HD NVR3 Value with Microsoft Windows 10 Enterprise Embedded and Avigilon Control Center
 - HD-NVR3-VAL-18TB 18 TB HD NVR3 Value with Microsoft Windows 10 Enterprise Embedded and Avigilon Control Center
- Avigilon Control Center licenses must be purchased separately

- HD-NVR-ANK2-1 Analytics Kit for Avigilon Appearance Search software
- HD-NVR3-VAL-2NDPS-AU Redundant, hot-swappable power supply, for AU
- HD-NVR3-VAL-2NDPS-EU Redundant, hot-swappable power supply, for EU
- HD-NVR3-VAL-2NDPS-NA Redundant, hot-swappable power supply, for NA
- HD-NVR3-VAL-2NDPS-UK Redundant, hot-swappable power supply, for UK
- HD-NVR3-VAL-WARR-EXTEND-2YR 2 year warranty extension - HD NVR3 VAL
- HD-NVR3-VAL-WARR-EXTEND-1YR 1 year warranty extension - HD NVR3 VAL

HD-NVR3-VAL-xxTB-NA =



HD-NVR3-VAL-xxTB-UK =



HD-NVR3-VAL-xxTB-EU =



HD-NVR3-VAL-xxTB-AU =





Greetings!

BGCSystems is an IT company specializing in the sales and service of commercial businesses and educational institutions in the Tennessee, Kentucky, and Southeast Missouri areas.

Currently, we hold bids with several Tennessee and Southeast Missouri school districts and are equipped to complete and fulfill any hardware needs that your organization is facing or may face in the future.

In this packet, we have included a list of our references as well as all the contact information you need to reach me and my team.

Please let me know if you have any questions for me. We greatly appreciate the opportunity to work with you and hope we will have that chance in the future!

Sincerely,

A handwritten signature in black ink, appearing to read 'MB', with a long, sweeping underline that extends to the right.

Matthew Barnes
President



**Services Included in
Unit Pricing/Notes to Bid**

**ATTENTION:
Hickman County Finance Office
114 North Central Avenue
Suite 203
Centerville, TN 37033**

**FROM:
Bluegrass Computer Systems, LLC
174 Saundersville Road, Suite 501
Hendersonville, TN 37075**

SUBJECT: Security Camera System Bid

Non-Technical Acknowledgements/ Notes

- 1) Equipment is all brand-new and not refurbished.
- 2) BGCSystems acknowledges that net 30 terms is to be extended for all purchases.
- 3) BGCSystems acknowledges that the school district is exempt of all sales taxes.
- 4) BGCSystems promises to provide delivery of all goods within 15 days of Purchase Order date. This statement is provided that all products are in manufacture "stock". Certain items may require longer periods of time for delivery. Estimates are available before purchase if requested.
- 5) All Orders will be delivered to the school location of choice FOB.

- 6) All Pricing Guaranteed from March 18th, 2019 until September 18th, 2019.
- 7) BGCSystems has been in operation since 2010 and operates in multiple states and was awarded Ingram Micro's SMB Award as being the 12th fastest growing IT company in the nation for periods of 2012-2015. Proof of Financial and Business Capability is available per request.
- 8) BGCSystems will NOT subcontract in any way.
- 9) BGCSystems allows full Cooperative Purchasing with all government and education entities within the state of TN.
- 10) BGCSystems carries \$4,000,000 of General Liability Insurance, \$500,000 of Professional Liability Insurance and will name the school district as an additional insured if requested. BGCSystems carries full worker's compensation insurance on all employees and can provide proof if request.
- 11) BGCSystems is providing a toll free number, (877) 909-0515
- 12) BGCSystems maintains their corporate sales and service office in Hendersonville, TN.
- 13) BGCSystems has provided very competitive pricing that is based on reasonable quantity order as recorded by sales history to other districts that compare to the student population of the school district. However, additional discounts may be offered for additional quantities.
- 14) Length of Years in Business: 8 total years with direct focus of K-12 Education in the Missouri and Tennessee markets.
- 15) BGCSystems holds and maintains a business license in Hickman County, Tennessee.

- 16) Warranty/Service Experience: School District. may request warranty service through our help desk at (877) 909-0515, by emailing max@bgcsystems.com or by submitting a warranty ticket at the BGCSystems Online Client Portal. BGCSystems will work directly with the manufacture to provide warranty assistance. School District will NOT have to call manufacture directly for any type of support, however, a toll free support line to each manufacture will be made available to the district if the district wishes.
- 17) Vendor Help Desk: BGCSystems Help Desk is available from 8am to 5pm Monday- Friday at (877) 909-0515. Additional time may be requested at no additional charge for after hour or weekend support. The BGCSystems Online Client Portal will be available to the district 24 hours a day, 7 days a week. The Client Portal will allow for warranty tickets to be created, help desk (general questions) tickets to be created and provide a custom knowledgebase of articles pertaining to products owned by the school district.
- 18) BGCSystems has provided detailed explanation of compliance of bid specification on this document, however in addition, BGCSystems provides a blanket compliance of all bid specifications as outlined in the bid packet.
- 19) BGCSystems agrees to purchase and secure and bid, performance, and/or payment bonds as requested by school district.
- 20) Please consider our services, listed below, that are included free of charge in each of our bid prices.

School Security Camera Systems - Hickman County Schools

Bid Form and Specifications/Scope of Work

The following Bid Form and Specifications/Scope of Work are to be used to submit bids by school.

Complete Pricing on this FORM and return with BID:

**Camera Types: (cost should include any related licensing)
(All cameras must be network capable)**

Licensing not included in camera price, each camera requires 1 license @ \$79.00

Camera Type	Price	Licensing
Single HD Dome Camera:	\$299.00	\$79.00
Multi-position HD Camera: (minimum of 4 views)	\$1,049.00	\$79.00
HD PTZ Camera:	\$899.95	\$79.00
HD Bullet:	\$559.00	\$79.00

Installation and all related materials

School	Installation Cost (including all related materials)	Other related Cost (please provide specifics on a separate sheet)
Centerville Elementary	\$185.00	See attached Estimate
East Elementary	\$185.00	See attached Estimate
Centerville Intermediate	\$185.00	See attached Estimate
East Intermediate	\$185.00	See attached Estimate
Hickman County Middle School	\$185.00	See attached Estimate
East Hickman Middle School	\$185.00	See attached Estimate



Estimate

Date	Estimate #
3/7/2019	CES

174 Saundersville Road
 Suite 501
 Hendersonville, TN 37075

(615) 761-9040

Name / Address
Hickman County Board of Education Mr. Brad Gilbert 115 Murphree Avenue Centerville, TN 37033

Project

Description	Qty	Rate	Total
Axis M3105-L HD Dome Network Camera, 3 Year Warranty	11	299.00	3,289.00T
Axis P3707-PE HD Network Camera- Includes 4 2MP Cameras that allow multi-position, 3 Year Warranty	3	1,049.00	3,147.00T
Axis P1435 Bullet Camera HD, 3 Year Warranty	8	559.00	4,472.00T
Axis T91B47 Pole Mount-Required for Front Entrance and Cafe	2	85.00	170.00T
Axis Camera Station Manager License	22	79.00	1,738.00T
CAT6 Network Drop- Cable Labor to run cable in drop ceiling, terminate to PoE Switch and attach camera to ceiling tile, includes mounting supplies and tools.	22	185.00	4,070.00

Subtotal	\$16,886.00
Sales Tax (0.0%)	\$0.00
Total	\$16,886.00



Estimate

Date	Estimate #
3/7/2019	CIS

174 Saundersville Road
 Suite 501
 Hendersonville, TN 37075

(615) 761-9040

Name / Address
Hickman County Board of Education Mr. Brad Gilbert 115 Murphree Avenue Centerville, TN 37033

Project

Description	Qty	Rate	Total
Axis M3105-L HD Dome Network Camera, 3 Year Warranty	3	299.00	897.00T
Axis P3707-PE HD Network Camera- Includes 4 2MP Cameras that allow multi-position, 3 Year Warranty	3	1,049.00	3,147.00T
Axis P1435 Bullet Camera HD, 3 Year Warranty	7	559.00	3,913.00T
Axis T91B47 Pole Mount-Required for Front Entrance and Cafe	2	85.00	170.00T
Axis Camera Station Manager License	13	79.00	1,027.00T
CAT6 Network Drop- Cable Labor to run cable in drop ceiling, terminate to PoE Switch and attach camera to ceiling tile, includes mounting supplies and tools.	13	185.00	2,405.00
		Subtotal	\$11,559.00
		Sales Tax (0.0%)	\$0.00
		Total	\$11,559.00



Estimate

Date	Estimate #
3/7/2019	HCMS

174 Saundersville Road
 Suite 501
 Hendersonville, TN 37075

(615) 761-9040

Name / Address
Hickman County Board of Education Mr. Brad Gilbert 115 Murphree Avenue Centerville, TN 37033

Project

Description	Qty	Rate	Total
Axis M3105-L HD Dome Network Camera, 3 Year Warranty	8	299.00	2,392.00T
Axis P3707-PE HD Network Camera- Includes 4 2MP Cameras that allow multi-position, 3 Year Warranty	2	1,049.00	2,098.00T
Axis M5525-E IP Camera HD PTZ Camera, 3 Year Warranty	1	899.95	899.95T
Axis T91L61 Wall Mount-Required for Gym	1	99.00	99.00T
Axis P1435 Bullet Camera HD, 3 Year Warranty	7	559.00	3,913.00T
Axis T91B47 Pole Mount-Required for Front Entrance and Cafe	2	85.00	170.00T
Axis Camera Station Manager License	18	79.00	1,422.00T
CAT6 Network Drop- Cable Labor to run cable in drop ceiling, terminate to PoE Switch and attach camera to ceiling tile, includes mounting supplies and tools.	18	185.00	3,330.00
		Subtotal	\$14,323.95
		Sales Tax (0.0%)	\$0.00
		Total	\$14,323.95



Estimate

Date	Estimate #
3/7/2019	EHES

174 Saundersville Road
 Suite 501
 Hendersonville, TN 37075

(615) 761-9040

Name / Address
Hickman County Board of Education Mr. Brad Gilbert 115 Murphree Avenue Centerville, TN 37033

Project

Description	Qty	Rate	Total
Axis M3105-L HD Dome Network Camera, 3 Year Warranty	6	299.00	1,794.00T
Axis P3707-PE HD Network Camera- Includes 4 2MP Cameras that allow multi-position, 3 Year Warranty	1	1,049.00	1,049.00T
Axis P1435 Bullet Camera HD, 3 Year Warranty	8	559.00	4,472.00T
Axis T91B47 Pole Mount-Required for Cafe	1	85.00	85.00T
Axis Camera Station Manager License	15	79.00	1,185.00T
CAT6 Network Drop- Cable Labor to run cable in drop ceiling, terminate to PoE Switch and attach camera to ceiling tile, includes mounting supplies and tools.	15	185.00	2,775.00
Subtotal			\$11,360.00
Sales Tax (0.0%)			\$0.00
Total			\$11,360.00



Estimate

Date	Estimate #
3/7/2019	EHIS

174 Saundersville Road
 Suite 501
 Hendersonville, TN 37075

(615) 761-9040

Name / Address
Hickman County Board of Education Mr. Brad Gilbert 115 Murphree Avenue Centerville, TN 37033

Project

Description	Qty	Rate	Total
Axis M3105-L HD Dome Network Camera, 3 Year Warranty	3	299.00	897.00T
Axis P3707-PE HD Network Camera- Includes 4 2MP Cameras that allow multi-position, 3 Year Warranty	3	1,049.00	3,147.00T
Axis P1435 Bullet Camera HD, 3 Year Warranty	7	559.00	3,913.00T
Axis T91B47 Pole Mount-Required for Front Entrance and Cafe	2	85.00	170.00T
Axis Camera Station Manager License	13	79.00	1,027.00T
CAT6 Network Drop- Cable Labor to run cable in drop ceiling, terminate to PoE Switch and attach camera to ceiling tile, includes mounting supplies and tools.	13	185.00	2,405.00

Subtotal		\$11,559.00
Sales Tax (0.0%)		\$0.00
Total		\$11,559.00



Estimate

Date	Estimate #
3/7/2019	EHMS

174 Saundersville Road
 Suite 501
 Hendersonville, TN 37075

(615) 761-9040

Name / Address
Hickman County Board of Education Mr. Brad Gilbert 115 Murphree Avenue Centerville, TN 37033

Project

Description	Qty	Rate	Total
Axis M3105-L HD Dome Network Camera, 3 Year Warranty	7	299.00	2,093.00T
Axis P3707-PE HD Network Camera- Includes 4 2MP Cameras that allow multi-position, 3 Year Warranty	3	1,049.00	3,147.00T
Axis M5525-E IP Camera HD PTZ Camera, 3 Year Warranty	1	899.95	899.95T
Axis T91L61 Wall Mount-Required for Gym	1	99.00	99.00T
Axis P1435 Bullet Camera HD, 3 Year Warranty	8	559.00	4,472.00T
Axis T91B47 Pole Mount-Required for Front Entrance and Cafe	2	85.00	170.00T
Axis Camera Station Manager License	19	79.00	1,501.00T
CAT6 Network Drop- Cable Labor to run cable in drop ceiling, terminate to PoE Switch and attach camera to ceiling tile, includes mounting supplies and tools.	19	185.00	3,515.00

Subtotal	\$15,896.95
Sales Tax (0.0%)	\$0.00
Total	\$15,896.95



Scope of Work

ATTENTION:
Hickman County School District
Brad Gilbert

FROM:
Bluegrass Computer Systems, LLC
174 Saundersville Road, Suite 501
Hendersonville, TN 37075

SUBJECT:
District Wide Camera Project

Technical Acknowledgements/ Notes /Scope of Work

- 1) BGCSystems acknowledges the goal of HCSS to provide visualizations of persons as specified in 1.1 of the Scope of Work documents of the RFP. In order to provide the best possible accomplishment of this goal, BGCSystems has provided the following.
 - a. In person Walk-Thru completed of all schools by Matthew Barnes, President of BGCSystems, and Philip Draude, Installer and Projector Manager for BGCSystems, on March 4, 2019.
 - b. Attached school maps provide locations for all proposed camera installations. These locations have been established to combine the needs of the schools, as explained in the walk thru, as well as meeting the overall goals of complete visualization. Outdoor cameras are to provide wide shot coverage of the entire parking lot, playground areas, and outdoor common areas.
 - c. All quoted camera provide full HD 1080p.

- 2) The Video Management Solution (VMS) quoted is the Axis Camera Station. BGCSystems believes that this is the best VMS for HCSS for the following reasons:
- a.** Currently, each school is using a variety of different systems, including CCTV and IP from a group of separate vendors with no common user experience or management. Axis Camera Station will provide a simple, easy-to-use user experience across all cameras and schools.
 - b.** East Hickman Elementary is already utilizing 7 models of the Axis Camera Station, which will continue to seamlessly work while additional cameras are being added across the district.
 - c.** Storage is simple as Axis allows attachment of storage from the school district owned SAN (Storage Area Network). This eliminates the cost of both upfront and continued maintenance of the NVR/DVR at each school. Also, additional storage is simple to add as HCSS can simply purchase additional hard drives of various storage capacity. The current SAN will provide storage of 23 hard drives and will allow scalability with new hard drives.
 - d.** The SAN referenced in 2c is already located at the Hickman Co. Central Office and will provide centralized storage of all recordings for the district.
 - e.** Storage capacity will depend on a variety of factors; recording time, recording quality, the use of motion detection or 24/7, utilization of dome/bullet (single vision) vs 4 way panoramic, and total number of cameras utilized. Currently, the server is utilizing 7 cameras with motion detection, one of which being a 4-way camera and has consumed 325GB in the past 7 weeks. A goal of 30-day retention can be reached, under similar circumstances, by providing 29GB per camera. No cloud storage is being utilized and thus no monthly/annual charges will be applied.

- f. HCSS will provide PoE network switching to power all cameras within the school. PoE switches may need to be placed in areas where a network rack is not located in order to assist with cable drop locations. HCSS will have final decision in location, BGCSsystems will make suggestions to aid in this decision.

- 3) The VMS utilized is Axis Camera Station, which is manufactured, supported and maintained to be fully compatible with Axis Cameras. BGCSsystems is a licensed Axis Partner to sell and support all Axis products. There is no expiration date to BGCSsystems' partnership with Axis.

- 4) Onsite walkthrough was completed by BGCSsystems on March 4, 2019 with Mr. Brad Gilbert. BGCSsystems' quote provides a flexible timeframe, allowing the scheduling of various amounts of cameras to be installed at a time. Budget flexibility is offered to HCSS as well, allowing the attached maps to be edited for different camera types.

- 5) Service and Support
 - a. VMS - BGCSsystems will continue to provide service to HCSS's Axis infrastructure under the current BGCS Max agreement. Response time should be provided under 24 hours. Monitoring 24/7 is provided to LEASVRB which notifies BGCS within 5 minutes of any power or network outage. BGCS provides a toll-free number for HCSS to utilize for support.

 - b. Upgrades and options would come only in the form of Axis Camera Station Manager updates. At of the time of this document, upgrading to the newest software is provided at no cost to HCSS. Axis may choose to change this in the future but no announcement has been made at this point.

 - c. HCSS will not incur any costs for additional or ongoing licensing, annual subscription fees or costs, or software upgrades.

 - d. All initial fees are included in the attached proposal.

- e. As referenced in 5a, BGCS will continue to provide HCSS service to all Axis products, Dell PowerEdge Server (Axis Camera Station Server), Dell PowerVault (SAN) and required network infrastructure for camera operation. This service will be provided through the BGCS Max Agreement.

6) Installation

- a. Pre-Planning - please see attached maps for proposed camera locations obtained from 3.4.19 walkthrough.
- b. Sourcing/Product Acquisition - Please reference #3 of this proposal. BGCSystems will acquire all products from a licensed Axis distributor.
- c. Delivery – Upon receipt of a PO from HCSS, BGCSystems will deliver and install cameras and all required materials to the scheduled school/destination. HCSS will not be required to hold any inventory or parts. All items will be installed at the school or housed securely at the BGCSystems Headquarters.
- d. Installation - BGCSystems will provide installation of all camera products, mounts, accessories and software. All camera products will be installed by BGCSystems' employees to a high degree of construction quality, protecting HCSS assets. HCSS is being asked to provide outdoor easement for all outdoor cameras. More specifically, HCSS shall provide a drilled hole through outdoor masonry, allowing BGCSystems to freely pull CAT6 cable from above the indoor drop ceiling through the masonry wall to the outdoor location. In addition, HCSS will be asked to attach camera mounts directly to school buildings when the mount must be attached directly to building exterior. Essentially, BGCSystems will require the assistance of HCSS to drill through or mount to any masonry material, indoor or outdoor. BGCSystems will provide all interior camera mounting as well as all indoor and outdoor CAT6 cable drops. BGCSystems will utilize existing BGCS Max agreement hours to add cameras to the Axis Camera Manager Server, configure

require storage groups on the SAN, and support Active Directory integration.

- e. Schedule - BGCSystems respects the schedule of HCSS and agrees to install at convenient times for HCSS. BGCSystems has worked with HCSS for several years and has become extremely familiar with school staff, administration, requirements, and expectations for being inside a school and around students during school hours. In addition to working closely with HCSS, BGCSystems also works with various other K-12 school districts and is knowledgeable of requirements and expectations for working inside a school district. BGCSystems assumes cleanup responsibility at the end of any job and maintains all tools and equipment nearby during work hours.
- f. Inventory lists will be provided per school instruction and will include asset tagging if requested.

7) Contractor Qualifications

- a. Tennessee State Contractors license with \$500,000 per location limit for Specialty electrical (Category data cable) Please see attached copy of Contractors license.
- b. VMS certification-BGCSystems' Axis Authorized Partner Number is 379351.
- c. Matthew Barnes, President of BGCSystems will serve as the Single Point of Contact.
- d. Both Matthew Barnes and Philip Draude have worked with HCSS for several years personally and are extremely familiar with the district and their overall expectations. Mr. Draude has spent several years running data cable and providing various multi-media services to K-12 schools, including HCSS. The installation of existing Axis infrastructure was installed and designed by BGCSystems. Mr. Barnes has likewise spent years working with K-12 schools districts for various IT needs, including HCSS, and as the owner of BGCSystems, has full control of the quality and efficiency of the project.



REPUBLIC OF TENNESSEE
DEPARTMENT OF
COMMERCE AND INSURANCE



BLUEGRASS COMPUTER SYSTEMS, LLC

12903

ID NUMBER: 69993
LIC STATUS: ACTIVE
EXPIRATION DATE: June 30, 2018

BOARD FOR LICENSING CONTRACTORS
CONTRACTOR

THIS IS TO CERTIFY THAT ALL REQUIREMENTS
OF THE STATE OF TENNESSEE HAVE BEEN MET

Attn: MATTHEW BARNES
BLUEGRASS COMPUTER SYSTEMS, LLC
174 SAUNDERSVILLE RD
SUITE 501
HENDERSONVILLE, TN 37075

CI 09930256
323014

State of Tennessee

BOARD FOR LICENSING CONTRACTORS

CONTRACTOR

BLUEGRASS COMPUTER SYSTEMS, LLC







This is to certify that all requirements of the State of Tennessee have been met.

ID NUMBER: 69993
LIC STATUS: ACTIVE
EXPIRATION DATE: June 30, 2018
AGLM \$500,000.00; S-Low Voltage









IN-1313
DEPARTMENT OF
COMMERCE AND INSURANCE

Centerville Intermediate

-  4-way
-  PTZ
-  Dome
-  Indoor-Bullet
-  Outdoor-Bullet
-  Rack



Hickman County Middle School

-  4-way
-  PTZ
-  Dome
-  Indoor-Bullet
-  Outdoor-Bullet
-  Rack

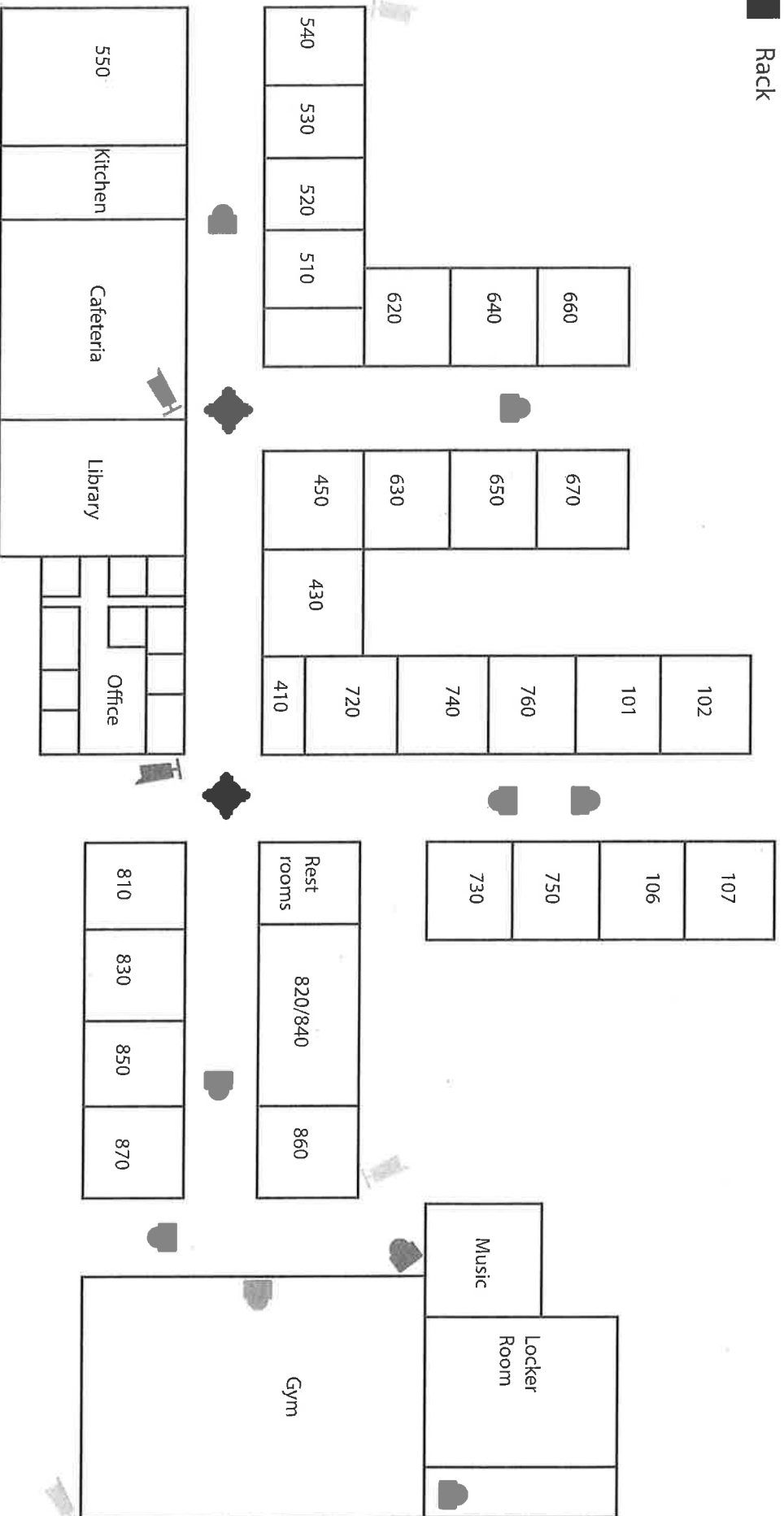

East Hickman Elementary

-  4-way
-  PTZ
-  Dome
-  Indoor-Bullet
-  Outdoor-Bullet
-  Rack

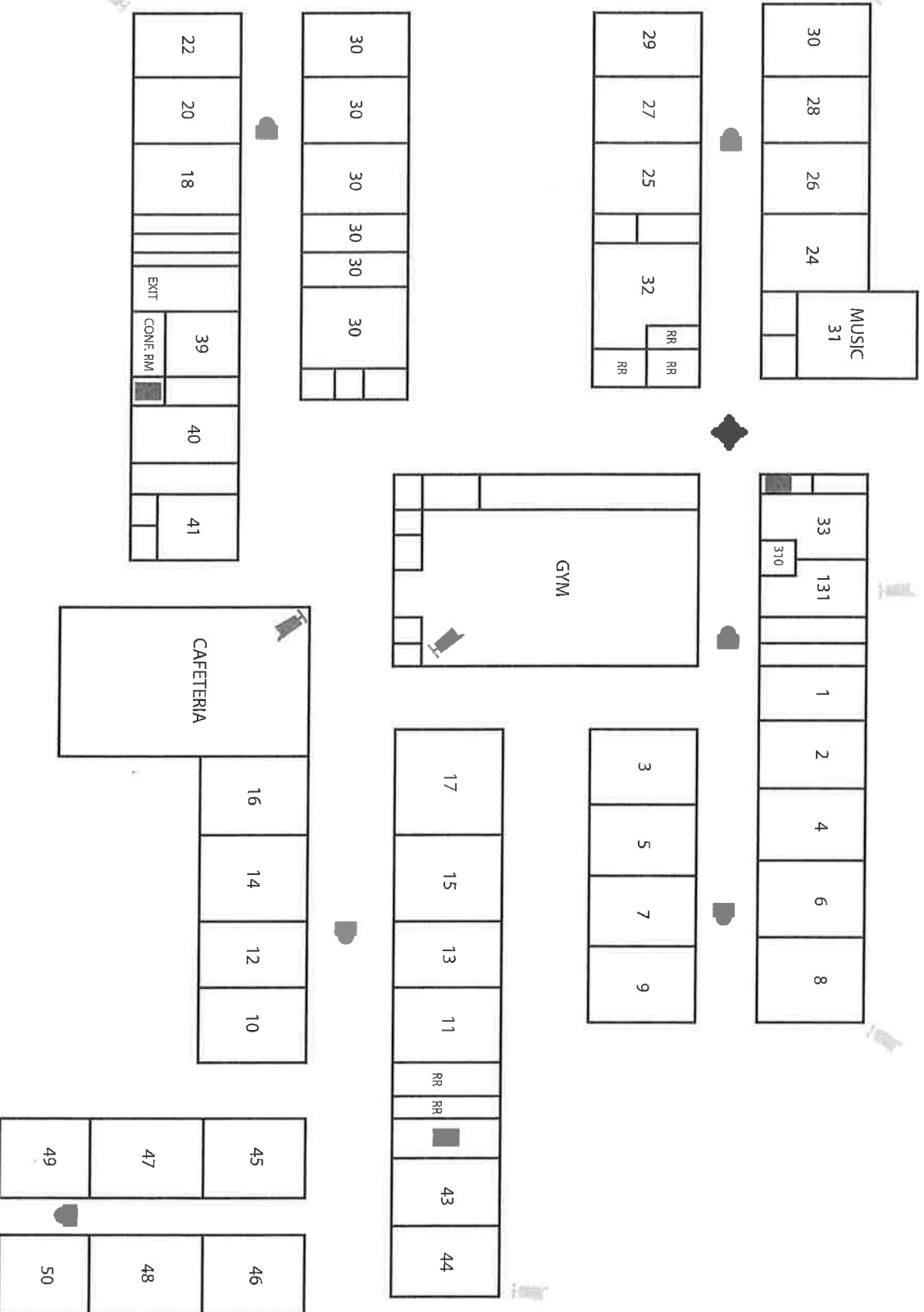





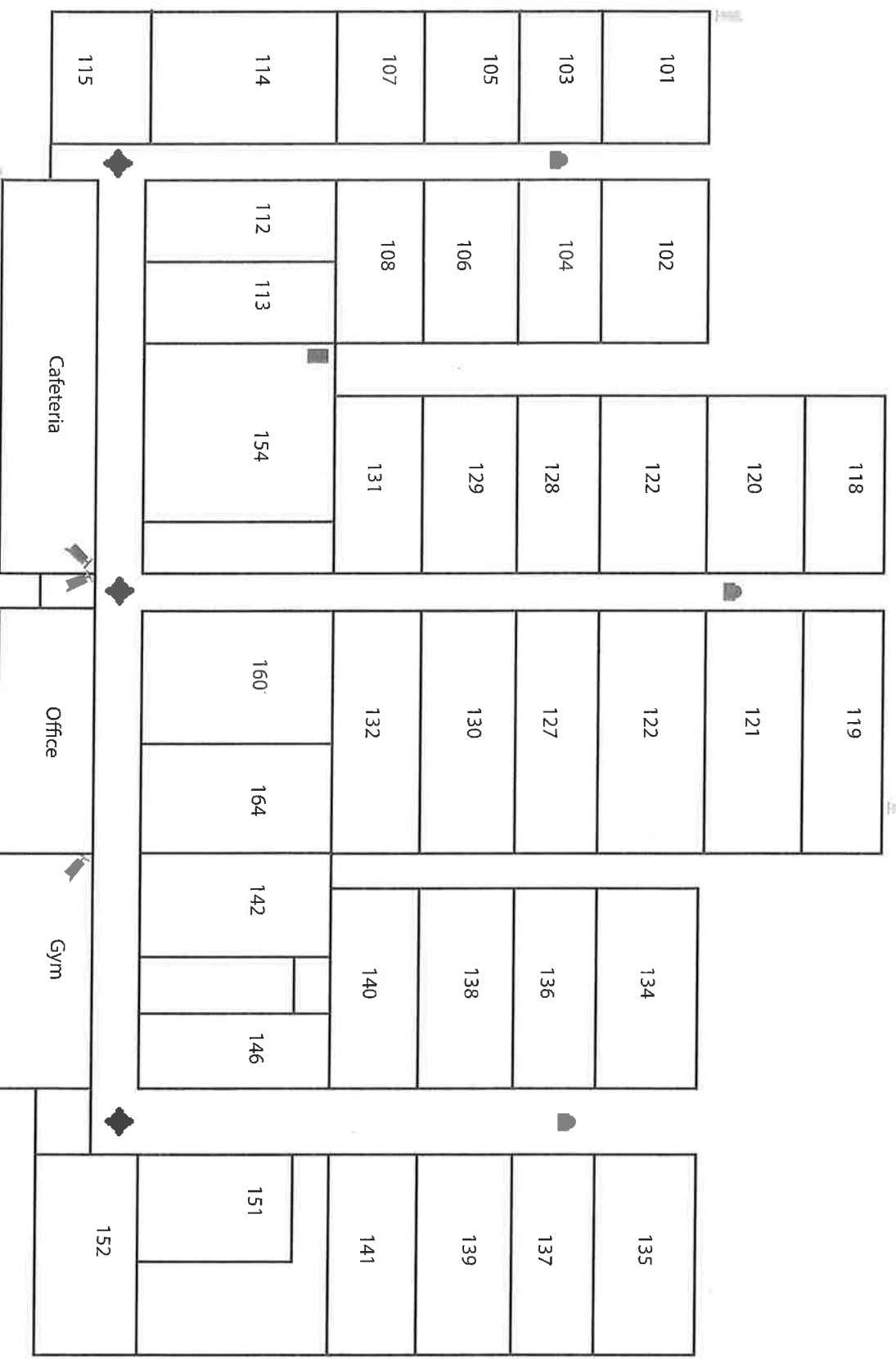

East Hickman Intermediate

-  4-way
-  PTZ
-  Dome
-  Indoor-Bullet
-  Outdoor-Bullet
-  Rack



East Hickman Middle

-  4-way
-  PTZ
-  Dome
-  Indoor-Bullet
-  Outdoor-Bullet
-  Rack

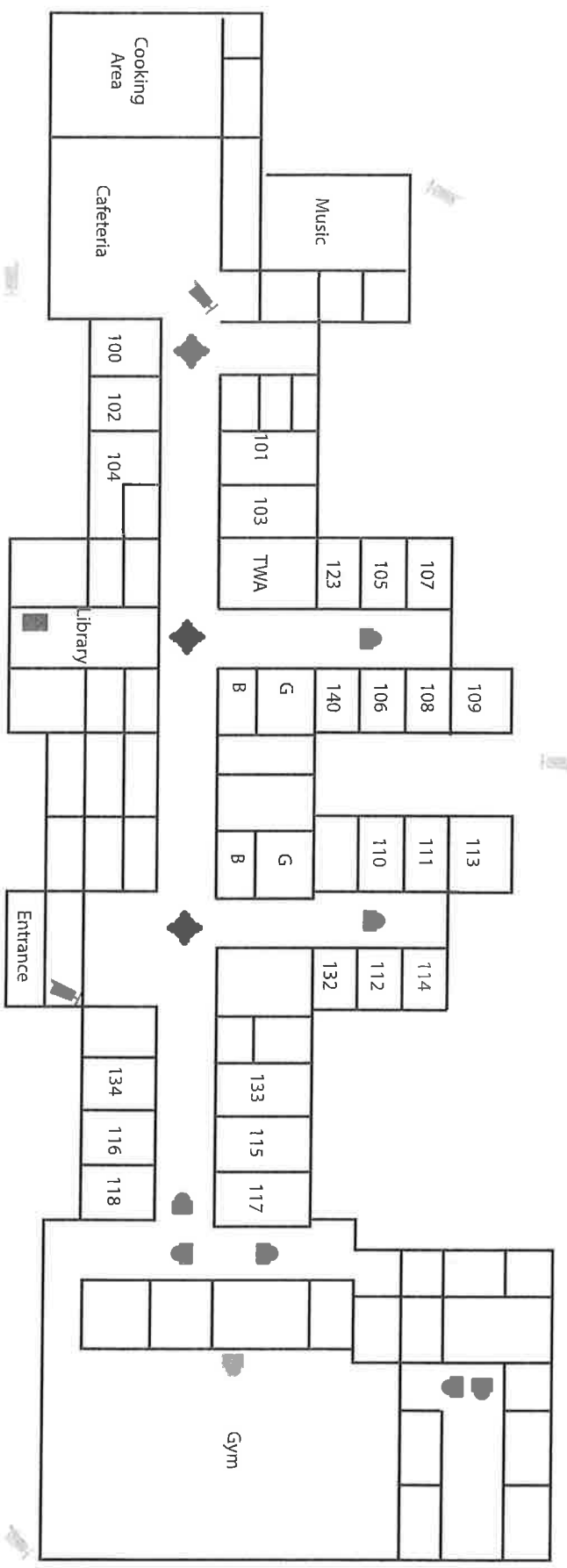

AXIS M3105-L Network Camera

Discreet HDTV 1080p video surveillance with built-in IR illumination

AXIS M3105-L is an affordable, discreet fixed mini dome with a flat-faced design that suppresses reflections. Using WDR technology and IR illumination, it provides compact HDTV surveillance even in challenging light conditions or total darkness. The smart design allows for easy repainting, or using the optional black accessory casing to blend the camera into its environment. Axis Zipstream technology reduces bandwidth and storage requirements. A variety of accessories are available for flexible and easy installation.

- > **Built-in IR illumination**
- > **HDTV 1080p video**
- > **WDR – Forensic Capture**
- > **Axis Zipstream technology**
- > **Smart design for easy, flexible installation**



AXIS M3105-L Network Camera

Camera		Day/night mode, overlay text, IR illumination, WDR mode
Image sensor	1/2.8" progressive scan RGB CMOS	Data streaming Event data
Lens	M12 mount, Fixed iris, Fixed focus 2.8 mm, F2.0 Horizontal field of view: 115° Vertical field of view: 64°	Built-in installation aids Pixel counter
Day and night	Automatically removable infrared-cut filter	General
Minimum illumination	Color: 0.2 lux at 50 IRE, F2.0 B/W: 0.04 lux at 50 IRE, F2.0 0 lux with IR illumination on	Casing IP42 water and dust resistant (to comply with IP42, follow instructions in Installation Guide), ASA polymer casing Encapsulated electronics, Captive screws (Torx 10) Color: White NCS S 1002-B For repainting instructions and impact on warranty, contact your Axis partner
Shutter time	1/66500 s to 2 s	Sustainability PVC free
Camera angle adjustment	Pan: ±180° Tilt: 0° to 60° (0° = lens directed at a right angle to camera base) Rotation: ±95° Can be directed in any direction and see the wall/ceiling	Memory 512 MB RAM, 256 MB Flash
Video		Power Power over Ethernet (PoE) IEEE 802.3af/802.3at Type 1 Class 2 Typical: 4.2 W, Max.: 6.2 W
Video compression	H.264 (MPEG-4 Part 10/AVC) Baseline, Main and High Profiles Motion JPEG	Connectors RJ45 10BASE-T/100BASE-TX PoE
Resolution	1920x1080 to 176x120	IR illumination Power-efficient, long-life 850 nm IR LED. Range of reach 15 m (50 ft) or more depending on the scene
Frame rate	Up to 25/30 fps with power line frequency 50/60 Hz	Storage Support for microSD/microSDHC/microSDXC card Support for SD card encryption Support for recording to network-attached storage (NAS) For SD card and NAS recommendations see www.axis.com
Video streaming	Multiple, individually configurable streams in H.264 and Motion JPEG Axis Zipstream technology in H.264 Controllable frame rate and bandwidth VBR/MBR H.264	Operating conditions 0 °C to 50 °C (32 °F to 122 °F) Humidity 10–85% RH (non-condensing)
Multi-view streaming	Up to 2 individually cropped out view areas in full frame rate	Storage conditions -40 °C to 65 °C (-40 °F to 149 °F)
Pan/Tilt/Zoom	Digital PTZ	Approvals EMC EN 55022 Class B, EN 55024, IEC 62471, EN 61000-6-1, EN 61000-6-2, FCC Part 15 Subpart B Class B, ICES-003 Class B, VCCI Class B, RCM AS/NZS CISPR 22 Class B, KCC KN32 Class B, KN35 Environment IEC 60068-2-1, IEC 60068-2-2, IEC 60068-2-78, IEC 60068-2-14, IEC 60068-2-6, IEC 60068-2-27, IEC/EN 60529 IP42, IEC 60721-3-4 Class 3M3 Safety IEC/EN/UL 62368-1 Network NIST SP500-267
Image settings	Compression, Color, Brightness, Sharpness, Contrast, Local contrast, White balance, Exposure control, WDR – Forensic Capture: up to 115 dB depending on scene. Rotation: 0°, 90°, 180°, 270° including Corridor Format, Text and image overlay, Privacy masks, Mirroring of images	Dimensions Height: 85 mm (3.3 in) ø 100 mm (3.9 in)
Network		Weight 360 g (0.78 lb)
Security	Password protection, IP address filtering, HTTPS ^a encryption, IEEE 802.1X ^a network access control, Digest authentication, User access log, Centralized Certificate Management, brute force delay protection IPv4, IPv6 USGv6, HTTP, HTTPS ^a , SSL/TLS ^a , QoS Layer 3 DiffServ, FTP, SFTP, CIFS/SMB, SMTP, Bonjour, UPnP ^{IM} , SNMP v1/v2c/v3 (MIB-II), DNS, DynDNS, NTP, RTSP, RTP, SRTP, TCP, UDP, IGMP, RTCP, ICMP, DHCP, ARP, SOCKS, SSH, LLDP	Included accessories Installation Guide, Windows decoder 1-user license, Torx® L-key
System integration		Optional accessories AXIS T94B02D Pendant kit AXIS T94B01P Conduit Back Box AXIS T94B02M J-Box/Gang Box Plate AXIS M31-L Casing, Black Axis Mounts AXIS Surveillance microSDXC™ Card For more accessories, see www.axis.com
Application Programming Interface	Open API for software integration, including VAPIX [®] and AXIS Camera Application Platform; specifications at www.axis.com AXIS Video Hosting System (AVHS) with One-Click Connection ONVIF [®] Profile G, ONVIF [®] Profile S, and ONVIF [®] Profile T, specification at onvif.org	Video management software AXIS Companion, AXIS Camera Station, Video management software from Axis' Application Development Partners available on www.axis.com/vms
Analytics	Included AXIS Video Motion Detection, active tampering alarm Supported AXIS Digital Autotracking, AXIS Fence Guard, AXIS Motion Guard, AXIS Loitering Guard, AXIS People Counter, AXIS Queue Monitor, AXIS Occupancy Estimator, AXIS Direction Detector, AXIS Tailgating Detector, AXIS Random Selector Support for AXIS Camera Application Platform enabling installation of third-party applications, see www.axis.com/acap	Languages English, German, French, Spanish, Italian, Russian, Simplified Chinese, Japanese, Korean, Portuguese, Traditional Chinese
Event triggers	Analytics, Edge storage events, Virtual inputs through API	Warranty Axis 3-year warranty and AXIS Extended Warranty option, see www.axis.com/warranty
Event actions	File upload: FTP, SFTP, HTTP, HTTPS, network share, email Notification: email, HTTP, HTTPS, TCP, SNMP trap Video recording to edge storage Send video clip Pre- and post-alarm video buffering Overlay text	a. This product includes software developed by the OpenSSL Project for use in the OpenSSL Toolkit. (www.openssl.org), and cryptographic software written by Eric Young (eay@cryptsoft.com).
		Environmental responsibility: www.axis.com/environmental-responsibility

AXIS P3707-PE Network Camera

Flexible, 360° multisensor camera

AXIS P3707-PE Network Camera is an 8-megapixel multisensor fixed camera with four varifocal lenses that enable overview and detailed surveillance. With one IP address, one network cable, PoE support, IP66 and IP67 ratings, the four-camera-in-one unit provides a flexible, cost-effective solution for multidirectional surveillance in large indoor and outdoor areas, and at the intersection of hallways and roads. Each camera head can be moved along a circular track. The tilt angle and the field of view of each lens are adjustable, and each camera head can rotate to support Axis' Corridor Format. The specially designed clear cover, with no sharp edges, ensures undistorted views in all directions.

- > **8 MP, 360° multisensor camera, one IP address**
- > **Flexible positioning of four varifocal camera heads**
- > **1080p videos at 12.5/15 fps; 720p videos at 25/30 fps; quad view stream**
- > **Axis' Zipstream technology**

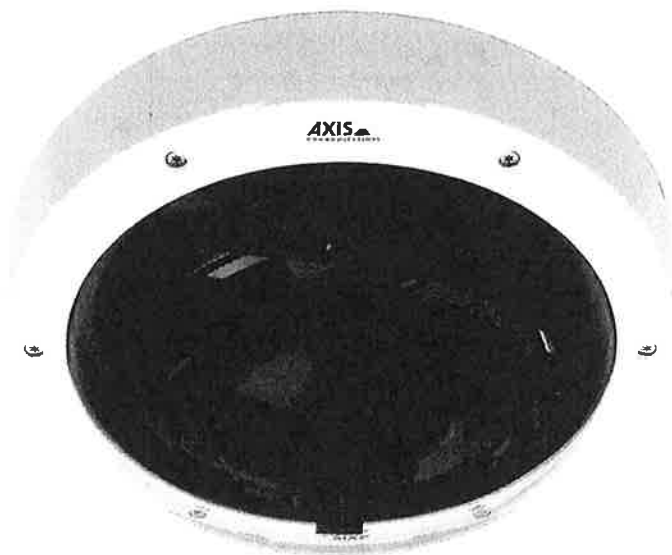

AXIS P3707-PE Network Camera

Camera		File upload: FTP, SFTP, HTTP, HTTPS network share and email Notification: email, HTTP, HTTPS and TCP
Image sensor	4 x 1/2.8" progressive scan RGB CMOS	
Lens	Varifocal, 2.8–6 mm, F2.0 4x1080p capture mode: Horizontal field of view: 108°–54° Vertical field of view: 57°–30° 4xHDTV 720p capture mode: Horizontal field of view: 67°–36° Vertical field of view: 37°–20° Adjustable focus and zoom, fixed iris	
Minimum illumination	Color: 0.3 lux, F2.0	
Shutter time	720p: 1/28000 s to 2 s 1080p: 1/22500 s to 2 s	
Video		
Video compression	H.264 (MPEG-4 Part 10/AVC) Baseline, Main and High Profiles Motion JPEG	
Resolution	4 x 1920x1080 (1080p) to 160x90 Quad view 1920x1440 to 480x270	
Frame rate	Up to 25/30 fps (50/60 Hz) with 720p capture mode Up to 12.5/15 fps (50/60 Hz) with 1080p capture mode	
Video streaming	Multiple, individually configurable streams in H.264 and Motion JPEG Axis Zipstream technology in H.264 Controllable frame rate and bandwidth VBR/MBR H.264	
Image settings	Color, brightness, sharpness, contrast, white balance, exposure control, exposure zone, fine tuning of behavior at low light, rotation: 0°, 90°, 180°, 270° including Corridor Format, text and image overlay, privacy mask, Local contrast	
Camera angle adjustment	Pan ±90° Tilt 28°–92° Rotate ±90°	
Network		
IP address	One IP address for all channels	
Security	Password protection, IP address filtering, HTTPS ^a encryption, IEEE 802.1X ^a network access control, digest authentication, user access log, centralized certificate management	
Supported protocols	IPv4/IPv6, HTTP, HTTPS ^a , SSL/TLS ^a , QoS Layer 3 DiffServ, FTP, CIFS/SMB, SMTP, Bonjour, UPnP TM , SNMP v1/v2c/v3 (MIB-II), DNS, DynDNS, NTP, RTSP, RTP, SFTP, TCP, UDP, IGMP, RTCP, ICMP, DHCP, ARP, SOCKS, SSH	
System integration		
Application Programming Interface	Open API for software integration, including VAPIX [®] and AXIS Camera Application Platform; specifications at www.axis.com AXIS Video Hosting System (AVHS) with One-Click Connection ONVIF [®] Profile S and ONVIF [®] Profile G, specification at www.onvif.org	
Analytics	Included AXIS Video Motion Detection, active tampering alarm Support for AXIS Camera Application Platform enabling installation of third-party applications, see www.axis.com/acap	
Event triggers	Analytics, edge storage events	
Event actions	Overlay text, pre- and post-alarm video buffering, video recording to edge storage, SNMP trap	
Data streaming	Event data	
Built-in installation aids	Pixel counter	
General		
Casing	IP66-, IP67-, NEMA 4X- and IK09-rated Die-casted aluminum, polycarbonate dome	
Sustainability	PVC free	
Memory	1 GB RAM, 256 MB Flash	
Power	Power over Ethernet (PoE) IEEE 802.3af/802.3at Type 1 Class 2 Typical 4.8 W, max 5.5 W	
Connectors	Shielded RJ45 10BASE-T/100BASE-TX PoE	
Storage	Support for microSD/microSDHC/microSDXC card Support for SD card encryption Support for recording to network-attached storage (NAS) For SD card and NAS recommendations see www.axis.com	
Operating conditions	-30 °C to 60 °C (-22 °F to 140 °F) Humidity 10–100% RH (condensing)	
Storage conditions	-40 °C to 65 °C (-40 °F to 149 °F)	
Approvals	EMC EN 55022 Class B, EN 61000-3-2, EN 61000-3-3, EN 55024, EN 61000-6-1, EN 61000-6-2, FCC Part 15 Subpart B Class A+B, ICES-003 Class B, VCCI Class B, RCM AS/NZS CISPR 22 Class B, KCC KN32 Class B, KN35, EN 50121-4, IEC 62236-4 Safety IEC/EN/UL 60950-1, IEC/EN/UL 60950-2 Environment IEC 60068-2-1, IEC 60068-2-2, IEC 60068-2-6, IEC 60068-2-14, IEC 60068-2-27, IEC/EN 62262 IK09, IEC/EN 60529 IP66/IP67, NEMA 250 Type 4X	
Dimensions	Diameter: ø 270 mm (10 5/8 in), Height: 91.5 mm (3 5/8 in)	
Weight	2.2 kg (4.9 lb)	
Included accessories	RJ45 mounting tool, Installation Guide, Windows decoder 1-user license	
Optional accessories	AXIS T8415 Wireless Installation Tool, AXIS T94M02D Pendant Kit including weather shield, AXIS P3707-PE Clear Dome Kit, AXIS T91 Mounting Accessories, AXIS T8120 15 W Midspan 1-port For more accessories, see www.axis.com	
Video management software	AXIS Camera Companion, AXIS Camera Station, Video management software from Axis' Application Development Partners available on www.axis.com/techsup/software	
Languages	English, German, French, Spanish, Italian, Russian, Simplified Chinese, Japanese, Korean, Portuguese, Traditional Chinese	
Warranty	Axis 3-year warranty and AXIS Extended Warranty option, see www.axis.com/warranty	

a. This product includes software developed by the OpenSSL Project for use in the OpenSSL Toolkit. (www.openssl.org), and cryptographic software written by Eric Young (ey@cryptsoft.com).

Environmental responsibility:

www.axis.com/environmental-responsibility

AXIS M5525-E PTZ Network Camera

Indoor and outdoor PTZ with 10x zoom

AXIS M5525-E PTZ Network Camera is a compact pan-tilt-zoom camera with HDTV 1080p resolution, 10x optical zoom, and autofocus, enabling great video quality in both overview and detail. Day/night functionality and WDR – Forensic Capture ensures maintained image quality in low or mixed light, and scene profiles are included for automatic optimization. AXIS M5525-E is compatible with any Axis PTZ mount for outdoor installation, but can also be surface-mounted indoors. Protected against dust, rain, snow, and corrosion, the camera operates in temperatures from -20 °C to 50 °C (-4 °F to 122 °F). The microSD card slot enables local video storage.

- > **HDTV 1080p with 10x optical zoom**
- > **Continuous 360° for uninterrupted pan**
- > **WDR — Forensic Capture**
- > **Axis Zipstream technology**
- > **I/O ports and two-way audio**

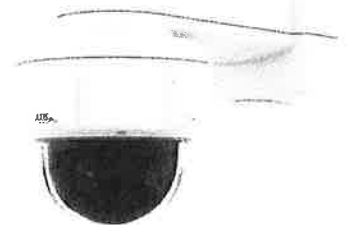
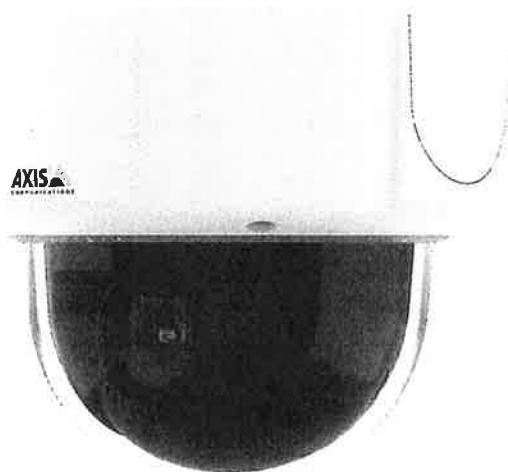

AXIS M5525-E PTZ Network Camera

Camera		Time: recurrence, use schedule
Image sensor	1/2.8" progressive scan CMOS	
Lens	4.7–47 mm, F1.6–3.0 Horizontal field of view: 61.8°–6.7° Vertical field of view: 37.2°–3.8° Autofocus, auto-iris	
Day and night	Automatically removable infrared-cut filter	
Minimum illumination	Color: 0.45 lux at 30 IRE F1.6 B/W: 0.01 lux at 30 IRE F1.6 Color: 0.55 lux at 50 IRE F1.6 B/W: 0.01 lux at 50 IRE F1.6	
Shutter time	1/66500 s to 2 s	
Pan/Tilt/Zoom	Pan: 360° endless, 1.8°–150°/s Tilt: 90°, 1.8°–150°/s 10x optical zoom, 12x digital zoom, total 120x zoom Nadir flip, 100 preset positions, limited guard tour, control queue, on-screen directional indicator	
Video		
Video compression	H.264 (MPEG-4 Part 10/AVC) Baseline, Main and High Profiles Motion JPEG	
Resolution	1920x1080 to 320x180	
Frame rate	Up to 25/30 fps with power line frequency 50/60 Hz	
Video streaming	Multiple, individually configurable streams in H.264 and Motion JPEG Axis Zipstream technology in H.264 Controllable frame rate and bandwidth VBR/MBR H.264	
Image settings	Saturation, brightness, sharpness, WDR – forensic capture, white balance, exposure mode, exposure zones, compression, text and image overlay, 20 individual 3D privacy masks, contrast, scene profiles, image freeze on PTZ, local contrast, max shutter, max gain, noise/motion priority, aperture lock, exposure level, rotation: 0°, 180°	
Audio		
Audio streaming	Two-way, full duplex	
Audio compression	AAC-LC 8/16/32 kHz, G.711 PCM 8 kHz, G.726 ADPCM 8 kHz Configurable bit rate	
Audio input/output	External microphone input or line input, line output	
Network		
Security	Password protection, IP address filtering, HTTPS ^a encryption, IEEE 802.1X ^a network access control, Digest authentication, User access log, Centralized Certificate Management, Brute force delay protection	
Supported protocols	IPv4, IPv6, USGv6, HTTP, HTTPS ^a , SSL/TLS ^a , QoS Layer 3 DiffServ, FTP, SFTP, CIFS/SMB, SMTP, Bonjour, UPnP TM , SNMP v1/v2c/v3(MIB-II), DNS, DynDNS, NTP, RTSP, RTP, TCP, UDP, IGMP, RTP, ICMP, DHCP, ARP, SOCKS, SSH, LLDP	
System integration		
Application Programming Interface	Open API for software integration, including VAPIX [®] and AXIS Camera Application Platform; specifications at axis.com AXIS Guardian with One-Click Connection ONVIF [®] Profile S and ONVIF [®] Profile G, specification at onvif.org	
Analytics	Included AXIS Video Motion Detection, audio detection, advanced gatekeeper Supported AXIS Cross Line Detection, AXIS Guard Suite including AXIS Fence Guard, AXIS Motion Guard and AXIS Loitering Guard Support for AXIS Camera Application Platform enabling installation of third-party applications, see axis.com/acap	
Event triggers	Analytics, edge storage events Detectors: day/night mode, live stream accessed, audio detection Hardware: network, temperature Input Signal: digital input port, manual trigger, virtual inputs PTZ: error, moving, preset reached, ready Storage: disruption, recording System: system ready	
Event actions	Record video: SD card and network share Upload of images or video clips: FTP, SFTP, HTTP, HTTPS, network share, and email Pre- and post-alarm video or image buffering for recording or upload Notification: email, HTTP, HTTPS, TCP, and SNMP trap PTZ: PTZ preset, start/stop guard tour Overlay text, play audio clip, external output activation, WDR mode	
Data streaming	Event data	
Built-in installation aids	Pixel counter	
General		
Casing	IP66-, NEMA 4X- and IK09-rated Repaintable plastic casing, polycarbonate (PC) dome	
Sustainability	PVC free	
Memory	512 MB RAM, 256 MB Flash	
Power	Power over Ethernet (PoE) IEEE 802.3af/802.3at Type 1 Class 3 Typical 6.6 W, max 12.95 W 20–28 V DC, typical 6.3 W, max 13 W (PoE midspan and power supply not included)	
Connectors	RJ45 10BASE-T/100BASE-TX PoE DC input terminal block I/O: 6-pin terminal block with push-in spring connection for four configurable inputs/outputs Audio: mic/line in, line out terminal block with push-in spring connection	
Storage	Support for microSD/SDHC/SDXC card (not included) Support for SD card encryption Support for recording to network-attached storage (NAS) For SD card and NAS recommendations see axis.com	
Operating conditions	–20 °C to 50 °C (–4 °F to 122 °F) Humidity 15–100% RH (condensing)	
Storage conditions	–40 °C to 65 °C (–40 °F to 149 °F)	
Approvals	EMC EN 55032 Class A, EN 61000-3-2, EN 61000-3-3, EN 55024, EN 61000-6-1, EN 61000-6-2, FCC Part 15 Subpart B Class A, ICES-003 Class A, VCCI Class A, RCM AS/NZS CISPR 32 Class A, KC KN32 Class A, KN35 Safety IEC/EN/UL 62368-1, IEC/EN/UL 60950-22, IS 13252 Environment IEC 60068-2-27, IEC 60068-2-6, IEC/EN 60529 IP66, IEC/EN 62262 IK09 Network NIST SP500-267	
Dimensions	Height: 132 mm (5.2 in), ø 165 mm (6.5 in)	
Weight	1.1 kg (2.4 lb) Recessed mount (plenum rated): 1.0 kg (2.2 lb)	
Included accessories	Conduit adapter 3/4", smoked dome, adapter bayonette Installation Guide, Windows [®] decoder 1-user license	
Optional accessories	AXIS T91 Mounting Accessories, AXIS T94P01L Recessed Mount Kit	
Video management software	AXIS Companion, AXIS Camera Station, video management software from Axis' Application Development Partners available at axis.com/vms	
Languages	English, German, French, Spanish, Italian, Russian, Simplified Chinese, Japanese, Korean, Portuguese, Traditional Chinese	
Warranty	Axis 3-year warranty and AXIS Extended Warranty option, see axis.com/warranty	

a. This product includes software developed by the OpenSSL Project for use in the OpenSSL Toolkit. (www.openssl.org), and cryptographic software written by Eric Young (ey@cryptsoft.com).

Environmental responsibility:

www.axis.com/environmental-responsibility

AXIS P1435-LE Network Camera

Compact and fully-featured HDTV for any light condition

With Lightfinder and WDR – Forensic Capture, the AXIS P1435-LE bullet camera provides excellent image quality in HDTV 1080p resolution. At low light, Axis' OptimizedIR automatically adapts the exposure of the camera resulting in high-quality and low-noise video. The camera features corridor format, pixel counter, remote zoom and focus, as well as P-Iris control – ensuring optimal depth of field, resolution, image contrast and clarity. The I/O port can be used for notification to an alarm panel or control of a relay. Axis Zipstream technology reduces bandwidth and storage requirements. The outdoor-ready camera comes with either a wide or a tele lens.

- > Slim, bullet camera
- > Built-in IR LEDs with OptimizedIR
- > Two lens alternatives
- > HDTV 1080p at up to 50/60 fps
- > Axis Zipstream

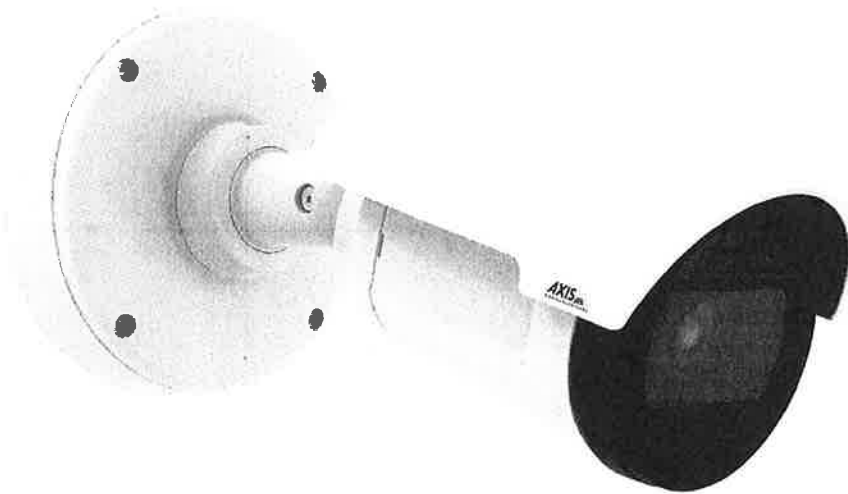

AXIS P1435-LE Network Camera

Camera		System: System Ready Time: Use Schedule, Recurrences
Image sensor	Progressive scan CMOS 1/2.8"	
Lens	3–10.5 mm, F1.4: Horizontal field of view: 95°–35° Vertical field of view: 51°–20° 10–22 mm, F1.85: Horizontal field of view: 34.5°–18° Vertical field of view: 20°–11° Varifocal, Remote focus and zoom, P-Iris control, IR corrected	Event actions File upload: FTP, SFTP, HTTP, HTTPS network share and email Notification: email, HTTP, HTTPS and TCP and SNMP trap External output activation Video recording to edge storage Pre- and post-alarm video buffering WDR mode PTZ control, Overlay text IR illumination
Day and night	Automatically removable infrared-cut filter	
Minimum illumination	3–10.5 mm, at 50 IRE F1.4: Color: 0.12 lux at 30 fps Color: 0.24 lux at 60 fps B/W: 0.01 lux at 30 fps B/W: 0.02 lux at 60 fps 10–22 mm, at 50 IRE F1.85: Color: 0.16 lux at 30 fps Color: 0.32 lux at 60 fps B/W: 0.02 lux at 30 fps B/W: 0.03 lux at 60 fps 0 lux with IR illumination on	Built-in installation aids Pixel counter, Remote zoom (3–10.5 mm 3.5x optical, 10–22 mm 2x optical), Remote focus
Shutter time	1/66500 to 2 s	Data streaming Event data
Video		General
Video compression	H.264 High, Main and Baseline profiles (MPEG-4 Part 10/AVC) Motion JPEG	Casing IP66, IP67- and NEMA 4X-rated casing (polyester polycarbonate blend)
Resolution	HDTV 1080p 25/30 fps (WDR): 1920x1080 to 160x90 HDTV 1080p 50/60 fps (no WDR): 1920x1080 to 160x90 Meets relevant parts of SMPTE 274M (HDTV 1080p)	Sustainability PVC free
Frame rate	Up to 50/60 fps (50/60 Hz, no WDR) in all resolutions	Memory 512 MB RAM, 256 MB Flash
Video streaming	Multiple, individually configurable streams in H.264 and Motion JPEG Axis Zipstream technology in H.264 Controllable frame rate and bandwidth VBR/MBR H.264	Power Power over Ethernet IEEE 802.3af/802.3at Type 1 Class 3 Typical: 4.6 W, max 11 W
Multi-view streaming	Up to 8 individually cropped out view areas	Connectors RJ45 10BASE-T/100BASE-TX PoE I/O: 4-pin terminal block for 1 alarm input and 1 output
Image settings	Manual shutter time, Compression, Color, Brightness, Sharpness, White balance, Exposure control, Exposure zones, Fine tuning of behavior at low light, Text and image overlay, Privacy masks, IR illumination Wide Dynamic Range – Forensic Capture: Up to 120 dB depending on scene, Mirroring of images Rotation: 0°, 90°, 180°, 270°, including Corridor Format	IR illumination Optimized/IR, highly efficient LEDs with adjustable intensity and angle of illumination. 3–10.5 mm: Range up to 30 m (98 ft) 10–22 mm: Range up to 50 m (164 ft)
Pan/Tilt/Zoom	Digital PTZ	Storage Support for microSD/microSDHC/microSDXC card Support for SD card encryption Support for recording to network-attached storage (NAS) For SD card and NAS recommendations see www.axis.com
Network		Operating conditions -30 °C to 55 °C (-22 °F to 131 °F) -30 °C to 60 °C (-22 °F to 140 °F) when IR LEDs are off Humidity 10–100% RH (condensing)
Security	Password protection, IP address filtering, HTTPS ^a encryption, IEEE 802.1X ^a network access control, Digest authentication, User access log, brute force delay protection	Storage conditions -40 °C to 65 °C (-40 °F to 149 °F)
Supported protocols	IPv4, IPv6 USGv6, HTTP, HTTPS ^a , SSL/TLS ^a , QoS Layer 3 DiffServ, FTP, CIFS/SMB, SMTP, Bonjour, UPnP TM , SNMP v1/v2c/v3 (MIB-II), DNS, DynDNS, NTP, RTSP, RTP, SRTP, SFTP, TCP, UDP, IGMP, RTCP, ICMP, DHCP, ARP, SOCKS, SSH LLDP	Approvals EN 55022 Class B, EN 61000-6-1, EN 61000-6-2, EN 50121-4, IEC 62236-4, EN 55024, FCC Part 15 Subpart B Class B, ICES-003 Class B, VCCI Class B, RCM AS/NZS CISPR 22 Class B, KCC KN22 Class B, KN24, IEC/EN/UL 60950-1, IEC/EN/UL 60950-22, EN 62471, IEC/EN 60529 IP66/IP67, IEC/EN 62262 IK08, NEMA 250 type 4X, IEC 60068-2-1, IEC 60068-2-2, IEC 60068-2-6, IEC 60068-2-27 Network NIST SP500-267
System integration		Weight With weather shield: 800 g (1.75 lb)
Application Programming Interface	Open API for software integration, including VAPIX [®] and AXIS Camera Application Platform; specifications at axis.com ONVIF [®] Profile G, ONVIF [®] Profile S and ONVIF [®] Profile T, specification at onvif.org	Dimensions Ø132 x 260 mm (Ø5 3/16 x 10 1/4 in)
Analytics	Included AXIS Video Motion Detection Supported AXIS Digital Autotracking, AXIS Perimeter Defender, AXIS Cross Line Detection Support for AXIS Camera Application Platform enabling installation of third-party applications, see axis.com/acap	Included accessories Mounting bracket, Drill template, Installation Guide, Windows decoder 1-user license AXIS Weather Shield L
Event triggers	Analytics Detectors: Day/Night Mode, Live Stream Accessed, Tampering Hardware: Network, Temperature Input Signal: Manual Trigger, Virtual Inputs Storage: Disruption, Recording	Optional accessories AXIS T94F01M J-Box/Gang Box Plate AXIS T91A47 Pole Mount AXIS T94P01B Corner Bracket AXIS T94F01P Conduit Back Box AXIS Weather Shield K Axis PoE Midspans For more accessories, see www.axis.com
		Video management software AXIS Companion, AXIS Camera Station, Video management software from Axis' Application Development Partners available on www.axis.com/vms
		Languages English, German, French, Spanish, Italian, Russian, Simplified Chinese, Japanese, Korean, Portuguese, Traditional Chinese
		Warranty Axis 3-year warranty and AXIS Extended Warranty option, see www.axis.com/warranty

a. *This product includes software developed by the OpenSSL Project for use in the OpenSSL Toolkit (<http://www.openssl.org/>), and cryptographic software written by Eric Young (ey@cryptsoft.com).*

Hickman County Board of Education

	Descriptor Term:	Descriptor Code:	Issued Date:
	Use of Personal Communication Devices and Electronic Devices	6.312	04/01/19
		Rescinds:	Issued:
		6.312	07/07/14

1 Students in grades K-12 may possess personal communication devices and personal electronic devices
2 while on school property. Such devices include, but are not limited to, wearable technology such as
3 eye glasses, rings, or watches that have the capability to record, live stream, or interact with wireless
4 technology; cell phones; laptops; pagers; tablets; and mp3 players.

5 For students in grades K-5, the device must be in the off mode and must be kept in a backpack, pocket,
6 purse, or similar personal carry-all and may not be used during school hours without specific
7 permission from the principal/designee.

8 For students in grades 6-12, principals/designees will determine appropriate times when such devices
9 may be used.

10 At the direction of the teacher, and with the approval of the administration, students are encouraged to
11 bring personal electronic devices to school that support learning. Use of devices must be aligned with
12 the instruction taking place in a classroom.

13 At no time shall a student operate any device with video or picture taking capabilities in a locker room,
14 classroom, bathroom, or other location where such operation may violate the privacy rights of another
15 person. A device used outside these parameters shall result in confiscation of the device until such
16 time as it may be released to the student's parent/guardian. A student in violation of this policy is
17 subject to disciplinary action.

18 The student who possesses any such device shall assume responsibility for its use and care. At no time
19 shall the school be responsible for theft, loss or damage to devices that are brought on school property.



Misty Shelton
Director of Accountability
Hickman County Schools
115 Murphree Avenue
Centerville, Tennessee 37033

To: School Board Members
From: Misty Shelton
Date: March 22, 2019
Up for 2nd reading: 1.803, 4.209, 4.603
Up for review: 2.701, 2.702, 2.802, 2.803, 2.804, 2.806, 2.900
Up to delete: 6.603, 6.702, 6.706
For consideration: 1.405

Up for 2nd reading:

1.803 Tobacco-Free Schools-This model policy initially used the phrase "e-cigarettes" to refer to the use of vaping devices. Based on the types of vaping devices showing up in districts across the state and the way students are using them, we decided to update this policy with broader language. It now includes the terms "electronic/battery operated devices" and "vapor products" to more clearly include a wider variety of these devices and associated products.

4.209- Alternative Credit Options- We updated this policy to include a provision on the recently created Course Access Program. This program is scheduled to be available to students in the 2019-2020 school year. It will allow students across the state the same access to certain "course access courses" that may not otherwise be available at their schools. The recently created State Board of Education Rule 0520-01-14-.03 outlines the process for the application, approval, and monitoring of the program. It also requires all local boards to adopt a policy for hearing appeals from denials of Course Access Program course enrollments. Our updated policy includes suggested model language.

4.603- Promotion and Retention- State Board Policy 3.300 now includes a new parental notification requirement for students in kindergarten through third grade who are not meeting the expectations of grade-level standards in reading, which must be included in local policy. This State Board policy also now requires districts to compile a list of students that may be considered for retention by February 1st. Local board policies must also list specific circumstances under which students may be considered for retention after that date. We are including examples in the model policy but encourage boards to evaluate which reasons they want to include based on experiences in their individual school systems.

Up for review:

2.701- Financial Reports and Records

2.702- Inventories

2.802-Payroll Procedures

2.803- Salary Deductions

931-729-3391 ext. 2226

misty.shelton@hickmank12.org

fax 931-729-3834

2.804- Expenses and Reimbursements
2.806- Bids and Quotations
2.900- Student Activity Funds Management

Up for deletion:

6.603- Use of Records – Recommend deletion. TSBA model policy covers this information in policy 6.600. The board adopted this version of 6.600 earlier in the year.

6.702- Student Clubs and Organizations – Recommend deletion. TSBA no longer has a model policy with this number. This information is covered in current board policies 4.300 and 6.304. Any additional information can be placed in an administrative procedure.

6.706- Student Performances – Recommend deletion. TSBA no longer has a model policy with this number. They typically recommend placing this type of information in administrative procedures.

For Consideration:

Additionally, TSBA wanted to let you know about a potential legal concern with policy 1.405. This policy states that the rules of order may be suspended by a two-thirds vote (line 14). We recommend against using this language as it conflicts with TCA 49-2-202(g) (“A majority of all of the members constituting the board, and not merely a majority of the quorum, shall be required to transact all business coming before the board in regular or special meetings.”).

Thank you in advance for your careful consideration of these policies.

931-729-3391 ext. 2226

misty.shelton@hickmank12.org

fax 931-729-3834

Hickman County Board of Education			
Monitoring: Review: Annually, in January	Descriptor Term: Financial Reports and Records	Descriptor Code: 2.701	Issued Date: 08/02/99
		Rescinds:	Issued:

1 **FINANCIAL REPORTS**

2 *Central Office*

3 The Executive Committee shall submit to the Board at each regular Board meeting a report of all business
4 transacted since the last regular meeting.¹

5 A report indicating all receipts and expenditures will be given quarterly to the County Commission.²
6 Each report will show the amount of the annual appropriation, the amount expended by account to date,
7 the amount encumbered and the free balance in each account.

8 The director of schools shall submit monthly financial reports to the Board and to state and federal
9 agencies as required.³

10 *Individual Schools*

11 Each principal shall submit to the director of schools at the end of each calendar month on a prescribed
12 form the receipts, expenditures and cash balance of all accounts under his jurisdiction. These reports
13 shall be made available to the Board at its request.

14 **FINANCIAL RECORDS**

15 *General*

16 The director of schools shall maintain all financial records as required by regulation and applicable state
17 and federal law. The Board, from time to time, may determine to extend the retention time for certain
18 records.⁴

Legal References:

1. TCA 49-2-206(5)
2. TCA 49-2-301(b)(11)(S)
3. TCA 49-2-301(b)(1)(Z)
4. *Tennessee Internal School Uniform Accounting Policy Manual*; Section 4-21

Cross Reference:

School Board Records 1.407

Hickman County Board of Education			
Monitoring: Review: Annually, in January	Descriptor Term: Inventories	Descriptor Code: 2.702	Issued Date: 09/09/10
		Rescinds: 2.702	Issued: 04/02/07

1 *General*

2 The director of schools shall establish an accurate inventory procedure for all school real and personal
3 (e.g., material and equipment) property, and this system shall be implemented at each school facility.
4 Equipment is defined as all items with a unit cost of \$5,000.00 or more and a minimum useful life
5 expectancy of three years (including freight and installation charges)*. Minor sensitive equipment is
6 defined as having a value of \$100.00 to \$5,000.00 (technology equipment and related support
7 equipment).¹ Administrative personnel shall ensure that a physical count of all such property is taken at
8 the end of each fiscal year, and this inventory shall be properly entered on the appropriate records for
9 accounting purposes.²

10 Each school shall maintain a complete inventory with a duplicate maintained in the central office.

11 **EQUIPMENT PROCURED WITH FEDERAL DOLLARS**

12 The director shall establish procedures for administrators to follow which meet all federal accountability
13 guidelines, including guidelines for the purchasing, inventorying, security and disposition of all
14 equipment purchased with federal funds.³

Legal References:

1. ED - 5091 Education Department - Fed.
2. Tennessee Internal School Uniform Accounting Policy Manual; Section 4-13
3. EDGAR 43 Subtitle A Part 80.32 Education Department General Admin. Regulation
34 CFR 80.3-52

Cross References:

- Personal Property Sales 2.403
- Security 3.205
- Equipment & Supplies Management 3.30

* As defined by Tennessee Department of General Services

Hickman County Board of Education			
Monitoring: Review: Annually, in January	Descriptor Term: Payroll Procedures	Descriptor Code: 2.802	Issued Date: 08/02/99
		Rescinds:	Issued:

1 *Central Office*

2 If the end of a pay period falls on a non-working day, employees will be paid on the last working day
3 prior to the end of the pay period.

4 Payroll procedures shall be as follows:

- 5 1. All certified personnel have the option of either ten (10), or twelve (12) month installments.
6
7 2. All non-certificated personnel shall have the option of either ten (10) or twelve (12) months
8 installments.

9 No advance payments of salary shall be made. Upon resignation or retirement of school personnel, final
10 salary payment shall be withheld until all records and assets in custody of the employee are satisfactorily
11 transferred to his successor or another designated person.

12 Specific approval by the Board is required for payroll deductions, except as otherwise provided by law.

Cross References:

- Compensation Guides and Contracts 5.110
- Resignation 5.204
- Retirement 5.205

Hickman County Board of Education

Monitoring: Review: Annually, in January	Descriptor Term: Salary Deductions	Descriptor Code: 2.803	Issued Date: 08/02/99
		Rescinds:	Issued:

1 *Central Office*

2 Upon appropriate written authorization, the Board shall make deductions approved by the Board from
3 the salary of the employee. Authorization must be made on forms provided by the Board and filed in
4 the office of the director of schools within sufficient time to be processed before the issuance of the first
5 payroll check.

Cross Reference:

Insurance Management 3.600

Hickman County Board of Education			
Monitoring: Review: Annually, in January	Descriptor Term: Expenses and Reimbursements	Descriptor Code: 2.804	Issued Date: 08/02/99
		Rescinds:	Issued:

1 *Central Office*

2 Annually the Board shall review expense allowances and reimbursement guidelines.

3 **SCHOOL PERSONNEL**

4 School personnel who incur expenses in carrying out their authorized duties will be reimbursed upon
5 submission of an approved voucher and supporting receipts.

6 Expenses for travel will be reimbursed when the travel has the advance authorization of the director of
7 schools. The director of schools may grant this authorization without prior board action when the travel
8 expense has been anticipated and incorporated into the operational budget of the particular program
9 involved.

10 Mileage will be paid at a rate authorized by the Board.

11 The Board shall be responsible for all expenses pertaining to staff development. Student activity funds
12 shall not be used for this purpose.¹

13 **BOARD MEMBERS**

14 The members of the Board shall be paid for transportation, lodging, meals and other pertinent expenses
15 when traveling on business for the Board. Salary and other benefits shall be determined by the County
16 Commission.² Attendance at conventions or other educational meetings or travel for other school
17 purposes shall be authorized in advance by the Board.³

18 Expenses shall be submitted to the director of schools' office within thirty (30) days of the date of
19 completion of such travel. The rate of payment shall be the same as the rate for members of the
20 professional staff.

Legal References:

1. *Tennessee Internal School Uniform Accounting Policy Manual*, Section 5-20
2. TCA 49-2-202(d)
3. TCA 49-2-2001(c)

Hickman County Board of Education			
Monitoring: Review: Annually, in January	Descriptor Term: Bids and Quotations	Descriptor Code: 2.806	Issued Date: 10/02/06
		Rescinds: 2.806	Issued: 08/02/99

1 **General**

2 All purchases of supplies, materials, equipment and contractual services shall be purchased and/or bid
3 under the same criteria as *(the local governmental body)*.¹

4 **EXEMPTIONS FROM COMPETITIVE BIDDING**

5 Contracts for legal services, educational consultants, insurance purchased through a plan authorized and
6 approved by any organization or governmental entities representing cities and counties² and similar
7 services by professional persons or groups of high ethical standards shall not be based upon competitive
8 bids, but shall be awarded on the basis of recognized competence and integrity.³

Legal References:

- 1. Public Acts 2006, Public Chapter 567
- 2. TCA 29-20-407
- 3. TCA 12-4-106

Hickman County Board of Education			
Monitoring: Review: Annually, in January	Descriptor Term: Student Activity Funds Management	Descriptor Code: 2.900	Issued Date: 03/02/09
		Rescinds: 2.900	Issued: 06/03/02

1 *Individual Schools*

2 The activity funds of each school shall include athletic and student organization funds and any other
3 fund belonging to any student group, class, or activity.

4 Whatever the source, all student activity funds shall be under the jurisdiction of the Board and under the
5 specific control of the school principal. Contracts with fund-raising agencies must comply with board
6 policy and be approved in writing by the director of schools. Budget for these accounts shall be
7 submitted by October 1.

8 Principals and/or sponsors who knowingly authorize/allow unapproved fund-raising activities shall be
9 subject to disciplinary action.¹

10 Student activity funds shall be deposited in respective school activity accounts. Proper records of
11 receipts and disbursements shall be maintained in accordance with the *Tennessee Internal School*
12 *Uniform Accounting Policy Manual*.²

13 Revenue raised for specific purposes must be expended for that purpose, unless otherwise authorized in
14 writing by both the activity group sponsor and the principal.³

15 An annual audit of the account and records of all student activity funds shall be conducted as a part of
16 the audit of all other district funds.⁴

17 Any unencumbered class or activity funds automatically revert to the general activity fund of the school
18 when a class graduates and chooses not to use the funds for a designated purpose or an activity is
19 discontinued.

20 Funds derived from activities sponsored by parent-teacher associations, parent-teacher organizations or
21 other support organizations are not subject to this policy, unless such funds are in sole custody of the
22 school.⁵

23 **COOPERATIVE ACTIVITIES**

24 Certain activities which contribute to the general welfare of students do not easily lend themselves to
25 classifications solely as school activities. Other activities by their nature involve cooperative effort with
26 groups outside the student body. The benefits of such student activities shall be preserved if procedures
27 can be established to provide proper accounting funds involved and to ensure substantial adherence to
28 the principals governing students activity finance.

Legal References:

1. *Tennessee Internal School Uniform Accounting Policy Manual*; Section 4-26
2. TCA 49-2-110(c)(d)
3. Tennessee Internal School Uniform Accounting Policy Manual; Section 5-25
4. TCA 49-2-112(a)
5. TCA 49-2-110(e)

Cross References:

- Parent Organizations/Booster Clubs 4.503
- Student Solicitations/Fund-Raising 6.701

Hickman County Board of Education

Monitoring: Review: Annually, in May	Descriptor Term: Student Records Use of Records	Descriptor Code: 6.603	Issued Date: 11/04/02
		Rescinds: 6.603	Issued: 08/02/99

1 Authorized school officials will have access to and permit access to student education records for
2 legitimate educational purposes.¹ A “legitimate educational interest” is the official’s need to know
3 information in order to:

- 4 1. Perform required administrative tasks;
- 5
- 6 2. Perform a supervisory or instructional task directly related to the student’s education;
- 7
- 8 3. Perform a service or benefit for the student or the student’s family such as health care, counseling,
9 student job placement, or student financial aid.

10 Authorized school officials may release information from or permit access to a student’s education
11 record without the parent(s) or eligible student’s* prior written consent in the following instances:

- 12 1. To comply with a judicial order or lawfully issued subpoena. The school system will make a
13 reasonable effort to notify the student’s parent(s) or the eligible student before making a
14 disclosure;
- 15
- 16 2. If the disclosure is an item of directory information;
- 17
- 18 3. To comply with the requirements of child abuse reports to the extent known by the school
19 officials including the name, address and age of the child, the name and address of the person
20 responsible for the care of the child, and the facts requiring the report;²
- 21
- 22 4. When certain federal and state officials need information in order to audit or enforce legal
23 conditions related to federally-supported education programs in the school system;
- 24
- 25 5. When the school system has entered into a contract or written agreement for an organization to
26 conduct scientific research on the system’s behalf to develop tests or improve instruction,
27 provided that the studies are conducted in a manner which will not permit the personal
28 identification of students and their parents by individuals other than representatives of the
29 organization and the information will be destroyed when no longer needed for the purpose for
30 which the study was conducted;³
- 31
- 32 6. To appropriate officials if the parent(s) claim the student as a dependent as defined by the Internal
33 Revenue Code;
- 34
- 35 7. To accrediting organizations to carry out their accrediting functions;

- 1 8. When a student seeks or intends to enroll in another school district or a post-secondary school.
2 Parent(s) of students or eligible students have a right to obtain copies of records transferred under
3 this provision;⁴
- 4 9. To financial institutions or government agencies that provide or may provide financial aid to a
5 student in order to establish eligibility, to determine the amount of financial aid, to establish
6 conditions for the receipt of financial aid and to enforce financial aid agreements.
7
- 8 10. To make the needed disclosure in a health or safety emergency when warranted by the
9 seriousness, of the threat to the student of other persons, when the information is necessary and
10 needed to meet the emergency, when time is an important and limiting factor and when the
11 persons to whom the information is to be disclosed are qualified and in a position to deal with
12 the emergency.
13
- 14 11. To the Attorney General or his designee for official purposes related to the investigation or
15 prosecution of an act of domestic or international terrorism. An educational agency that, in good
16 faith, produces education records in accordance with an order issued under this Act shall not be
17 liable to any person for that production.⁵

18 Authorized school officials may release information from a student's education record if the student's
19 parent(s) or the eligible student gives written consent for the disclosure. The written consent must
20 include:

- 21 1. A specification of the records to be released;
- 22 2. The reasons for the disclosure;
- 23 3. The person, organization, or class of persons or organizations to whom the disclosure is to be
24 made;
- 25 4. The signature of the parent(s) or eligible student;
- 26 5. The date of the consent and, if appropriate, a date when the consent is to be terminated. The
27 student's parent(s) or the eligible student may obtain a copy of any records disclosed under this
28 provision.

29 The school system will maintain an accurate record of all requests to disclose information from or to
30 permit access to a student's education records. The system will maintain an accurate record of
31 information it discloses and access it permits. The system will maintain this record as long as it maintains
32 the student's education record.

33 The record will include at least:

- 34 1. The name of the person or agency that makes the request;
- 35 2. The interest the person or agency has in the information;
- 36 3. The date the person or agency makes the request; and
- 37 4. Whether the request is granted and, if it is, the date access is permitted or the disclosure is made.

Legal References:

1. USCA 20-1232g; TCA 10-7-503; TCA 10-7-504
2. TCA 37-1-403
3. TRR/MS 0520-1-9-.14(7)(h)-(k)
4. TRR/MS 0520-1-3-.03(11)(e)

Hickman County Board of Education

Monitoring: Review: Annually, in May	Descriptor Term: Student Clubs and Organizations	Descriptor Code: 6.702	Issued Date: 09/10/01
		Rescinds: 6.702	Issued: 08/02/99

1 Student organizations are an extension of the academic curriculum and are intended to complement the
2 basic instructional program.

3 The principal, in cooperation with the faculty and student body representatives, shall approve all clubs
4 and organizations within the school.

5 Official club meetings shall be scheduled through the office at the beginning of the school year. No
6 more than one club meeting should be scheduled per month, including 4-H Club.

7 One or more staff members will serve as sponsors of each activity and will attend all meetings. Each
8 sponsor will evaluate the activity and make recommendations concerning changes, continuance, or
9 deletion from the school's activity program.

10 An approved copy of the aims, objectives, and constitution for each organization will be kept on file in
11 the principal's office.

12 No student should be allowed to hold the office of president of more than one organization. Further
13 office duplication should be left to the discretion of the club's sponsor.

14 The director of schools shall approve all requirements imposed by clubs which have restricted
15 membership.

16 HAZING

17 The nature of any initiation shall be outlined and presented in writing to the club sponsor and the
18 principal of the school for approval prior to the actual initiation. Hazing by students acting alone or with
19 others is strictly prohibited. Any organization which permits an initiation to go beyond the scope of
20 activities planned and previously approved will be suspended until reinstated by the principal. ¹

21 Sororities, fraternities, and all secret organizations are prohibited.

Legal Reference:

1. TCA 49-2-120; TCA 49-6-3401

Hickman County Board of Education

Monitoring: Review: Annually, in May	Descriptor Term: Student Performances	Descriptor Code: 6.706	Issued Date: 08/02/99
		Rescinds:	Issued:

1 The following guidelines shall be used by principals in determining whether or not students may
2 participate in community-sponsored activities during school hours:

- 3 1. The participation in the project will not deprive students of time needed for acquiring basic
4 skills.
- 5 2. The regular schedule will not be interrupted unless the majority of the students benefit through
6 their participation.
- 7 3. Neither an individual nor the school as a whole shall be permitted to use school time in working
8 on community-sponsored projects unless such an undertaking is contributing to the educational
9 program.
- 10 4. If the performance is school-sponsored and is open to the public, it shall be physically accessible
11 to all students, their parents and/or guardians, and other interested citizens.¹
12
13
14

Legal Reference:

1. 28 CFR § 201-202

Cross Reference:

Section 504/ADA Grievance Procedures 1.802



**STATE OF TENNESSEE
DEPARTMENT OF FINANCE AND ADMINISTRATION
BENEFITS ADMINISTRATION**

**312 Rosa L. Parks Avenue
Suite 1900 William R. Snodgrass Tennessee Tower
Nashville, Tennessee 37243-1102
Phone (615) 741-3590 or (800) 253-9981
FAX (615) 253-8556**

**Stuart C. McWhorter
COMMISSIONER**

**Laurie Lee
EXECUTIVE DIRECTOR**

**MEMORANDUM OF UNDERSTANDING
BETWEEN THE STATE OF TENNESSEE
AND LOCAL EDUCATION AGENCY**

TERMS AND DEFINITIONS

1. **Additional Benefits** means benefit plans offered separately by Local Education Agencies, including those which provide (a) dental benefits, (b) vision benefits, (c) long-term care benefits, (d) disability insurance benefits, (e) life insurance benefits, (f) tort liability or workers' compensation benefits, (g) benefits for a specific disease and/or illness (e.g., cancer, heart, stroke), (h) benefits limited to a fixed amount per day (or other period) of hospitalization, (i) accident, death, and dismemberment benefits and (j) any other benefits approved in writing by the Division of Benefits Administration. Any of the above listed plans or policies which reimburses, subsidizes, supplements or pays the costs of participating in the Local Education Health Insurance Plan, or provides coverage, subsidies, credits or payouts of any kind for or related to services or pharmaceuticals covered by the Local Education Health Insurance Plan, including co-pays, member contributions, coinsurance and deductibles, **must** be submitted to benefits.info@tn.gov and approved in writing by the Division of Benefits Administration.
2. **Agency Benefits Coordinator (ABC)** means an individual who serves as the liaison between the State Group Insurance Program, members and Benefits Administration.
3. **Annual Enrollment** means a period in the fall when members are able to change, add or remove benefits. Specific dates for this period are set by Benefits Administration each year.
4. **ACH** means Automatic Clearing House.
5. **Benefits Administration (BA)** means the division of the Tennessee Department of Finance & Administration that administers the State Group Insurance Program.
6. **Business Days** means traditional workdays, including Monday, Tuesday, Wednesday, Thursday and Friday. State government holidays are excluded.

7. **Calendar Days** means all seven days of the week.
8. **CFR** means Code of Federal Regulations.
9. **COBRA** means Consolidated Omnibus Budget Reconciliation Act.
10. **Day(s)** means Calendar Day(s) unless otherwise specified in the MOU.
11. **Edison** means the State's enterprise resource planning system for the administration of benefits enrollment and premium data.
12. **GASB** means Governmental Accounting Standards Board.
13. **HIPAA** means Health Insurance Portability and Accountability Act of 1996, Public Law 104-191 and implementing regulations.
14. **HITECH** means Health Information Technology for Economic and Clinical Health Act.
15. **LEA** means Local Education Agency.
16. **Local Education Health Insurance Plan** (also Local Education Plan) means the insurance plans authorized by Tenn. Code Ann. 8-27-302(a).
17. **Local Education Insurance Committee** means the policy making body for the Local Education Insurance Plan established under Tennessee state law.
18. **Local Education Plan Document** (also Plan Document) means the legal publication that defines eligibility, enrollment, benefits and administrative rules of the Local Education Health Insurance Plan.
19. **Member** means any person who is enrolled in one of the medical benefit or voluntary benefit plan options offered through the Local Education Plan.
20. **MOU** means Memorandum of Understanding.
21. **Notify**, unless otherwise specified within this MOU, means to notify Benefits Administration in writing, and the notification may be delivered by electronic mail, facsimile or the U.S. Postal Service.
22. **OPEB** means Other Post-Employment Benefits (other than pensions) that an employee is eligible to receive at the start of retirement.
23. **PHI** means Protected Health Information.
24. **PPACA** means Patient Protection and Affordable Care Act, Public Law 111-148 as amended by Public Law 111-152.
25. **State** means the State of Tennessee.
26. **State Government Holidays** means those days on which official holidays and commemorations as defined in Tennessee Code Annotated 15-1-101 et seq. are observed.
27. **State Group Insurance Program** means the system operating the insurance plans and benefits for individuals from public sector organizations in Tennessee. The program is operated under the authority of the Local Education Insurance Committee and managed by Benefits Administration within the Department of Finance and Administration.
28. **TCA** means Tennessee Code Annotated.
29. **TCRS** means Tennessee Consolidated Retirement System.

30. **The Tennessee Plan** means the plan offering supplemental medical insurance for retirees with Medicare as defined in Tenn. Code Ann. 8-27-209.
31. **Voluntary Benefits** means benefits other than health insurance benefits which are established and offered by the Local Education Insurance Committee, and fully paid by the employee as defined in Tenn. Code Ann. 8-27-104. Examples include dental and vision insurance.
32. **Website** means the ParTners for Health Website (www.tn.gov/partnersforhealth), which includes a section specifically for ABCs. ParTners for Health and ABC information, including publications and forms, can be accessed from this site by going to www.tn.gov/partnersforhealth.

INTRODUCTION

This Memorandum of Understanding (MOU) defines the administrative responsibilities of the Tennessee Department of Finance and Administration, Benefits Administration ("BA") and the _____, an eligible Local Education Agency ("LEA"), for the provision of group health plan coverage through the State of Tennessee Local Education Health Insurance Plan ("Local Education Plan"), and any available voluntary benefit plans pursuant to TCA 8-27-302 *et seq.* and TCA 8-27-104.

The Local Education Plan Document ("Plan Document"), approved by the Local Education Insurance Committee pursuant to TCA 8-27-302(a) that defines the eligibility, enrollment, benefits and administrative provisions for the Local Education Insurance Plan. Tenn. Code Ann. 8-27-303(h) requires LEAs to implement and comply with the financial determination of the Insurance Committee, including entering into an MOU. Should any terms of this MOU conflict with any provision of the Plan Document, the Plan Document and Summary Plan Description for The Tennessee Plan (Supplemental Medical Insurance for Retirees with Medicare), or the current certificates of coverage for voluntary benefits, the provisions of those Plan Documents and/or certificates shall control.

This MOU supersedes and replaces all prior MOUs, agreements or other documentation between BA and the LEA describing the responsibilities of the parties with respect to such group benefits.

SECTION 1A - RESPONSIBILITIES OF THE LEA

1. The LEA and its officers and employees shall abide by and enforce all the eligibility criteria for all benefit options offered, including but not limited to, the health plan which is outlined in the Local Education Plan Document, the Plan Document and Summary Plan Description for The Tennessee Plan, and the current certificates of coverage for voluntary benefits.

Individual agencies shall not determine eligibility in a way that conflicts with the Local Education Plan Document or eligibility documents for the voluntary benefit plans, including the Plan Document for The Tennessee Plan and the certificates of coverage. For example, the LEA shall not use a different set of required hours worked to be eligible.

The eligibility, enrollment, benefit and administrative provisions of the Plan Document, the Plan Document for The Tennessee Plan, or the current certificates of coverage for voluntary benefits shall be uniformly enforced by the LEA.

The LEA shall offer ALL options of the medical plans, including any carriers, networks or plan types available to them. If the LEA elects to participate in the voluntary benefit plans, the LEA shall offer ALL options of those voluntary plans to employees for their selection, including any carriers, networks or plan types available to them.

2. At execution of this MOU, the LEA shall identify a contact person within the organization to serve as an Agency Benefits Coordinator ("ABC"). The ABC must be an employee of the LEA responsible for

plan administration and be a liaison between the LEA, its employees and BA. Only ABCs shall have data update and/or inquiry access to Edison for the employees of the agency and their dependents. In no event shall an ABC allow an insurance agent, insurance broker or insurance agency access to Edison. Duties and responsibilities of the ABC are outlined in Section 2 of this document.

3. The LEA shall notify BA within ten (10) business days after a current ABC terminates employment or is no longer responsible for the duties of an ABC. The LEA shall also provide BA with contact information for the new ABC immediately upon designation.
4. The LEA shall notify BA within ten (10) business days of the appointment or election of a new director or superintendent of schools.
5. The LEA shall assist BA with any audits and other requests related to the compliance of all parties with the Plan Document, the Plan Document for The Tennessee Plan, or eligibility rules for the voluntary plans within fifteen (15) business days of the request.

The LEA shall be responsible for a financial assessment equal to any expense assessed to BA as a result of the LEA's failure to provide information as requested. BA may deduct assessed expenses from the LEA's Automatic Clearing House (ACH) debit account. BA reserves the ability to waive the assessment as it deems appropriate, and its decisions shall not be subject to appeal or review.

6. The LEA shall respond to survey and information requests from BA within fifteen (15) business days, including but not limited to surveys related to (a) employer/participating agency premium contributions for employees and dependents; (b) employer/participating agency contribution levels based on retirees' years of service for Government Accounting Standards Board Statement #75 (GASB 75)/Other Post-Employment Benefits (OPEB) purposes; and (c) documentation, including pamphlets, enrollment materials, policies, etc. of all additional benefits and other products offered by the employer/participating agency.

Failure of the LEA to provide the information required by paragraph number 6 may result in BA assessing and collecting the costs incurred by the LEA's failure to cooperate. This assessment may include actuarial consulting fees and the additional cost to the plan caused by non-compliance. In addition, non-compliance may also result in termination of the LEA's participation in the plan. Additionally, the LEA's failure to provide the requested survey information with regard to data required for an OPEB calculation required by GASB 75 shall result in said LEA being excluded from the annual actuarial calculations, valuations and OPEB liability determinations by the actuaries under contract with the State's Department of Finance & Administration. BA reserves the ability to waive the assessment as it deems appropriate, and its decisions shall not be subject to appeal or review.

7. The LEA shall remit the premiums for health and any voluntary plans of coverage if applicable, by means of an ACH debit account. The LEA shall provide the Department of Finance & Administration with at least sixty (60) days' notice before making any change to its bank account or other information that may impact ACH transactions. The LEA shall use the ACH form, instructions and contact information available under the Agency Benefits Coordinator section of the Website as described in item 32 of the Terms and Definitions section of this MOU.
8. LEA participation in the Local Education Plan shall continue for at least twenty-four (24) consecutive months unless the LEA is determined to be in violation of requirements which necessitates termination by the Local Education Committee.
9. If the LEA discontinues participation in the Local Education Plan, the LEA may not rejoin the Local Education Plan for twenty-four (24) consecutive months, following the date of termination. The LEA shall provide BA with a sixty (60)-day written notice before terminating its participation with the Local Education Plan. BA will terminate any COBRA or retiree participants, including retirees billed through their TCRS pension or direct bill, from the Plan, along with the active employees if the LEA terminates participation. Pursuant to TCA 8-27-303(£) the agency's new medical insurance plans must

be determined to be "equal or superior" to the Local Education Plan's offerings. Should the new plans be determined not to be "equal or superior", direct payments from the Department of Education shall be discontinued no later than ninety (90) days after the final determination is made. See Exhibit A, Plan Withdrawal Document with Equal or Superior Policy, for more detail regarding the withdrawal process.

10. A LEA participating in the Local Education Health Insurance Plan may offer the state-sponsored voluntary plan(s) to its employees and retirees. The dental and/or vision voluntary plan(s) may be effective on the agency's original effective date or on a subsequent January 1. The LEA must submit a written intent to enroll notice to BA by July 1, or another date announced by BA, of the year preceding the January 1 effective date for dental and/or vision. LEA participation in the dental plan and/or vision plan shall continue for at least twelve (12) consecutive months coinciding with a calendar year. The LEA shall provide BA with a sixty (60) day written notice before terminating its participation in the voluntary plans. If the LEA discontinues participation in the dental and/or vision plan, the LEA acknowledges that its employees will not be eligible for COBRA and that the LEA may not rejoin the dental and/or vision plan for at least twelve (12) consecutive months, beginning on the date of termination. If the LEA rejoins the dental and/or vision plan, eligible employees may sign up during the next annual enrollment period. (For example, an agency that drops the dental plan as of 3/1/18 would not be able to offer the dental plan again until 1/1/20.) If a LEA discontinues participation in the medical insurance plan, participation in the voluntary plans will terminate on the same date as the medical insurance plan.
11. Prohibition on other coverages:
 - (a) A LEA participating in the Local Education Health Insurance Plan **shall not** offer, subsidize or incentivize enrollment of individuals eligible for the state-sponsored group insurance program into any health plan, health insurance policy or medical expenses plan other than the state sponsored group insurance plan (including state offered voluntary benefits) and those plans which constitute "additional benefits" as defined in (b) below. A LEA participating in the Local Education Plan may offer additional benefits approved by Benefits Administration, instead of or in addition to the voluntary benefits in the state group insurance program.
 - (b) For the purpose of (a) above, the term "health plan" includes any health plan or policy, medical insurance plan or policy, excepted benefit policy, supplemental benefit policy, gap or bridge policy and any plan or policy that reimburses, indemnifies, contributes to, supplements or pays the costs of participating in the Local Education Health Insurance Plan, or provides coverage, subsidies or credits for services or pharmaceuticals covered by the Local Education Health Insurance Plan, including co-pays, member contributions, coinsurance and deductibles. For purposes of this MOU, this definition of "health plan" is not affected by whether a plan, or expenses paid under a plan, is considered a supplemental plan, health plan or an excepted benefit under Federal law.
 - (c) Failure of the LEA to provide the information required by paragraph number 6 regarding additional benefit plans may result in Benefits Administration assessing and collecting the costs incurred by the LEA's failure to cooperate. This assessment may include actuarial consulting fees and the additional cost to the plan caused by non-compliance. In addition, non-compliance may also result in termination of the LEA's participation in the plan.
 - (d) A LEA's offering, subsidizing or incentivizing participation in any product prohibited by section (a) above may result in Benefits Administration assessing and collecting the costs incurred by the LEA 's failure to cooperate. This assessment may include actuarial consulting fees and the additional cost to the plan caused by non-compliance. In addition, non-compliance may also result in termination of the LEA's participation in the plan.
12. If the LEA does not have any employees enrolled in health coverage for more than sixty (60) days, the agency will be terminated from the Local Education Plan and shall be ineligible to re-join the Local Education Plan for at least twenty-four (24) months.
13. The LEA shall abide by the refund policy as stated in the Local Education Plan Document, with the

understanding that any ineligible claims will be recovered before a refund is released to the agency.

14. The LEA has the primary responsibility for determining eligibility pursuant to the provisions of the Plan Document and/or the voluntary benefits eligibility documents. The LEA may refer any eligibility question to BA for written clarification. In the absence of such written clarification, the LEA shall reimburse the State for the cost of benefits provided because of any inaccurate representation of eligibility that its employees may make that result in an otherwise ineligible individual becoming enrolled for and receiving benefits. The LEA shall terminate enrollment for the employee and dependents and notify BA when it is discovered that an employee and/or dependent(s) was ineligible for coverage.
15. All LEAs shall download the Premiums Due Collections Applied reports through Edison (the State's enterprise resource planning system used for the administration of benefits enrollment and premium data). If the LEA fails to download such reports and requests hard copies, the LEA shall first pay an annual fee of six hundred dollars (\$600.00) to BA payable/collected through the ACH debit account. BA reserves the authority to waive the annual fee as it deems appropriate, and its decisions shall not be subject to appeal or review.
16. If the LEA has more than twenty-five (25) members, it shall maintain two (2) ABCs who have access to Edison at all times. For security purposes, no LEA shall have more than two ABCs with Edison access unless additional ABCs have been authorized by BA.
17. Each ABC shall perform data entry in Edison. This includes adding biographical and job information for all employees.
18. The LEA may request in writing a copy of its claims experience and/or enrollment information from BA. BA will only provide a copy of such report results directly to the ABC or other authorized LEA employee. At no time shall BA deliver such report to an insurance agent or broker. Such report shall not contain any personal identifiers or individual claims detail or other information restricted by HIPAA. The guidelines for release of claims and enrollment information and the formal "Request for Enrollment and Claims Information" are governed by Tenn. Code Ann. § 8-27-302 (g). Assistance with the request process may be found on the ABC section of the Partners for Health website at https://www.tn.gov/content/dam/tn/finance/fa-benefits/documents/abc_release_claims_enroll.pdf.
19. The LEA shall notify BA within five (5) business days of receipt of a Medicare demand letter or other notice explaining that Medicare may have made a primary payment for services instead of a secondary payment for services. The LEA shall deliver a copy of such letter or other notice via facsimile, electronic mail or hard copy delivery within the same five-day time period.
20. The LEA shall maintain an up-to-date insurance file on each participating member which shall include, at a minimum, the signed "Employee Insurance Checklist - Local Education Plan" (a copy may be found on the ABC section of the website at www.tn.gov/partnersforhealth/agency-benefits-coordinators), a copy of any manually completed enrollment forms and a copy of any Edison reports reflecting benefits chosen by the member. The LEA can maintain either an electronic or hard copy (or both). Copies of files may be requested by BA for audit determination.
21. The LEA shall be responsible for complying with all employer reporting requirements and employee notifications required under the Patient Protection and Affordable Care Act (PPACA). Each agency on the Plan is considered to be a self-insured employer and must follow the self-insured reporting guidelines.
22. The LEA shall be responsible for any penalties imposed for failure to comply with PPACA.
 - (a). This responsibility includes but is not limited to penalties under the PPACA amendments to the Public Health Service Act (42 U.S.C. 300 gg et seq), the employer responsibility section of the Internal Revenue Code (26 U.S.C. 4980H), and regulations implementing those provisions.
 - (b). The LEA shall also reimburse BA for any expenses caused by the LEA's failure to terminate coverage in Edison when that failure leads to claims being paid after the coverage should have

been terminated. This could create a risk of a rescission under the PPACA regulations if untimely notice leads to retroactive termination.

23. For each member termination, the LEA shall enter the termination into Edison or notify BA if the ABC does not have access to Edison within five (5) business days of the termination. The LEA shall reimburse the State for any penalties, fines, assessments or damages incurred associated with late COBRA and other notices that result from a delayed notification from the LEA to BA of the termination of an employee or member. Any termination entered after five (5) business days from the date of termination, shall be subject to premium refund provisions of the Local Education Plan Document.
24. To the extent that the LEA varies its employer contribution by benefit option, third party administrator or premium tier, the LEA assumes all compliance duties and risks associated with the statutory requirements of federal and state law, including but not limited to the nondiscrimination and wellness requirements in the Health Insurance Portability and Accountability Act (HIPAA, Pub. L. 104-191) as amended and the Americans with Disability Act (ADA, Pub. L. 101-336), as amended. The LEA may refer to "Contributions" in the Local Education Plan Document and any other publications or frequently asked questions (FAQs) which BA may publish for information regarding the State's contribution policy. The LEA shall also consult with its legal counsel to ensure that the LEA's approach is in compliance with all applicable legal requirements.
25. In the event that a change in federal laws or regulations, including but not limited to COBRA, requires changes in the procedures set out in Section I of this MOU, the LEA will comply with those requirements regardless of whether this MOU is formally amended.
26. Hold Harmless. The LEA agrees to reimburse the State for financial losses caused by the LEA's violation of Federal laws or regulations governing the conduct of a health insurance plan. Such Federal provisions include, but are not limited to the Patient Protection and Affordability Act (PPACA); the Health Insurance Portability and Accountability Act (HIPAA), the Health Information Technology for Economic and Clinical Health Act (HITECH), and the Consolidated Omnibus Budget Reconciliation Act (COBRA). The LEA's responsibility under this provision includes any fines, penalties or legal costs incurred by the State as a result of the LEA's violation of Federal law.

SECTION 1B-OTHER RESPONSIBILITIES OF THE LOCAL EDUCATION AGENCY - OBLIGATIONS AND ACTIVITIES WITH REGARDS TO HIPAA

HIPAA and HITECH Compliance

1. The LEA shall comply with obligations under HIPAA and HITECH and their accompanying regulations. The Local Education Plan is a covered entity under the Administrative Simplification Provisions of HIPAA. The LEA shall take all appropriate measures to protect the privacy and security of the protected health information it receives from members electing coverage under the Plan. All agency employees who have access to Edison insurance benefits are required to complete the annual HIPAA training online. Failure to comply with mandatory training requirements may result in suspension of insurance benefits access. Training requirements will not be waived unless approved in advance by the BA HIPAA compliance officer.
2. The LEA warrants that it is familiar with the requirements of HIPAA and HITECH and their accompanying regulations and shall comply with all applicable HIPAA and HITECH requirements in the course of this Contract, including but not limited to the following:
 - Compliance with the Privacy Rule, Security Rule, Notification Rule;
 - The creation of and adherence to sufficient Privacy and Security Safeguards and Policies;
 - Timely reporting of violations in use and disclosure of PHI; and
 - Timely reporting of privacy and/or security incidents.
3. The LEA warrants that it will cooperate with the covered entity, including cooperation and coordination with covered entity privacy officials and other compliance officers required by HIPAA

and HITECH and its regulations, in the course of performance of the duties so that both parties will be in compliance with HIPAA and HITECH.

Privacy & Confidentiality

1. The LEA shall develop, adopt and implement standards, which are, at a minimum, compliant with the HIPAA privacy and security rules in 45 CFR Part 164, to safeguard the privacy and confidentiality of all PHI about members. For example, the LEA shall ensure that it does not have completed forms containing PHI sitting in public view, left in unsecured boxes or files or left unattended in any off-site location (e.g., in an automobile). The LEA's procedures shall include but not be limited to safeguarding the identity of members as members of the State Group Insurance Program and preventing the unauthorized disclosure of PHI. The LEA shall comply with the HIPAA amendments in Public Law 111-5, the HITECH Act, and any implementing regulations when they become effective.
2. The PHI shall be used for the purposes of carrying out the responsibilities of this MOU related to the LEA's participation in the Local Education Insurance Plan.
3. The LEA shall not use or further disclose PHI other than as permitted or required by HIPAA; or as required by law. Use of PHI for payment, treatment or health care operations may include disclosure only as permitted by HIPAA, including when such information is strictly necessary to resolve the issue or concern under discussion and the person has adequate permission or legal authority to review such information.
4. The LEA shall use appropriate safeguards to prevent the unauthorized use or disclosure of the PHI. The LEA shall report to the State any unauthorized use or disclosure of the PHI.
5. The LEA shall mitigate, to the extent practicable, any harmful effect that is known to the LEA of a use or disclosure of PHI by the LEA in violation of the requirements of the federal privacy rule.
6. The LEA shall provide access to PHI in a "designated record set" in order to meet the requirements under 45 CFR §164.524.
7. The LEA shall make any amendment(s) to PHI in a "designated record set" pursuant to 45 CFR §164.526.
8. The LEA shall document disclosures of PHI and information related to such disclosures as would be required to respond to a request by an individual for an accounting of disclosures of PHI in accordance with 45 CFR §164.528.
9. The LEA shall cooperate in making relevant records available to the secretary of health and human services for determining HIPAA compliance when required by 45 CFR 164.504(e)(2)(ii)(I)
10. The LEA shall (i) implement administrative, physical and technical safeguards that reasonably and appropriately protect the confidentiality, integrity and availability of the electronic PHI that it creates, receives, maintains or transmits, (ii) report to the State any security incident (within the meaning of 45 CFR § 164.304) of which the LEA becomes aware, and (iii) ensure that any agent of the LEA, including any subcontractor, agrees to the same restrictions and conditions that apply to the LEA with respect to such information.
11. The LEA shall comply with all privacy and security requirements of the Health Insurance Portability and Accountability Act (HIPAA) of 1996 and the Health Information Technology for Economic and Clinical Health (HITECH) Act. Unless the State prior approves in writing the LEA's use of alternate mitigating controls, the LEA shall use Federal Information Processing Standards (FIPS) 140-2 compliant technologies to encrypt all PHI in motion or rest, including back-up media.
12. The LEA shall have full financial responsibility for any penalties, fines or other payments imposed or required as a result of the LEA's non-compliance with or violation of HIPAA or HITECH

requirements, and the LEA shall indemnify the State with respect to any such penalties, fines, or payments.

13. The LEA is authorized to use PHI for the purpose of carrying out its duties under the MOU. In the course of carrying out these duties, including but not limited to carrying out Benefits Administration's duties under HIPAA. LEA shall fully comply with the requirements under the Privacy Rule applicable to "business associates", as that term is defined in the Privacy Rule and not use or further disclose PHI other than as permitted or required by this agreement or as required by law. Business Associate is subject to requirements of the Privacy Rule as by Public Law 111-5, Section 13404 [designated as 42 U.S.C. 17934].
14. Minimum Necessary- LEA (and its agents or subcontractors) shall only request, use and disclose the minimum amount of protected information necessary to accomplish the purpose of the request, use or disclosure, in accordance with the Minimum Necessary requirements of the Privacy Rule including, but not limited to, 45 C.F.R. Sections 164.502(b) and 164.514(d).
15. Notification of Breach- During the term of this MOU, LEA shall notify Benefits Administration within two (2) business days of any suspected or actual breach of security, intrusion or unauthorized use or disclosure of PHI and/or any actual or suspected use or disclosure of data in violation of any applicable federal or state laws or regulations. LEA shall take (i) prompt corrective action to cure any such deficiencies and (ii) any action pertaining to such unauthorized disclosure required by applicable federal and state laws and regulations.
16. This Agreement authorizes and LEA acknowledges and agrees covered entity shall have the right to immediately terminate this agreement and service contracts in the event LEA fails to comply with, or violates a material provision of, requirements of the Privacy and/or Security Rule or this Memorandum. Upon termination of this MOU for any reason, LEA agrees to return or destroy PHI covered by this agreement at the direction of the Covered Entity as required by 45 CFR 164.504(e)(2)(ii)(J).

SECTION 2 - RESPONSIBILITIES OF THE AGENCY BENEFITS COORDINATOR (ABC)

Note: Applicable forms and publications may be found on the PartNers For Health website under the ABC heading.

1. The ABC shall serve as a liaison between the LEA, its employees and BA.
2. During the new employee orientation, the ABC shall:
 - Ensure the employee reviews and signs "Employee Insurance Checklist - Local Education Plan," which shall then be placed in the employee insurance file;
 - Provide to the new employee a TennCare notice and any other notices or information required by the Patient Protection and Affordable Care Act (PPACA), including the federal Marketplace letter;
 - Provide access to the "Benefits Administration Eligibility and Enrollment Guide" for Local Education Employees, HIPAA Notice of Privacy Practices brochure, applicable vendor materials, enrollment forms, any applicable dental and vision handbooks or brochures, provide web address to locate the Summary of Benefits and Coverage tn.gov/partnersforhealth or provide a printed copy if requested, and provide any materials related to new plans of coverage to the new employee;
 - Provide to the employee the deadline to return completed enrollment forms or make their selections online using Employee Self Service (ESS) in Edison;
 - Describe to the eligible employee all available benefits options offered under the Local Education Plan;
 - Ensure the employee receives any new employee orientation materials provided by BA;
 - Explain to the employee the enrollment options including the consequences and next steps if the employee elects not to enroll either self and/or eligible dependents during the initial enrollment period, and how the annual enrollment period works;
 - Identify the effective date of coverage for the employee and any dependents;
 - Describe to the employee how and when to add newly acquired dependents, and explain the

- member's responsibility to provide documentation to verify dependent eligibility;
 - Provide information to employee on premium amounts for all available benefit programs;
 - Specify to the employee how to make changes to coverage or terminate coverage on either self or dependents, including the employee's obligation to immediately notify the ABC and BA of any change in dependent eligibility status;
 - Review with the employee the impact of a leave of absence from employment on benefits;
 - List for the employee the benefits options members have at the time of termination of employment (COBRA, retirement); and
 - Ensure that each new employee is aware of the ParTners For Health Website (as described in item 32 of the Terms and Definitions section of this MOU), the BA Service Center contact information, and the contact information for each vendor
3. All ABCs must participate in monthly/weekly ABC calls with BA staff.
 4. All ABCs must complete any annual mandatory training offered by Benefits Administration. New ABCs, including those who are replacing other ABCs, shall complete initial mandatory training offered by Benefits Administration and may be required to pass a test to get system access. Initial ABC training must be completed within sixty (60) days of becoming a new ABC. Failure to comply with all training requirements will result in suspension of insurance benefits access. Training requirements will not be waived unless approved in advance by BA.
 5. All new ABCs must complete initial HIPAA training module in Edison ELM within thirty (30) days of access to system. All ABCs (primary & backup) must complete the HIPAA training ANNUALLY during the scheduled training month or as otherwise prescribed. ABCs are responsible for enrolling and accessing the HIPAA training in the Edison ELM module. Failure to complete the annually HIPAA training will result in suspension of access to Edison and will not be restored until HIPAA training is complete. There is an instructional video for the training provided on the Partners for Health YouTube channel.
 6. All ABCs shall comply with the procedures set forth in the "ABC Training Presentation - Session I and ABC Training Presentation - Session II" and the "External Agency Calendar" of Edison activities published on the ABC section of the Website as described in item 32 of the Terms and Definitions section of this MOU. Some of these procedures include but are not limited to:
 - Entering into Edison personal and job information for employees;
 - Answering general member questions on benefits and eligibility;
 - Keeping members' addresses and telephone numbers current in Edison; and
 - Downloading reports as necessary via Edison.
 7. The ABC shall refer all eligibility or policy questions related to creditable years of service and monetary retirement benefits to the Tennessee Consolidated Retirement System (TCRS) staff. The ABC shall also be familiar with the various provisions in the "Local Education Plan Document" related to insurance benefits and eligibility for coverage. Questions about retiree eligibility and questions about the annual enrollment period for retirees shall be directed to BA. The ABC is responsible for certifying the Application to Continue Insurance at Retirement.
 8. The ABC shall refer the member to the ParTners For Health website at www.tn.gov/partnersforhealth for information concerning the process for appeals. This information is available in the Member Handbooks, the Summary of Benefits and Coverage and the Plan Document, all of which are posted on the Website.
 9. The ABC shall answer general questions on the coverages offered by the Local Education Plan. The ABC shall refer any detailed eligibility inquiries to the BA Service Center. The ABC shall refer any detailed benefits inquiries to the appropriate insurance carrier.
 10. The ABC shall coordinate or assist with events or benefits fairs related to these products, including reserving meeting space, as requested by BA and ensuring that employees/members are aware of these events.
 11. The ABC shall assist with requests from BA to help with ensuring the agency members respond to

requests for information and otherwise comply with sections "5.04, Subrogation"; "5.05, Right of Reimbursement"; and "5.06, Recovery of Payment" of the Local Education Plan Document.

12. Quarterly, upon request, the ABC shall provide an email address file for all their employees to Benefits Administration within fifteen (15) days of the request.
13. The ABC shall limit the number of administrative error letters submitted. Administrative errors submitted will be reviewed quarterly. An excessive amount of administrative error letters will result in BA contacting the ABC for retraining. The ABC shall lose access to Edison until retraining is completed. The number of errors allowed will be defined and communicated to all agencies based on agency size.
14. The ABC will be required to respond to a yearly audit of ABC security access for their agency. Failure to comply within the time frame given in the audit email communication will result in removal of the agency's access to the Edison system.
15. The ABC will receive quarterly reports from a data match with the NCOA (National Change of Address) database. The ABC shall update addresses in Edison based on the results.
16. The ABC will receive monthly emails on any missing valid Social Security numbers (SSN) for enrolled members. The ABC shall provide the correct SSN to BA by the end of the current month.

SECTION 3 - RESPONSIBILITIES OF BA

1. BA will notify the LEA of any annual premium increase or benefit changes as soon as this information is available.
2. BA, in conjunction with the State of Tennessee Comptroller of the Treasury, will conduct audits to verify that policies and procedures of the Local Education Plan Document are enforced. In addition, BA will conduct reviews of new enrollments to determine if they are eligible for coverage based on Plan Document provisions.
3. BA will publish an up-to-date version of the Plan Document on the ParTNers For Health Website and notify the LEA of any changes.
4. BA will establish and maintain a call center to assist the ABCs and LEA employees in understanding eligibility Plan provisions of, and obtaining benefits under, the Local Education Plan.
5. BA will provide information to the ABCs on the programs offered under the State Group Insurance Program.
6. BA will assist the ABCs with policy, premium and eligibility questions, processing enrollment/change applications and refund issues.
7. BA will provide each LEA with any available new employee orientation materials.
8. BA will provide training for ABCs. BA will refer new ABCs to the "ABC Training Presentation - Session I and ABC Training Presentation - Session II" and will answer questions on using Edison when contacted by ABCs.
9. BA will make available an electronic copy of the "ABC Training Presentation - Session I and ABC Training Presentation Session II" and post a monthly "External Agency Calendar" of scheduled Edison activities on the ParTNers For Health website under the ABC heading.
10. BA will ensure that members have access to an appeals process.
11. BA will administer the continuation of insurance through COBRA.

12. Where appropriate, BA will provide the LEA with information necessary to assist the agency in complying with employer reporting requirements and employee notifications required PPACA.
13. BA will conduct monthly conference calls to provide information and updates. The conference calls will be held weekly leading up to and during the annual enrollment period. Weekly emails will be sent throughout the year to communicate updated information.

Legal Advice: This is a document that binds the signing parties to legally enforceable obligations. BA recommends that you have your legal counsel review this document. BA does not provide legal advice to LEAs and any information that BA provides concerning State or Federal laws is not intended as legal advice.

We understand and agree to abide by the terms and conditions set forth in this document.

LOCAL EDUCATION AGENCY:

Primary ABC (Printed Name/Signature)

Date

Director of Schools (Printed Name/Signature)

Date

Fiscal Officer (Printed Name/Signature)

Date

BENEFITS ADMINISTRATION:

By: Laurie Lee, Executive Director

Signature

Date

PROPOSED FUNDRAISING ACTIVITIES

Fund/account name Girls Softball

Proposed fundraising activities: School Social April 12, 2019

Purposed Uses of funds raised Equipment & Supplies

Expected student involvement (school-wide or specific school organization) _____

Student entrance fees / Concessions

Method by which school will receive profit Student entrance fees / Concessions

Requested by Bryan Anglin / Head Coach
Name/Title

Date 3/18/19

Approved by Ima S. Shug
Principal

Date 3/18/19

Approved by Michelle Hilbert
Director of Schools*

Date 3/18/19

* The Director of Schools must approve all fundraising activities that involve the participation of the general student population in the marketing process of the fundraising effort.

PROPOSED FUNDRAISING ACTIVITIES

Fund/account name Student Council

Proposed fundraising activities: drinks and snack sales

Purposed Uses of funds raised Bulldog Statue

Expected student involvement (school-wide or specific school organization) School Wide

Method by which school will receive profit Charge \$1 per item

Requested by Beth Cooper, Student Council Sponsor Date 3/12/19
Name/Title

Approved by Ima S. Shy Date 3-12-19
Principal

Approved by Michelle Hivent Date 3/18/19
Director of Schools*

* The Director of Schools must approve all fundraising activities that involve the participation of the general student population in the marketing process of the fundraising effort.

PROPOSED FUNDRAISING ACTIVITIES

Fund/account name Student Council

Proposed fundraising activities: Bulldog ~~Statue~~ Talent Show
in May (\$1.00 ~~fee~~ fee to go)

Purposed Uses of funds raised Bulldog Statue

Expected student involvement (school-wide or specific school organization) _____
School Wide

Method by which school will receive profit Charge \$1 per student
to get in.

Requested by Beth Copley Student Date 3/12/19
Name/Title Council
Sponsor

Approved by Ima S. Hug Date 3-12-19
Principal

Approved by Michelle Hewitt Date 3/18/19
Director of Schools*

* The Director of Schools must approve all fundraising activities that involve the participation of the general student population in the marketing process of the fundraising effort.

PROPOSED FUNDRAISING ACTIVITIES

Fund/account name Hickman Co Middle School Football

Proposed fundraising activities: Online Merchandise
KollegeTown / Riddell

Purposed Uses of funds raised
Field Maintenance / Jerseys

Expected student involvement (school-wide or specific school organization) _____
6/7/8 Football

Method by which school will receive profit Check payment

Requested by  Date 2-26-19
Name/Title

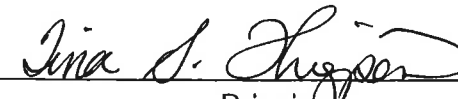
Approved by  Date 2-26-19
Principal

Approved by  Date 2/28/19
Director of Schools*

* The Director of Schools must approve all fundraising activities that involve the participation of the general student population in the marketing process of the fundraising effort.

PROPOSED FUNDRAISING ACTIVITIES

Fund/account name Volleyball HCHS

Proposed fundraising activities: Coed Tournament on April 27, 2019

Purposed Uses of funds raised

Volleyball expenses/uniforms/etc

Expected student involvement (school-wide or specific school organization) _____

mostly ~~referees~~ referees or playing

Method by which school will receive profit each team pays \$60⁰⁰ to participate

Requested by D Brent Bant volleyball coach Date 3/12/19
Name/Title

Approved by [Signature] Date 3/12/19
Principal

Approved by Michelle Gilbert Date 3/12/19
Director of Schools*

* The Director of Schools must approve all fundraising activities that involve the participation of the general student population in the marketing process of the fundraising effort.

PROPOSED FUNDRAISING ACTIVITIES

Fund/account name Class of 2019

Proposed fundraising activities: Sell chocolate bars

Purposed Uses of funds raised

Graduation

Expected student involvement (school-wide or specific school organization) _____

Selected ^{Senior} Students will be involved

Method by which school will receive profit Proceeds from sale

Requested by Melissa Istre, Senior sponsor Date 3/8/19
Name/Title

Approved by [Signature] Date 3/8/19
Principal

Approved by Michelle Hilbert Date 3/12/19
Director of Schools*

* The Director of Schools must approve all fundraising activities that involve the participation of the general student population in the marketing process of the fundraising effort.

PROPOSED FUNDRAISING ACTIVITIES

Fund/account name Football

Proposed fundraising activities: Discount Cards

Purposed Uses of funds raised

Football equipment

Expected student involvement (school-wide or specific school organization) _____

Football team

Method by which school will receive profit selling cards

Requested by Michael Harrison / Head Coach Date 02-27-19
Name/Title

Approved by Ken D. [Signature] Date 2/27/19
Principal

Approved by Michelle Givert Date 2/28/19
Director of Schools*

* The Director of Schools must approve all fundraising activities that involve the participation of the general student population in the marketing process of the fundraising effort.

PROPOSED FUNDRAISING ACTIVITIES

Fund/account name Golf

Proposed fundraising activities: The Drew Golf Scramble

August 24, 2019

Purposed Uses of funds raised (Taking over for Tim + Daphne Luckett)
Golf supplies and equipment, shirts for next year.

Expected student involvement (school-wide or specific school organization) Golf team

Method by which school will receive profit _____

Requested by Craig Shelton Golf Coach Date 2/27/19
Name/Title

Approved by [Signature] Date 2/27/19
Principal

Approved by Michelle Silvert Date 2/28/19
Director of Schools*

* The Director of Schools must approve all fundraising activities that involve the participation of the general student population in the marketing process of the fundraising effort.

PROPOSED FUNDRAISING ACTIVITIES

Fund/account name Cheerleading

Proposed fundraising activities: Yarnel Candle Sale

Purposed Uses of funds raised

offset expenses of uniforms

Expected student involvement (school-wide or specific school organization) _____

Cheerleaders only

Method by which school will receive profit check

Requested by Caryl Moulta
Name/Title

Date 03/19/19

Approved by Eric Camp
Principal

Date 3-19-19

Approved by Michelle Hebert
Director of Schools*

Date 3/20/19

* The Director of Schools must approve all fundraising activities that involve the participation of the general student population in the marketing process of the fundraising effort.

PROPOSED FUNDRAISING ACTIVITIES

Fund/account name 8th-Grade Trip

Proposed fundraising activities: We would like to do a Little Caesars Pizza Kil Fundraiser

Purposed Uses of funds raised The money raised will help to lower the total cost of the 8th-Grade Trip

Expected student involvement (school-wide or specific school organization) 8th-Grade students

Method by which school will receive profit Check or Cash

Requested by Eric Cannon Date 3-4-19
Name/Title

Approved by Eric Cannon Date 3-4-19
Principal

Approved by Michelle Hivet Date 3/5/19
Director of Schools*

* The Director of Schools must approve all fundraising activities that involve the participation of the general student population in the marketing process of the fundraising effort.

PROPOSED FUNDRAISING ACTIVITIES

Fund/account name Football

Proposed fundraising activities: Alumni Football Game
East Hickman vs Fairview (@ Fairview)

Purposed Uses of funds raised
Camp & PIsyers Gear

Expected student involvement (school-wide or specific school organization) _____
School wide Invitation to game

Method by which school will receive profit Gate Money,
People playing in game

Requested by Chris Austin / Head Football Coach Date 3/14/19
Name/Title

Approved by Amber Beem Date 3/14/19
Principal

Approved by Michelle Hebert Date 3/14/19
Director of Schools*

* The Director of Schools must approve all fundraising activities that involve the participation of the general student population in the marketing process of the fundraising effort.

PROPOSED FUNDRAISING ACTIVITIES

Fund/account name Boys Soccer

Proposed fundraising activities: Krispy Kreme Doughnuts

Purposed Uses of funds raised Referee fees

Expected student involvement (school-wide or specific school organization) Team

Method by which school will receive profit Cash & Check

Requested by Wadell Gordon / Coach Date 3-05-19
Name/Title

Approved by Mark A. Bean Date 3-05-19
Principal

Approved by Michelle Gilbert Date 3/5/19
Director of Schools*

* The Director of Schools must approve all fundraising activities that involve the participation of the general student population in the marketing process of the fundraising effort.

PROPOSED FUNDRAISING ACTIVITIES

Fund/account name Cheerleading

Proposed fundraising activities: Krispy Kreme Doughnuts

Purposed Uses of funds raised

camp wear, cheer shoes, transportation cost

Expected student involvement (school-wide or specific school organization) _____

Cheer team

Method by which school will receive profit Cash, check

Requested by Discille Smith, Cheer Coach Date 3-20-19
Name/Title

Approved by Michael Breen Date 3/20/19
Principal

Approved by Michelle Helvert Date 3/20/19
Director of Schools*

* The Director of Schools must approve all fundraising activities that involve the participation of the general student population in the marketing process of the fundraising effort.

PROPOSED FUNDRAISING ACTIVITIES

Fund/account name 703 / Class of 2019

Proposed fundraising activities: Collect \$25 for SR Trip

Purposed Uses of funds raised

Pay for Tickets to HolidayWorld

Expected student involvement (school-wide or specific school organization) 100

(Senior Class only)

Method by which school will receive profit Cash and/or check

Requested by Michy Mathis
Name/Title

Date 3-20-19

Approved by Michael Bean
Principal

Date 3-20-19

Approved by Michelle Helvert
Director of Schools*

Date 3/21/19

* The Director of Schools must approve all fundraising activities that involve the participation of the general student population in the marketing process of the fundraising effort.



East Hickman Elementary School
Staff Report

- We had a very successful Dr. Seuss week which included; family reading night, AR parade, and book fair.
- RTI meetings were held February 26th-27th. We are seeing positive gains with our Tier 2 and 3 students.
- Erase the Stigma Assembly about Bullying was held on Thursday, March 14th for all 1st and 2nd grade students.
- Friday, March 15th EHES hosted our 1st Annual Daddy/Daughter dance. This was held in the gymnasium from 5:30 -7:30. We had over 100 couples in attendance and profited roughly \$2,700.
- Spring Pictures- March 19th-21st.
- Wednesday, March 20th lunch will be provided to our staff by the Women's Prayer Group.
- Wednesday, March 20th, Mrs. Gilbert will be at our school to talk to teachers. This is an opportunity for all staff to speak to Mrs. Gilbert about any concerns or positive things that are happening in our school.
- Spring Break- March 25th-28th.
- Pre-K packets will be available on April 1st.
- Bunny Hop Fundraiser will be held on Friday, April 5th.
- Kindergarten Registration will be April 8th-18th.
- EHES Career Day will be on Friday, April 12th.

Respectfully Submitted,
Leigha Coble
Jim Stone

EHMS Staff Report

Academics

- Our ELA and Math teachers have completed the last round of Benchmark testing. We will use this data to drive our instruction and review when we return from spring break.
- Our 7th and 8th-grade ELA classes will complete our final essay for college readiness writing during the week of March 18th.
- We have completed our online practice using Questar.

Sports

- Our Lady Eagles won their first softball game.
- We will host the district games for softball ball this year.
- Elijah Hamilton has been added to the EHHS Fishing Team. He is an 8th-grader at our school.

School Life

- We plan to complete an AED drill for our spring sports with the help of Kara Hobbs.
- Our Leadership Team continues to work on the planning portion of E-Plan with the help of Katrina Davis.
- Our students will travel to EHHS on March 22nd for the Iguardian training. We would like to give a big thanks to Mrs. Becky Malugin for all of her help to get this line up for our students.
- We are very excited to announce that Ms. Rose Korte will be working with Mrs. Kara Hobbs on a Fuel Up to Play 60 grant.
- Our 8th-graders started their fundraiser to help lower the cost of their trip to Beech Bend Park on May 14th. If you need a Little Ceaser pizza kit, we know where you can buy one.

Centerville Intermediate School March Staff Report

- We have had a busy month at CIS!
- We held parent teacher conferences this month. Conferences included discussions on student grades, progress, and behavior. We always encourage consistent communication with parents and teachers!
- Family Reading and Math Night was March 14th. Our book fair was also open!



- Students the met their AR goals enjoyed a field trip to the bowling alley this month! Students are also working to reach “Millionaire Reader”!



- Attendance continues to be a focus for us. Students that have excessive absences are being addressed through the tier attendance process. We hope to have an attendance challenge in April to emphasize the importance of being at school and learning every day.
- Teacher observations are ongoing. We are hoping to complete all observations before TN Ready testing.
- We recognized our custodians and bus drivers this month with cards and candy. We truly appreciate the work they do for our students every day.
- Teachers will be completing administrator testing training next week and making preparations for TNReady testing. Students will be benchmarking next week.
- We are all working hard to make sure student learning remains our focus at all times. We are looking forward to a great month ahead!



CENTERVILLE ELEMENTARY SCHOOL

Jennifer Hudgins, Principal
(931) 729-2212

104 Mary Field Ave.
Centerville, TN 37033

March 2019 Staff Report

March 7th- Parent-Teacher Conferences, Family Reading Night, and 2nd Grade Quiz Bowl

March 8th- RTI Meetings

March 12th & 13th- Jennifer Hudgins and Cary Wright attending TELN Convening

March 14th- Parent Teacher Conference (Day 2)

March 15th- Jennifer Hudgins attended Principal Pipeline Training

March 20- Stacia Anglin and Dee Yablonski visited the Centerville Dayschool to read to students

March 21st- Leadership Meeting

March 22nd- PBS Day