

Board of Education Regular Meeting

May 27, 2025 6:00 PM

City Hall Council Chambers

I. CALL TO ORDER Procedural Item	Chair Butch Campbell
A. Pledge of Allegiance Procedural Item The Pledge of Allegiance will be led by Monroe Brown, a Kindergarten student and his sister, Piper Brown, a 2nd grade student at Salem Elementary, and Connor Key, Gabe Pritchard, and Elijah Pena, all students at Scales Elementary.	
B. Moment of Silence Procedural Item	
II. APPROVAL OF AGENDA Action Item	Chair Butch Campbell
III. COMMUNICATIONS Information Item Our schools had a great Teacher Appreciation Week thanks to the many community partners that treated their staff. Reeves-Rogers would like to specifically thank First Baptist on Castle, St. Marks Methodist Church, Redstone Credit Union, and The Experience Community for lunch. ESP summer registration including camp information is now open. Go to the ESP website for full details The CHOW bus will begin on June 2 and continue until August 1. Full site and scheduled is on the website. The Mobile Resource Van will be following the CHOW bus on scheduled days during the summer. Kindercamp is scheduled for the week of July 21 for incoming kindergarten students who are registered for school. It's a week long camp through ESP that offers our youngest students a glimpse at their new school environment. Thank you to Fellowship and New Vision for their incredible work on our backpack food program throughout this past year. Cason Lane Pre-K would like to thank the owners of Lemongrass Sushi & Thai Restaurant (also known as Laila's parents) for providing lunch for all of us!	Mrs. Lisa Trail
A. The Best of MCS-David Philippee, 6th grade student at Black Fox-National Invention Convention Candidate Procedural Item	Dr. Trey Duke
B. Spotlight on Education: STEAM Designation for John Pittard Representing John Pittard Dr. Christy Robinson-Principal Jessica Jacobs -Assistant Principal	Dr. Trey Duke

<p>Sarah Easterly- Academic Coach Sasha Burnette- Art Educator Rebekah Tate-2nd Grade Teacher Spring Harris- 1st Grade Teacher Luke Hill- STEAM/Music Teacher</p> <p>STEAM Designation for Discovery School</p> <p>Representing Discovery School Julie Seymour-Educational Assistant/STEAM Lab Shea Payne-4th Grade Teacher Dr. Caitlin Bullard-Principal</p> <p>Math Competition Winners:</p> <p>4th Grade Individual: Aubrey Griffin-Discovery School Noelle Campbell-Discovery School Dylan Neese-Northfield Elementary</p> <p>4th Grade Team-Discovery School</p> <p>5th Grade Individual: Easton Clementi-Mitchell Neilson Elementary Jillian Wyrick-Overall Creek Elementary Phoenix Mallard-Reeves Rogers Elementary Mina Smith-Salem Elementary</p> <p>5th Grade Team-Discovery School Procedural Item</p>	
<p>C. Public Comment Procedural Item</p>	Chair Butch Campbell
<p>IV. CONSENT ITEMS Consent Agenda</p>	Chair Butch Campbell
<p>A. Approval of 5-7-25 County Commission/Board Meeting and 5-13-25 Board Meeting Minutes Consent Item</p>	
<p>B. Personnel Report Consent Item</p>	
<p>C. Approval of Contract-Bus Recertifications Consent Item</p>	
<p>D. Approval of Contract-Upland Software Consent Item</p>	
<p>E. Approval of Contract-Titan Material (Forklift for 910) Consent Item</p>	
<p>F. Approval of Surplus Property Disposal Consent Item</p>	
<p>V. ACTION ITEMS Action Item</p>	Chair Butch Campbell
<p>A. Approval of Board Policy 6.401, Student Health Services, on First Reading Action Item</p>	Ms. Lauren Bush
<p>B. Approval of Budget Amendment-Summer School Action Item</p>	Dr. Trey Duke
<p>C. Approval of Budget Amendment-21st Century Grant</p>	Dr. Trey Duke

Action Item	
D. Approval of Budget Amendment-Nutrition Action Item	Dr. Trey Duke
E. Approval of Contract-Board Recommendation for Read to Succeed Lease Action Item	Dr. Trey Duke
F. Approval of Agreement with Finalsity-Mass Notification Services Action Item	Dr. Trey Duke
G. Approval of Agreement with BJB Construction for Interior Painting at Discovery School Action Item	Dr. Trey Duke
H. Approval of Agreement CMG Contractors for Interior Painting at Hobgood Elementary School Action Item	Dr. Trey Duke
I. Board Recommendation of Zone Appeal Hearing Number 1 Action Item	Mr. Ken Rocha
J. Board Recommendation of Zone Appeal Hearing Number 2 Action Item	Mr. Ken Rocha
K. Board Recommendation of Zone Appeal Hearing Number 3 Action Item	Mr. Ken Rocha
L. Approval of Revenue and Expenditure Report Action Item	Mr. Daniel Owens
VI. REPORTS AND INFORMATION Information Item	Chair Butch Campbell
A. Enrollment (PTR) Report Action Item	Mr. Ken Rocha
B. City Schools Foundation Update Information Item	Ms. Lisa Trail
C. Director's Update Information Item	Dr. Trey Duke
VII. OTHER BUSINESS Information Item	Chair Butch Campbell
A. Distribution of Director's Evaluation Information Item	Ms. Lauren Bush
VIII. ADJOURNMENT Action Item	Chair Butch Campbell

MINUTES

Board of Education Meeting w/County Commissioners

May 7, 2025 6:00 PM

MCS Administrative Offices

<p>I. CALL TO ORDER Procedural Item In attendance: Chair Butch Campbell, Vice Chair Amanda Moore, Ms. Barbara Long, Dr. Trey Duke, Daniel Owens, Lauren Bush, Lisa Trail, County Commissioner Jeff Phillips (District 17), County Commissioner Phil Dodd (District 16), Commissioner Robert Peay (District 4), and Michael Smith, Finance Director for the County Government.</p>	Chair Butch Campbell
<p>II. WELCOME AND INTRODUCTIONS Procedural Item Chairman Campbell welcomed the group and asked everyone to introduce themselves.</p>	Chair Butch Campbell
<p>III. GOAL OF THE MEETING Procedural Item Ms. Moore explained the purpose and goal of the meeting. She told the Commissioners that actions of the commission affect City Schools, and the Board felt that they had not had the ability in the past to talk about how these choices were affecting our district. The Board asked that we invite the County Commissioners that represent the City of Murfreesboro to this meeting to try and ensure there is a common understanding of the effects of the decisions that have been made over the past three years.</p>	Vice Chair Amanda Moore
<p>IV. DISCUSSION Procedural Item Dr. Duke shared data illustrating the financial impact of the reallocated penny on the city school system over the past three years and the culminating impact Mr. Smith suggested that additional funding requests should be directed to the city government rather than the county and indicated that a further, modest reallocation may occur this year. Commissioner Dodd said that he would take this information to his constituents but feels that the moving of pennies may be the new norm. Commissioner Peay said that this is not only impacting the city school system, but rural areas in the county as well. He suggested advocating with the state legislators for the county to have the ability to enact an impact fee to generate revenue. Additional discussion around the topic was had. Dr. Duke emphasized the goal of this meeting was to ensure they had the information on the impact to their constituents in Murfreesboro City Schools. Further updates will be discussed at the next board meeting on May 13th.</p>	Dr. Trey Duke
<p>V. ADJOURNMENT Action Item Chairman Butch Campbell made the motion to adjourn, and Vice Chair Amanda Moore seconded the motion. The meeting adjourned at 7:16 pm.</p>	Chair Butch Campbell

Director of Schools

Board of Education Regular Meeting

May 13, 2025 6:00 PM

MCS Administrative Offices

<p>I. CALL TO ORDER Procedural Item Present: Mr. Butch Campbell, Ms. Karen Dodd, Ms. Barbara Long, Ms. Amanda Moore, Mrs. Jeanette Price, Mr. David Settles, Absent: Mr. Jimmy Richardson III. In attendance: Dr. Trey Duke, Daniel Owens, Sheri Arnette, Angela Fairchild, Lisa Trail, Ken Rocha, Don Bartch, Maria Johnson, Jaci Saunders, Emily Spencer Assistant City Attorney Lauren Bush and City Liaison Bill Shacklett</p>	Chair Butch Campbell
<p>A. Pledge of Allegiance Procedural Item The Pledge of Allegiance will be led by Board Chairman, Mr. Butch Campbell.</p>	
<p>B. Moment of Silence Procedural Item</p>	
<p>II. APPROVAL OF AGENDA Action Item Motion to approve the agenda. This motion, made by Ms. Amanda Moore and seconded by Mr. Butch Campbell, passed. Yea: 6, Nay: 0, Absent: 1 Motion to approve the agenda adding the Summer School Budget. This motion, made by Ms. Amanda Moore and seconded by Mr. Butch Campbell, passed. Yea: 6, Nay: 0, Absent: 1</p>	Chair Butch Campbell
<p>III. CONSENT ITEMS Consent Agenda Motion to approve consent agenda. This motion, made by Mrs. Jeanette Price and seconded by Ms. Karen Dodd, passed. Yea: 6, Nay: 0, Absent: 1</p>	Chair Butch Campbell
<p>A. Approval of 4-29-25 Board Minutes Consent Item</p>	
<p>B. Approval of 2025-2026 Job Descriptions Consent Item</p>	
<p>i. Job Description-BEST Coordinator Consent Item</p>	
<p>ii. Job Description-Intervention and Learning Loss Specialist Consent Item</p>	
<p>iii. Job Description-School Nutrition Maintenance Consent Item</p>	
<p>C. Approval of Contract-Zaner Bloser K and 1 Handwriting Consent Item</p>	
<p>D. Approval of Surplus Property Disposal Consent Item</p>	
<p>IV. PUBLIC COMMENT Procedural Item</p>	Chair Butch Campbell
<p>V. ACTION ITEMS Action Item</p>	Chair Butch Campbell
<p>A. Approval of 21st CCLC Budget Revision Action Item</p>	Dr. Trey Duke

<p>Motion to approve the 21st CCLC Budget Revision. This motion, made by Ms. Barbara Long and seconded by Ms. Karen Dodd, passed. Yea: 6, Nay: 0, Absent: 1</p>	
<p>B. Budget Amendment-FY25 Consolidated Funding Application Action Item Motion to approve Budget Amendment-FY25 Consolidated Funding Application. This motion, made by Ms. Amanda Moore and seconded by Ms. Barbara Long, passed. Yea: 6, Nay: 0, Absent: 1</p>	Dr. Trey Duke
<p>C. Budget Amendment-FY25 Extended School Program (ESP) Action Item Motion to approve Budget Amendment-FY25 Extended School Program (ESP). This motion, made by Ms. Karen Dodd and seconded by Mr. David Settles, passed. Yea: 6, Nay: 0, Absent: 1</p>	Dr. Trey Duke
<p>D. Budget Amendment-FY25 General Purpose Budget Action Item Motion to approve Budget Amendment-FY25 General Purpose Budget. This motion, made by Mr. David Settles and seconded by Mrs. Jeanette Price, passed. Yea: 6, Nay: 0, Absent: 1</p>	Dr. Trey Duke
<p>E. Budget Amendment-FY25 New Revenue General Purpose Budget Action Item Motion to approve Budget Amendment-FY25 New Revenue General Purpose Budget. This motion, made by Ms. Barbara Long and seconded by Ms. Amanda Moore, passed. Yea: 6, Nay: 0, Absent: 1</p>	Dr. Trey Duke
<p>F. Budget Amendment-FY25 School Nutrition Budget Action Item Motion to approve Budget Amendment-FY25 School Nutrition Budget. This motion, made by Ms. Karen Dodd and seconded by Mr. David Settles, passed. Yea: 6, Nay: 0, Absent: 1</p>	Dr. Trey Duke
<p>G. Approval of Public Service Bond for the Director Action Item Motion to approve the Public Service Bond for the Director. This motion, made by Mr. David Settles and seconded by Mrs. Jeanette Price, passed. Yea: 6, Nay: 0, Absent: 1</p>	Dr. Trey Duke
<p>H. Approval of the Disciplinary Hearing Authority (Board Policy 6.317) Action Item Motion to approve the Disciplinary Hearing Authority (Board Policy 6.317). This motion, made by Mr. David Settles and seconded by Ms. Barbara Long, passed. Yea: 6, Nay: 0, Absent: 1</p>	Dr. Trey Duke
<p>I. Approval of Contract-RCLS Interlocal Agreement (Donating a Bus) Action Item Motion to approve Contract-RCLS Interlocal Agreement (Donating a Bus). This motion, made by Mr. David Settles and seconded by Ms. Karen Dodd, passed. Yea: 6, Nay: 0, Absent: 1 Amanda Moore asked how we have a surplus bus. Don Bartch explained that we have buses that are non-operational due to state requirements around mileage and years of service,. The district's intent was to surplus, but Rutherford County felt that they could repair the bus for what they need it for. Dr. Duke explained that this bus had aged out of our system and there had not been students on this bus in a while.</p>	Dr. Trey Duke
<p>J. Approval of Contract-Genesis Learning Centers Services for 2025-2026 Action Item Motion to approve the Contract-Genesis Learning Centers Services for 2025-2026. This motion, made by Mr. David Settles and seconded by Ms. Karen Dodd, passed.</p>	Dr. Trey Duke

<p>Yea: 6, Nay: 0, Absent: 1 Lauren Bush explained that the price increase from last year is the only change to this contract.</p> <p>David Settles asked if Genesis operates Rutherford Academy and Angela Fairchild said yes.</p> <p>Angela Fairchild said that this is more of a therapeutic placement and we have seven students in Genesis this year. Dr. Duke said that it requires parent approval. He said that Melissa Snyder in the Sped department goes with parents and gives them a tour. These students are counted in our enrollment numbers.</p> <p>Barbara Long asked if the cost of Genesis is per student, per day and Angela said yes.</p> <p>Daniel Owens said that last year we budgeted 40,000 but we went over. Karen Dodd asked how much we went over. Daniel said that he would get that information back to the Board.</p>	
<p>K. Approval of Contract-Sourcewell Agreement for Cook's Direct Nutrition Steamer Purchase Action Item Motion to approve the Contract-Genesis Learning Centers Services for 2025-2026. This motion, made by Ms. Amanda Moore and seconded by Mrs. Jeanette Price, passed. Yea: 6, Nay: 0, Absent: 1</p>	Dr. Trey Duke
<p>L. Approval of the 2025-26 Summer School Budget Action Item Motion to approve the 2025-2026 Summer School Budget. This motion, made by Ms. Barbara Long and seconded by Mr. David Settles, passed. Yea: 6, Nay: 0, Absent: 1 Mrs. Arnette gave a quick update on summer school. She told the Board that currently we have over 1200 students registered. She said that this is the 2nd largest enrollment since the first year of summer school. She said that teachers are placed, and rosters are complete, and everyone is ready to go. Summer School will be held at six locations.</p>	Dr. Trey Duke
<p>VI. REPORTS AND INFORMATION Information Item</p>	Chair Butch Campbell
<p>A. Results of the TSBA Board Self-Assessment Information Item</p>	Dr. Trey Duke
<p>B. 2025-2026 Board Meeting Dates Information Item Dr. Duke shared the 2025-2026 Board Calendar dates with the Board and explained that the calendar was very similar to this year with meetings being held at central office as well as city hall.</p> <p>Barbara Long asked if that was a hindrance to the public for us to hold meetings here at central office. Dr. Duke said that all meetings are open to the public and he has not heard any complaints about the meetings being here at central office.</p> <p>David Settles said that he appreciates the meetings being at both locations and felt that it is probably more convenient for central office staff.</p> <p>There were no changes to the proposed calendar.</p>	Dr. Trey Duke
<p>C. Director's Update Information Item In the Director's Update, Dr. Duke said that we have 10 days of school left and it has been a great year! He said that we will be coming back after Memorial Day. He said that some have</p>	Dr. Trey Duke

<p>asked about having to come back after Labor Day, but he reminds them that the Teacher Advisory Council helps to develop the calendar and the trade off to that is having the week of Thanksgiving off. Dr. Duke added that summer school will begin on June 2.</p> <p>He said that he and his staff are working through the timeline for the end of the year assessment, and will begin retesting students on May 22nd.</p> <p>We will be doing zooms tomorrow for 3rd and 4th grade. Mrs. Ortiz will do the Spanish zoom next week. He said that in the past, we have been able to find promotion pathways for every students so if they were retained, it was at the request of the parent. He feels confident that we will do the same this year.</p> <p>Dr. Duke provided information on Federal Funding. He added notes in red to the document to help understand programs that were being eliminated. He said that we are still a long way from congress approving a budget, but hoped that this would help clarify some things as far as the Federal Programs.</p> <p>He said that Title IA would have level funding. He added that we have had level funding for three years in that program. His concern with level funding is that it will pay for fewer educators in the future. He wanted to provide this document so that the Board would know that we are watching these programs closely.</p> <p>Barbara Long asked about Nutrition and if that would be affected. Dr. Duke explained that Nutrition is funded through the USDA and not out of the Department of Education and should not be affected. Jaci Saunders said that the only thing that has been affected was Farm to School Grants.</p>	
<p>VII. OTHER BUSINESS Information Item</p>	<p>Chair Butch Campbell</p>
<p>VIII. ADJOURNMENT Action Item Motion to adjourn at 6:41. This motion, made by Mr. David Settles and seconded by Ms. Karen Dodd, passed. Yea: 6, Nay: 0, Absent: 1 Meeting adjourned at 6:42 p.m. with the Board going into a Closed Executive Session.</p>	<p>Chair Butch Campbell</p>
<p>IX. CLOSED EXECUTIVE SESSION Procedural Item</p>	<p>Dr. Trey Duke</p>

Director of Schools

Human Resources Personnel Report 04/21/2025 - 5/22/2025

Certified Hires

none to report

Certified Interims

none to report

Classified New Hires

<u>Last Name</u>	<u>First Name</u>	<u>Start Date</u>	<u>Location</u>	<u>Position</u>	<u>Notes</u>
Alhassan	Rana	4/21/2025	MNS	SPED EA	SUB TO EA
Smith	Howard	5/6/2025	SHOP	Bus Assistant	

Certified Resignations/Retirements/Terminations/ Etc.

<u>Last Name</u>	<u>First Name</u>	<u>Last Day</u>	<u>Location</u>	<u>Position</u>	<u>Tenure Y/N</u>
Harvey-Kindred	Jennifer	4/25/2025	CLAPK	IPK Teacher	N
Whinery	Jeremy	5/5/2025	MNS	SPED BEST Teacher	N

Classified Resignations/Retirements/Terminations/Etc.

<u>Last Name</u>	<u>First Name</u>	<u>Last Day</u>	<u>Location</u>	<u>Position</u>
Taylor	Glen	4/22/2025	ESE	Calm Coach EA
Payne	Misti	4/22/2025	JP	Caf. Assistant Manager
Sorrells	Kathryn	4/28/2025	ESP	Little Sprouts Asst. Teacher
Olsen	Roxann	5/9/2025	DS	SPED EA
Lincoln	Jessica	5/14/2025	NF	Pre-K EA
Bailey	Carl	5/14/2025	SHOP	Bus Assistant
Collins	Emma	5/21/2025	MNS	Mental Health Clinician

Agenda Item Title: Request for Extended Utilization of School Buses

Board Meeting Date: May 27, 2025

Department: Operations

Presented by: Don Bartch

Board Agenda Category:

Consent Agenda

Action Item

Reports and Information

Requires City Council Approval: Yes No

Summary

Pursuant to TCA 49-6-2109 and State Board of Education Rule 0520-01-05-.01(4), Type C and D school buses may continue to be used after fifteen years of service, subject to approval by the Board of Education and the Commissioner of Safety and additional safety inspections by the State of Tennessee. The district currently owns a total of 12 buses that are eligible for extended utilization, with four due for payment. These buses have reached the 15-year threshold but remain in good operating condition and have passed or are expected to pass inspection by the Tennessee Department of Safety.

Staff Recommendation

Approve Request for Extended Utilization of School Buses

Fiscal Impact

Each extended utilization costs \$770 per year for two required inspections. By extending the use of the 15 buses, the district will defer the purchase of new buses estimated at \$175,000.00 each.

Connection to MCS's Five-Year Strategic Plan

- Known:** Every student will be *known* through whole-child programs and support.
- Safe:** Every student will be *safe* through equitable access to buildings, facilities, and infrastructure that meets their needs.
- Challenged:** Every student will be *challenged* by learning from highly effective educators and employees.
- Empowered:** Every student will be *empowered* through academic success



TENNESSEE DEPARTMENT OF SAFETY & HOMELAND SECURITY
Tennessee Highway Patrol – Pupil Transportation Division
 Davis Quad 3, 1228 Foster Avenue
 Nashville, Tennessee 37243
 Phone: 615-743-4990, option 3
 Fax: 615-253-2280

\$385
566

RECEIVED

JAN 21 2025

1062500234 1/21/25

Bus 566

ACCOUNTS PAYABLE
REQUEST FOR EXTENDED UTILIZATION OF SCHOOL BUS

In accordance with the provisions of T.C.A. 49-6-2109, I am requesting authorization to use the following vehicle on a regular route basis for the 2024 -- 2025 school year.

TYPE C OR D SCHOOL BUSES WITH FIFTEEN OR MORE YEARS OF SERVICE

Vehicle Identification Number	Model Year	Mileage	Make	Date Placed In Service
4DRBWAAR49A115777	2009	143271	IC Bus	10/2008

As the owner of the above documented vehicle, I am responsible to ensure that a second inspection as required in T.C.A. § 49-6-2109 is completed no later than 6 months from the initial inspection listed below.

Request Date: 01/08/2025 Bus Owner: MURFREESBORO CITY Phone Number: (615) 898-7126

Payment must be remitted to: Cashier's Office, PO Box 24589, Nashville, TN 37202

Payment of **\$385** for each inspection or **\$770** for a complete year must be received 60 days prior to each inspection (2 inspections per year required). A separate form should be completed for each bus being requested.

This payment is being remitted for: Year of Service: 17th 1st Inspection 2nd Inspection

Commissioner or Designee _____ Date: _____

Internal Use Only

Vehicle Mileage _____ School System of Use _____

Vehicle Maintenance Files requested and reviewed:

Yes _____ No, Explanation _____



TENNESSEE DEPARTMENT OF SAFETY & HOMELAND SECURITY

Tennessee Highway Patrol – Pupil Transportation Division

Davis Quad 3, 1228 Foster Avenue

Nashville, Tennessee 37243

Phone: 615-743-4990, option 3

Fax: 615-253-2280

\$385
575

1062500234
1/21/25 Bus 575

RECEIVED

JAN 21 2025

ACCOUNTS
PAYABLE

REQUEST FOR EXTENDED UTILIZATION OF SCHOOL BUS

In accordance with the provisions of T.C.A. 49-6-2109, I am requesting authorization to use the following vehicle on a regular route basis for the 2024 -- 2025 school year.

TYPE C OR D SCHOOL BUSES WITH FIFTEEN OR MORE YEARS OF SERVICE

Vehicle Identification Number	Model Year	Mileage	Make	Date Placed In Service
1T7YU4E29B1135227	2011	150156	Thomas Built Bus	02/2010

As the owner of the above documented vehicle, I am responsible to ensure that a second inspection as required in T.C.A. § 49-6-2109 is completed no later than 6 months from the initial inspection listed below.

Request Date: 01/08/2025 Bus Owner: MURFREESBORO CITY Phone Number: (615) 898-7126

Payment must be remitted to: Cashier's Office, PO Box 24589, Nashville, TN 37202

Payment of **\$385** for each inspection or **\$770** for a complete year must be received 60 days prior to each inspection (2 inspections per year required). A separate form should be completed for each bus being requested.

This payment is being remitted for: Year of Service: 16th 1st Inspection 2nd Inspection

Commissioner or Designee _____ Date: _____

Internal Use Only

Vehicle Mileage _____ School System of Use _____

Vehicle Maintenance Files requested and reviewed:

Yes _____ No, Explanation _____

Agenda Item Title: Upland Software for Filebound Software Services

Board Meeting Date: May 27, 2025

Department: Student Supports

Presented by: Ken Rocha

Board Agenda Category:

Consent Agenda

Action Item

Reports and Information

Requires City Council Approval: Yes No

Summary

This one-year contract with Upland Software provides continued access to our current digital student record keeping system. The system complies with all state laws and regulations. This contract is for one year because the Tennessee Department of Education is in the process of reviewing Student Information Systems, which may include student digital records features.

Staff Recommendation

Approve Agreement with Upland Software for Filebound Software Services

Fiscal Impact

The cost of the one-year contract is \$36,066.36 and is included in our FY26 general-purpose budget.

Connection to MCS's Five-Year Strategic Plan

- Known:** Every student will be *known* through whole-child programs and support.
- Safe:** Every student will be *safe* through equitable access to buildings, facilities, and infrastructure that meets their needs.
- Challenged:** Every student will be *challenged* by learning from highly effective educators and employees.
- Empowered:** Every student will be *empowered* through academic success

ADDENDUM TO UPLAND SOFTWARE MASTER SERVICES AGREEMENT

This Addendum (herein "Addendum") amends the Master Services Agreement, and all attachments, exhibits, any physical or virtual documents or writings, referenced therein, and any click through, clickwrap, shrink-wrap, or other such virtual agreement (all of which are herein "Agreement") between Upland Software and its Affiliates (herein "Contractor") and Murfreesboro City Schools (herein "District," or "Customer"). In consideration of using Contractor's form agreement, the mutual promises set out herein, and other good and valuable consideration, the sufficiency of which is hereby acknowledged the Agreement is amended as follows:

1. **Precedence.** Notwithstanding any other provision in the Agreement, the language in this Addendum takes precedence over all other terms, conditions, or language to the contrary or in conflict with the language herein, and the Agreement and this Addendum shall not be construed to create any ambiguity, it being the intent of the parties that this Addendum shall control.
2. **Indemnity, Limitation of Liability and Disclaimer of Warranty.** Article II, Section 29 of the Tennessee Constitution prohibits cities from lending their credit to private entities and, therefore, prohibits an agreement by Customer to indemnify a third party or agree to a limitation of liability provision. Any indemnity or hold harmless provision contained in the Agreement requiring Customer to indemnify or hold harmless Contractor or any other person or entity and any limitation of liability in favor of Contractor is deleted. No provision of this Agreement shall act or be deemed a waiver by Customer of any immunity, including its rights or privileges afforded by the Tennessee Constitution or state law including but not limited to any provision of the Tennessee Governmental Tort Liability Act, T.C.A. section 29-20-101 et seq. Because Tennessee law may not allow Customer to agree to the disclaimer of warranties any such disclaimer of warranties shall be enforceable only to the extent permitted by Tennessee law, and Customer reserves all rights afforded to local governments under law for all general and implied warranties.
3. **Confidentiality.** The Agreement is a public record, and it, along with all documents or materials, in any format, including, but not limited to, paper, electronic, or virtual, that are public records pursuant to the Tennessee Open Records Act, set out in T.C.A. §10-7-503 et seq., are not confidential and are subject to disclosure in whole or in part, without regard to any provision contained in the Agreement declaring information confidential. Additionally, Customer must, upon proper request, release public documents and records as defined by T.C.A. §10-7-503 et seq., including, but not limited to, the Agreement and all records created and maintained related to the Agreement, without any requirement to disclose such request to Contractor or provide Contractor with notice or the time to obtain a protective order. Customer does not have the burden of establishing that information is not confidential information or that its release is authorized to release the records. This section 3 serves to meet such burden and authorization of disclosure.
4. **Termination for Convenience.** District or Contractor may terminate the Agreement and use

of the service at any time for any reason. However, termination shall not take effect until sixty (60) days after written notice is delivered by the party terminating the agreement to the other party. Such termination will not be deemed a breach of contract by either party. Upon such termination, Contractor will not have any right to any actual general, special, incidental, consequential, or any other damages whatsoever of any description or amount. Notices to the Customer shall be sent to:

Director of Schools
Murfreesboro City Schools
2552 South Church Street
Murfreesboro, TN 37127

5. **Governing Law.** The Agreement and the rights and obligations of the parties are governed by the laws of the state of Tennessee, without regard to its conflict of laws principles.
6. **Selection of Jurisdiction, Waiver of Jury Trial, Venue, Service of Process.** Pursuant to the Constitution and Laws of the State of Tennessee, Customer is a sovereign entity subject only to those courts with jurisdiction over District. If a dispute arises between the parties concerning any aspect of the Agreement, and it cannot be resolved by mutual agreement, any party may resort to resolution of the dispute by litigation in the state courts in Murfreesboro, Tennessee, or the Federal court for the Middle District of Tennessee. However, neither party shall be obligated to provide any type of pre-suit notice before initiating a cause of action. The parties waive their right to a jury trial. The parties hereby consent to the mandatory and exclusive venue and jurisdiction of the state court located in Murfreesboro, Tennessee, or the Federal court for the Middle District of Tennessee. Service of process on Customer shall comply with the Tennessee Rules of Civil Procedure or applicable federal rules, and Customer does not agree to any other service of process procedure.
7. **Responsibility for Litigation Costs, Expenses and Payment of Attorney's Fees.** Article II, Section 29 of the Tennessee Constitution prohibits cities from lending their credit to private entities and, therefore, prohibits an agreement by Customer to indemnify a third party or agree to a limitation of liability provision. This prohibition extends to contractual provisions for the payment of attorney's fees. In the event of litigation between Customer and Contractor each party shall be solely and exclusively responsible for the payment of litigation costs, expenses and attorney's fees excepting those costs which may be awarded by a court of competent jurisdiction as specified by Tennessee law or applicable rules of civil procedure.
8. **Non-appropriation.** Contractor acknowledges that Customer is a governmental entity, and the validity of the Agreement is based upon the availability of public funding under its authority. In the event Client fails to appropriate funds or make monies available for any fiscal year covered by the term of this Agreement for the services to be provided, this Agreement shall be terminated on the last day of the fiscal year for which funds were appropriated or monies made available for such purposes without liability to District, such termination shall not be a breach of this Agreement, and any unused payment made to Contractor shall be returned to District. Furthermore, this provision shall extend to any and all obligations imposed upon Customer to reimburse Contractor for any reimbursements, refunds, chargebacks, penalties, fees, or other financial obligations which exceed the funds tendered to Contractor, FPPs, or Payment

Processing Partners in relation to any event.

9. **No Taxes.** As a tax-exempt entity, Customer shall not be responsible for sales or use taxes incurred for products or services. Customer shall supply Contractor with its Sales and Use Tax Exemption Certificate upon Contractor's request.
10. **Warranty.** Contractor warrants that the products purchased herein when used in accordance with the documentation shall operate in all material respects in conformity with the written representations of Contractor. If it does not perform as warranted, Contractor shall use commercially reasonable efforts to correct the products so that it operates in all material respects in conformity with the written representations of Contractor. If it cannot correct the products within a reasonable period of time, Contractor shall refund the purchase price of the products.
11. **Amendment.** This Addendum and the Agreement shall not be modified or altered other than by written agreement executed by both parties.
12. **Survival.** This Addendum shall survive the completion of or any termination of the Agreement or other document which may accompany the Agreement or be incorporated by reference.
13. **No Presumption Against Drafter.** This Addendum shall not be construed for or against any party because that party or that party's legal representative drafted any of its provisions. Accordingly, this Addendum shall be construed without regard to the rule that ambiguities in a document are to be construed against the draftsman. No inferences shall be drawn from the fact that the final, duly executed Addendum differs in any respect from any previous draft hereof.
14. **Counterparts.** This Addendum may be executed in one or more counterparts by Customer and Contractor. If so executed, the signer shall deliver an original to the other party and the collective counterparts shall be treated as the fully executed document.
15. **Effective Date.** This Addendum shall be effective immediately after the Agreement is effective.

SIGNATURE PAGE FOLLOWS

Upland Software

Murfreesboro City Schools

Signature

Bobby N. Duke, III
Director of Schools

Date

Date

Printed Name

Title

Approved as to form:

Lauren Bush, Assistant City Attorney

Upland Software, Inc.
 401 Congress Ave Suite 1850 Austin
 TX
 78701-3788
 United States
 Phone:855-944-PLAN (7526)
www.uplandsoftware.com

Quote Number: Q-358561-3
Quote Date: 3/10/2025
Quote Expires On: 6/30/2025
Proposed By: Paul Cinquegrana
Email: pcinquegrana@uplandsoftware.com

Customer and Billing Details

Customer: Murfreesboro City School District
Customer Number: C-21044
Ship To: Murfreesboro City School District
 2552 S Church St.
 Murfreesboro , TN , 37127
 United States
Bill To: Murfreesboro City School District
 2552 S Church Street
 Murfreesboro , TN , 37127-7135
 United States
Primary Contact: April Zavisa
Primary Phone: (615) 893-2313
Billing Currency: USD

Purchase Details

Start Date: 7/1/2025 **End Date:** 6/30/2026 **Product Billing Frequency:** Annual
Payment Terms: Due on Receipt

License and Product Details

Description	Billing Frequency	Quantity Unit of Measure	Net Unit Price	Term (Months)	Annual Amount	Extended Price for Full Term
FileBound: FileBound Capture Subscription - included with subscription	Annual	10 Each	\$ 0.00	12.00	\$ 0.00	\$ 0.00
FileBound: Importer Pro Subscription - included with subscription	Annual	1 Each	\$ 0.00	12.00	\$ 0.00	\$ 0.00
FileBound: Other Maintenance	Annual	1 Unit per Year	\$ 20,321.28	12.00	\$ 20,321.28	\$ 20,321.28
FileBound: Setup, Cloud Site Setup - 1,000,000 Enterprise	Annual	1 Unit per Month	\$ 621.51	12.00	\$ 7,458.08	\$ 7,458.08
Upland PSP (Plus)	Annual	1 Unit per Year	\$ 5,464.60	12.00	\$ 5,464.60	\$ 5,464.60
Upland PSP Health Check	Annual	6 Hours	\$ 0.00	12.00	\$ 0.00	\$ 0.00
FileBound: Importer Pro - Subscription	Annual	1 Unit per Month	\$ 235.20	12.00	\$ 2,822.40	\$ 2,822.40
Total:					\$ 36,066.36	\$ 36,066.36

Quote Total Amount

Total:	USD 36,066.36
---------------	---------------

Upland Software, Inc.
401 Congress Ave Suite 1850 Austin
TX
78701-3788
United States
Phone:855-944-PLAN (7526)
www.uplandsoftware.com

Quote Number: Q-358561-3
Quote Date: 3/10/2025
Quote Expires On: 6/30/2025
Proposed By: Paul Cinquegrana
Email: pcinquegrana@uplandsoftware.com

Terms and Conditions

- Binding Effect.** Customer and Upland are entering into this sales order or quote ("Sales Order") subject to the terms of the Master Services Agreement ("MSA") currently in effect between the parties as of the date this Sales Order is signed (this Sales Order together with the MSA, the "Agreement"). In the event there is no MSA currently in effect, then the applicable terms and conditions of the Master Services Agreement hosted at <http://www.uplandsoftware.com/terms-of-service.pdf> shall control. Capitalized terms not defined in this Sales Order have the meaning ascribed to them elsewhere in the Agreement.
- Non-Waiver.** For record-keeping purposes and the convenience of its Customers, in advance of the expiry of this Sales Order Upland may provide Customer with an updated Sales Order detailing the Services to be supplied by Upland upon renewal. For the avoidance of doubt, the parties acknowledge and agree that Upland's provision of such an updated Sales Order shall not constitute Upland's notice of (i) its intention not to renew the Agreement, or (ii) its intention to terminate the Agreement.
- Fees.** Customer agrees to pay any and all fees provided herein. Prices quoted are exclusive of any applicable taxes. All subscription fees hereunder shall be invoiced in advance and are due and payable in accordance with the Payment Terms set forth above. Customer acknowledges that fees for renewal periods shall be invoiced in advance and are due on or before the start date of such renewal period.
- Professional Services Fees.** Fees prepaid for Professional Services become non-refundable and are earned upon the earlier of: (i) the date the Professional Services are delivered (on a *pro-rata*, ongoing basis); or (ii) one year from the date of the applicable invoice. Any Professional Services purchased but not yet delivered as of the End Date set forth above shall be deemed to have expired effective as of the End Date. If no End Date is set forth, then such Professional Services shall expire one year after the signature date of this Sales Order Form. Additional specifics governing expiration may be outlined in the accompanying Statement of Work, if available. In the event of any conflict between the terms of this Sales Order Form and any accompanying Statement of Work, the terms of the Statement of Work shall control and prevail, and the terms of this Sales Order shall be of no effect.

Upland Software, Inc.
401 Congress Ave Suite 1850 Austin
TX
78701-3788
United States
Phone:855-944-PLAN (7526)
www.uplandsoftware.com

Quote Number: Q-358561-3
Quote Date: 3/10/2025
Quote Expires On: 6/30/2025
Proposed By: Paul Cinquegrana
Email: pcinquegrana@uplandsoftware.com

BY AFFIXING THE SIGNATURE OF THE AUTHORIZED REPRESENTATIVE OF THE CUSTOMER TO THIS QUOTE, BY HAND OR ELECTRONICALLY, CUSTOMER IS AGREEING TO BE BOUND BY THE TERMS OF THE AGREEMENT

Name (Print): _____ Date: _____

Title: _____ Signature: _____

Customer: Murfreesboro City School District

If a Purchase Order is required for the purchase or payment of the items on this Sales Order, please complete the following:

PO Number: *\PO_Number1*

PO Amount: *\PO_Amount1*

Upland Signature

Name (Print): _____ Date: _____

Title: _____ Signature: _____

THANK YOU FOR YOUR BUSINESS!

Upland Software, Inc.
 401 Congress Ave Suite 1850 Austin
 TX
 78701-3788
 United States
 Phone:855-944-PLAN (7526)
www.uplandsoftware.com

Quote Number: Q-358561-3
Quote Date: 3/10/2025
Quote Expires On: 6/30/2025
Proposed By: Paul Cinquegrana
Email: pcinquegrana@uplandsoftware.com

Please verify and initial the following customer information and indicate what needs to be changed, if needed.

Customer Checklist			
Checklist Item	Response		If there are changes, please provide details below.
Does your company require a PO# on invoices? If yes, please provide PO# in the space by signature block.	Yes cb1_one\ No cb1_one\ 	Initial ln1_two\ 	txtSp1_one\
Are the company name and billing address correct?	Yes cb1_two\ No cb1_two\ 	Initial ln1_two\ 	txt1_two\
Does your company need Upland to fill out a supplier form to properly set Upland up as a vendor? This includes setting up supplier portals.	Yes cb1_three\ No cb1_three\ 	Initial ln1_two\ 	txt1_three\
Is your company a tax-exempt entity? If Yes, please provide the associated tax certificate.	Yes cb1_four\ No cb1_four\ 	Initial ln1_two\ 	txt1_four\

Agenda Item Title: Purchase of Forklift from Titan Material Handling

Board Meeting Date: May 27, 2025

Department: Operations

Presented by: Don Bartch

Board Agenda Category:

Consent Agenda

Action Item

Reports and Information

Requires City Council Approval: Yes No

Summary

MCS is seeking Board approval for the purchase of a new forklift to support warehouse operations at 910 Ridgley Rd. The purchase aligns with long-term logistical planning and supports the continued functionality of the warehouse. Funding for the purchase has been identified within the approved budget for facilities and operations.

Staff Recommendation

Approve Purchase of Forklift from Titan Material Handling

Fiscal Impact

The total cost of the forklift is \$18,000.00 and will be funded through the General-Purpose budget.

Connection to MCS's Five-Year Strategic Plan

- Known:** Every student will be *known* through whole-child programs and support.
- Safe:** Every student will be *safe* through equitable access to buildings, facilities, and infrastructure that meets their needs.
- Challenged:** Every student will be *challenged* by learning from highly effective educators and employees.
- Empowered:** Every student will be *empowered* through academic success

**CONTRACT BETWEEN
MURFREESBORO CITY SCHOOLS
AND
TITAN MATERIAL HANDLING, INC.
FOR PURCHASE OF CPYD25C 2022 HELI FORKLIFT**

This Contract is entered into and effective as of the ____ day of May 2025, by and between the **Murfreesboro City Schools**, a municipal school district of the State of Tennessee ("District") and **Titan Material Handling, Inc.**, a for-profit corporation in the State of Tennessee ("Contractor").

This Contract consists of the following documents:

- *This Contract;*
- *Contractor's Quote #050825-AM2 (the "Price Proposal");*
- *Any properly executed amendments to this Agreement.*

In the event of conflicting provisions, all documents shall be construed according to the following priorities:

- *First, any properly executed amendment or change order to this Contract (most recent amendment or change order given first priority);*
- *Second, this Contract;*
- *Finally, Contractor's Quote #050825-AM2 (the "Price Proposal").*

1. **Duties and Responsibilities of Contractor.** Contractor agrees to provide, and District agrees to purchase: One (1) Used Model CPYD25C 2022 Forklift as set forth in Quote 050825-AM2, described as follows:
 - 2022 Used/Current Titan Rental Fleet 5,000 LB Capacity, LP/Gas Powered, HELI Forklift
 - Model # CPYD25C
2. **Term.** The Contract shall be a one-time purchase and the term shall expire upon acceptance of and payment for vehicle by the District.
3. **Termination.** Contractor's performance may be terminated in whole or in part:
 - a. Upon thirty (30)-day prior notice, for the convenience of the District.
 - b. For the convenience of Contractor, provided that Contractor notifies the District in writing of its intent to terminate under this paragraph at least thirty (30) days prior to the effective date of the termination.
 - c. For cause, by either party where the other party fails in any material way to perform its obligations under this Agreement. Termination under this subsection is subject to the condition that the terminating party notifies the other party of its intent to terminate, stating with reasonable specificity the grounds therefore, and the other party fails to remedy the problem within fifteen (15) days after receiving the notice.
 - d. Should Contractor fail to fulfill in a timely and proper manner its obligations under this Agreement or if it should violate any of the terms of this Agreement, the District

has the right to immediately terminate the Agreement. Such termination does not relieve Contractor of any liability to the District for damages sustained by virtue of any breach by Contractor.

- e. Should the appropriation for Contractor’s work be withdrawn or modified, the District has the right to terminate the Agreement immediately upon written notice to Contractor.
4. **Price.** The price for goods and other items to be provided under this Contract is set forth per the Quote 050825-AM2 for a Used/Current Titan Rental Fleet 5,000 LB Capacity, LP/Gas Powered, HELI Forklift for a **Total Purchase Price of eighteen thousand dollars and zero cents (\$18,000.00)**. Any compensation due Contractor under this Agreement shall be made upon submittal of an invoice after delivery and acceptance of the goods which each payment represents. The District agrees to pay Contractor after goods have been received, accepted, and properly invoiced as indicated in the Contract and/or purchase order.
5. **Warranty.** Warranties are as stated in the attached Quote 050825-AM2.
6. **Indemnification.**
- a. Contractor must indemnify, defend, and hold harmless the District, its officers, agents and employees from any claims, penalties, damages, costs and attorney fees (“Expenses”) arising from injuries or damages resulting from, in part or in whole, the negligent or intentional acts or omissions of contractor, its officers, employees and/or agents, including its subcontractors or independent contractors, in connection with the performance of this Agreement, and, expenses arising from any failure of Contractor, its officers, employees and/or agents, including its subcontractors or independent contractors, to observe applicable laws, including, but not limited to, labor laws and minimum wage laws.
 - b. Pursuant to Tennessee Attorney General Opinion 93-01, the District will not indemnify, defend or hold harmless in any fashion Contractor from any claims arising from any failure, regardless of any language in any attachment or other document that Contractor may provide.
7. **Notices.** Notice of assignment of any rights to money due to Contractor under this Contract must be mailed first class mail or hand delivered to the following:

If to Murfreesboro City Schools:

Murfreesboro City Schools
Attn: Finance Director
2552 South Church Street
Murfreesboro, TN 37127

If to the Contractor:

Amanda Mukai
651 Middle Tennessee Blvd., Suite C
Murfreesboro, TN 37129

8. **Taxes.** Murfreesboro City Schools is exempt from State sales tax and will issue a tax exemption certificate to the Contractor as requested. District shall not be responsible for any taxes that are

imposed on Contractor. Furthermore, Contractor understands that it cannot claim exemption from taxes by virtue of any exemption that is provided to District.

9. **Compliance with Laws.** The parties agree to comply with any applicable federal, state and local laws and regulations.
10. **Maintenance of Records.** Contractor shall maintain documentation for all charges against District. The books, records, and documents of Contractor, insofar as they relate to work performed or money received under the contract, shall be maintained for a period of three (3) full years from the date of final payment and will be subject to audit, at any reasonable time and upon reasonable notice by District or its duly appointed representatives. The records shall be maintained in accordance with the Generally Accepted Accounting Principles.
11. **Modification.** This Contract may be modified only by written amendment executed by all parties and their signatories hereto.
12. **Relationship of the Parties.** Nothing herein may in any way be construed or intended to create a partnership or joint venture between the parties or to create the relationship of principal and agent between or among any of the parties. None of the parties hereto may hold itself out in a manner contrary to the terms of this paragraph. No party becomes liable for any representation, act, or omission of any other party contrary to this section.
13. **Waiver.** No waiver of any provision of this contract shall affect the right of any party thereafter to enforce such provision or to exercise any right or remedy available to it in the event of any other default.
14. **Employment.** Contractor shall not subscribe to any personnel policy which permits or allows for the promotion, demotion, employment, dismissal or laying-off of any individual due to race, creed, color, national origin, age, sex, veteran status, or any other status or class protected under federal or state law or which is in violation of applicable laws concerning the employment of individuals with disabilities.
15. **Non-Discrimination.** It is the policy of the District not to discriminate on the basis of age, race, sex, color, national origin, veteran status, disability, or other status or class protected under federal or state law in its hiring and employment practices, or in admission to, access to, or operation of its programs, services, and activities. With regard to all aspects of this Agreement, Contractor certifies and warrants it will comply with this policy. No person may be excluded from participation in, be denied benefits of, be discriminated against in the admission or access to, or be discriminated against in treatment or employment in the District's contracted programs or activities, on the grounds of handicap and/or disability, age, race, color, religion, sex, national origin, or any other classification protected by federal or Tennessee State Constitutional or statutory law; nor may they be excluded from participation in, be denied benefits of, or be otherwise subjected to discrimination in the performance of contracts with the District or in the employment practices of the District's Contractors.
16. **Gratuities and Kickbacks.** It is a breach of ethical standards for any person to offer, give or agree to give any employee or former employee, or for any employee or former employee to solicit, demand, accept or agree to accept from another person, a gratuity or an offer of employment in connection with any decision, approval, disapproval, recommendation, preparation of any part of a program requirement or a purchase request, influencing the content of any specification or procurement standard, rendering of advice, investigation, auditing or in

any other advisory capacity in any proceeding or application, request for ruling, determination, claim or controversy or other particular matter, pertaining to any program requirement of a contract or subcontract or to any solicitation or proposal therewith. It is a breach of ethical standards for any payment, gratuity or offer of employment to be made by or on behalf of a subcontractor under a contract to the prime contractor or higher tier subcontractor or a person associated therewith, as an inducement for the award of a subcontract or order. Breach of the provisions of this paragraph is, in addition to a breach of this Agreement, a breach of ethical standards which may result in civil or criminal sanction and/or debarment or suspension from being a contractor or subcontractor under the District contracts.

17. **Assignment**. The provisions of this Agreement inure to the benefit of and are binding upon the respective successors and assignees of the parties hereto. Except for the rights of money due to Contractor under this Agreement, neither this Agreement nor any of the rights and obligations of Contractor hereunder may be assigned or transferred in whole or in part without the prior written consent of the District. Any such assignment or transfer does not release Contractor from its obligations hereunder
18. **Integration**. This Contract and State contract set forth the entire agreement between the parties with respect to the subject matter hereof and govern the respective duties and obligations of the parties.
19. **Force Majeure**. No party has any liability to the other hereunder by reason of any delay or failure to perform any obligation or covenant if the delay or failure to perform is occasioned by force majeure, meaning any act of God, storm, fire, casualty, unanticipated work stoppage, strike, lockout, labor dispute, civil disturbance, riot, war, national emergency, act of public enemy, epidemic, pandemic or other cause of similar or dissimilar nature beyond its control.
20. **Governing Law and Venue**. The validity, construction and effect of this Agreement and any and all extensions or modifications thereof are governed by the laws of the state of Tennessee regardless of choice of law doctrine or provision in any attachment or other document that Contractor may provide. Any action between the parties arising from this agreement may only be filed in the courts of Rutherford County, Tennessee.
21. **Severability**. Should any provision of this contract be declared to be invalid by any court of competent jurisdiction, such provision shall be severed and shall not affect the validity of the remaining provisions of this contract.
22. **Attorney Fees**. In the event any party takes legal action to enforce any provision of the Agreement, should the District prevail, Contractor will pay all expenses of such action including attorney fees, expenses, and costs at all stages of the litigation and dispute resolution
23. **Effective Date**. This Contract shall not be binding upon the parties until signed by each of the Contractor and authorized representatives of the District and is thereafter effective as of the date set forth above.

SIGNATURE PAGE FOLLOWS

IN WITNESS WHEREOF, the parties enter into this agreement as of the “Effective Date” first listed above.

MURFREESBORO CITY SCHOOLS

TITAN MATERIAL HANDLING, INC.

By: _____
Bobby N. Duke, III
Director of Schools

By: _____

APPROVED AS TO FORM:

Lauren Bush, Assistant City Attorney



Adam Grisz
 Murfreesboro City Schools
 2552 South Church St
 Murfreesboro, TN 37127
 615-225-9352
 Adam.grisz@cityschools.net

Amanda Mukai
 651 Middle TN BLVD, Suite C
 Murfreesboro, TN 37129
amanda@TitanMH.com
 1-615-924-1592
 Quote #050825-AM2

Cost Quote (1) Used/Current Titan Rental Fleet **5,000 LB Capacity**, LP/Gas Powered, HELI Forklift



Model: CPYD25C



Model Year: 2022

Low Hours: 3,800 hours (Average per year single shift operation is 2000 hours)

Capacity: 5,000 LB

LP/Gas Powered Forklift

Mast: Triple Stage, Lift Height 185-inches

Attachment: Hang on Sideshifter, (moves load side to side)

Forks: 42 inch length forks

Tires: Solid Rubber Tires

LED Front Lights, Combination Rear Lights, Rear View Mirror, Back Up Alarm, Load Backrest,

Overhead Guard, Steering Wheel, Knob, LED Amber Strobe Light, Turn Signals (front & back)

Full Suspension Seat with Seat Belt, Back Up Reverse Handle with Horn Button

Warranty: 6 month powertrain warranty (engine/transmission)

Used In stock 5,000 LB Capacity LP/Gas Forklift Cost: \$18,000.00 each

Availability: In Stock Now Current Titan Rental Fleet Forklift

Terms: Check upon delivery of forklift, sales tax not included, if tax exempt, no sales tax added to invoice

Free Delivery Local Delivery, Middle Tennessee location, normally takes about 1 week to get lift ready

Approval Signature

PO#

Date

Agenda Item Title: Approval of Surplus Items

Board Meeting Date: May 27, 2025

Department: Finance and School Operations

Presented by: Trey Duke, Director of Schools

Board Agenda Category:

- Consent Agenda
 - Action Item
 - Reports and Information
-

Summary

Board policy 2.403 defines surplus property as property no longer having an intended use by the school district and/or no longer capable of being used because of the property's condition. Policy 2.403 requires the Director of Schools/designee to prepare a list of unusable items for Board approval.

These items have been deemed surplus items and will be either sold or discarded based on board policy.

Staff Recommendation

Recommending approval of the surplus of the items specified within this packet.

Fiscal Impact

All unusable items shall be sold to the highest bidder after advertising in a newspaper of general circulation and online at least seven (7) days prior to the sale. Surplus property which has no value or has a value of less than five hundred dollars (\$500) may be disposed of without the necessity of bids pending appropriate approvals.

Connection to MCS's Five-Year Strategic Plan

- Known:** Every student will be *known* through whole-child programs and support.
- Safe:** Every student will be *safe* through equitable access to buildings, facilities, and infrastructure that meets their needs.
- Challenged:** Every student will be *challenged* by learning from highly effective educators and employees.
- Empowered:** Every student will be *empowered* through academic success

Dena Thomas

From: Don Bartch
Sent: Monday, May 19, 2025 8:03 AM
To: Larry Willeford; Dena Thomas
Cc: Brandon Richardson
Subject: Re: Woodshop Dust Collection System

Thank you, Larry.

Dena, can we please put this up after we get the surplus. We really don't need to wait until school begins to post this one, as it will be part of the move.

Thanks,

Don Bartch
Assistant Superintendent of School Operations
Murfreesboro City Schools

2552 South Church Street
Murfreesboro, TN 37127
Office: 615-893-2313 ext. 10083
Cell: 615-785-6360

From: Larry Willeford <Larry.Willeford@cityschools.net>
Sent: Saturday, May 17, 2025 11:03 AM
To: Dena Thomas <Dena.Thomas@cityschools.net>
Cc: Brandon Richardson <Brandon.Richardson@cityschools.net>; Don Bartch <Don.Bartch@cityschools.net>
Subject: Woodshop Dust Collection System

In the attached and the reference pictures below is information regarding our woodshop dust collection system at 710 New Salem that I would like to put on GovDeals since we no longer will be building casework out of the 910 building. In your narrative when posting, please make sure to note this is a 3 phase 230/460 volt system. Note that all the electrical components are included with the system. If you have any questions on the information I have provided..... please let me know.

Thanks,

Larry Willeford
Maintenance Supervisor
Murfreesboro City Schools

615.904.1016 Office

615.482.3957 Cell
615.848.3077 Fax

From: Larry Willeford <Larry.Willeford@cityschools.net>
Sent: Thursday, May 15, 2025 10:55 AM
To: Larry Willeford <Larry.Willeford@cityschools.net>
Subject:

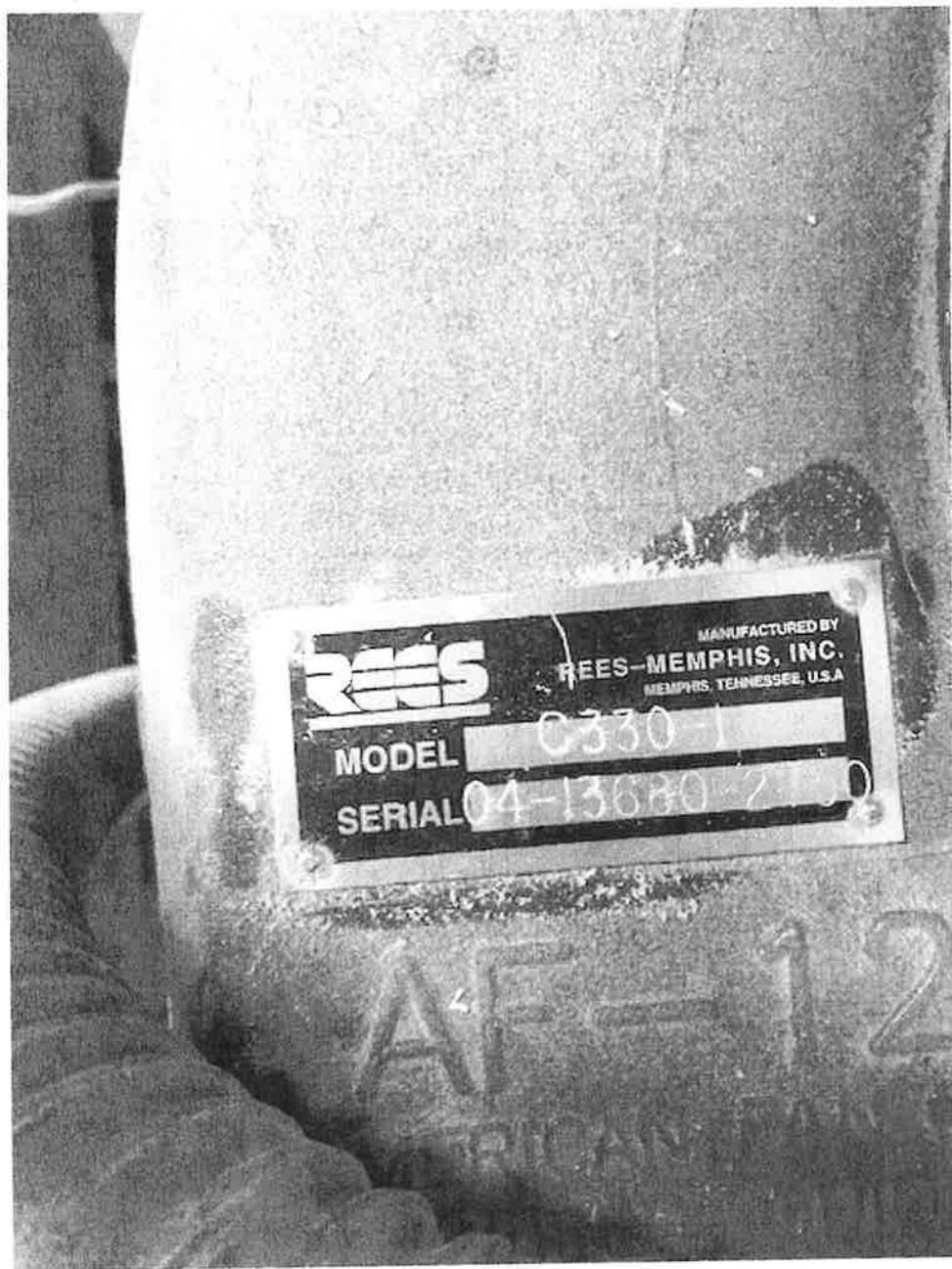

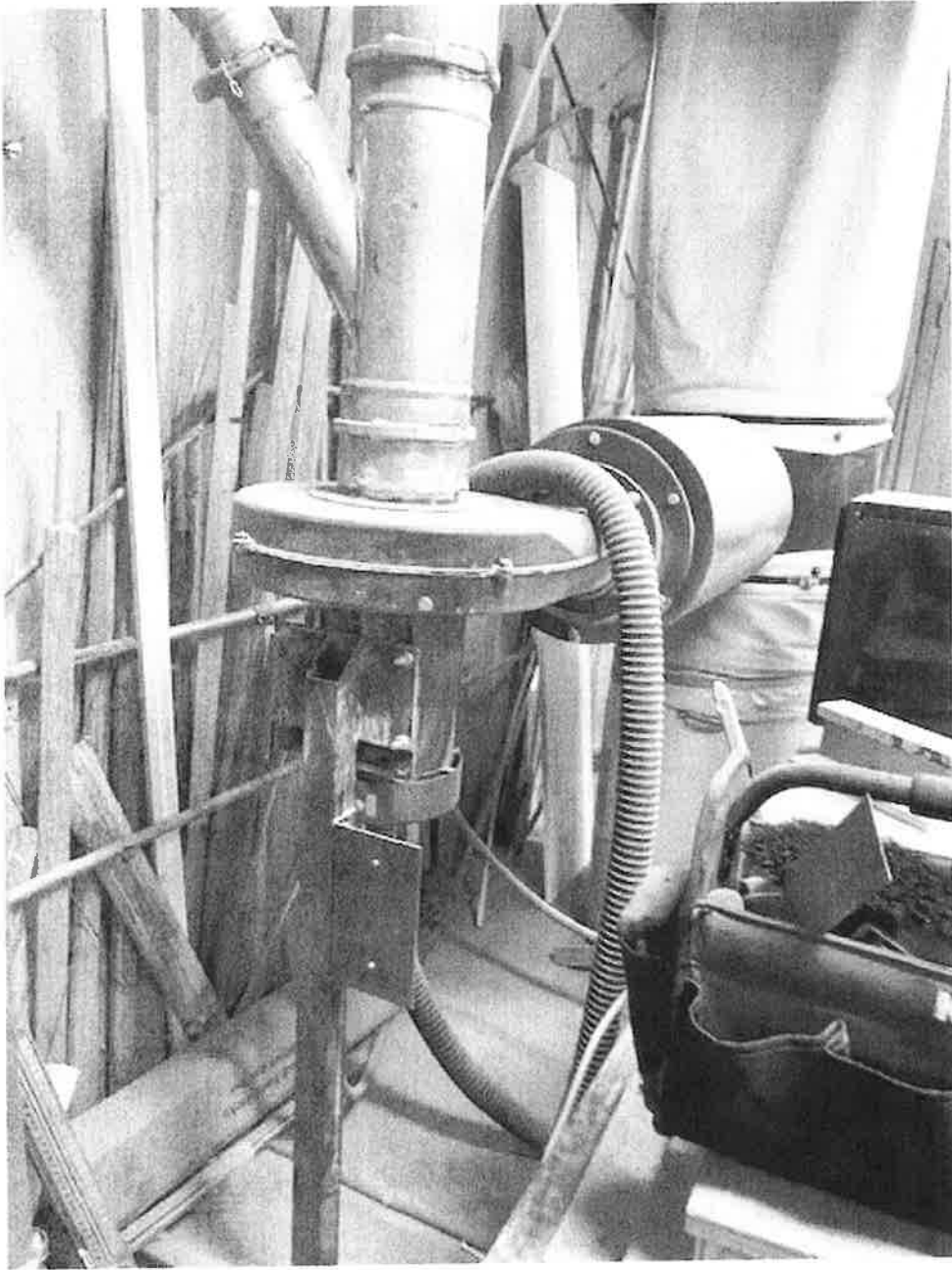



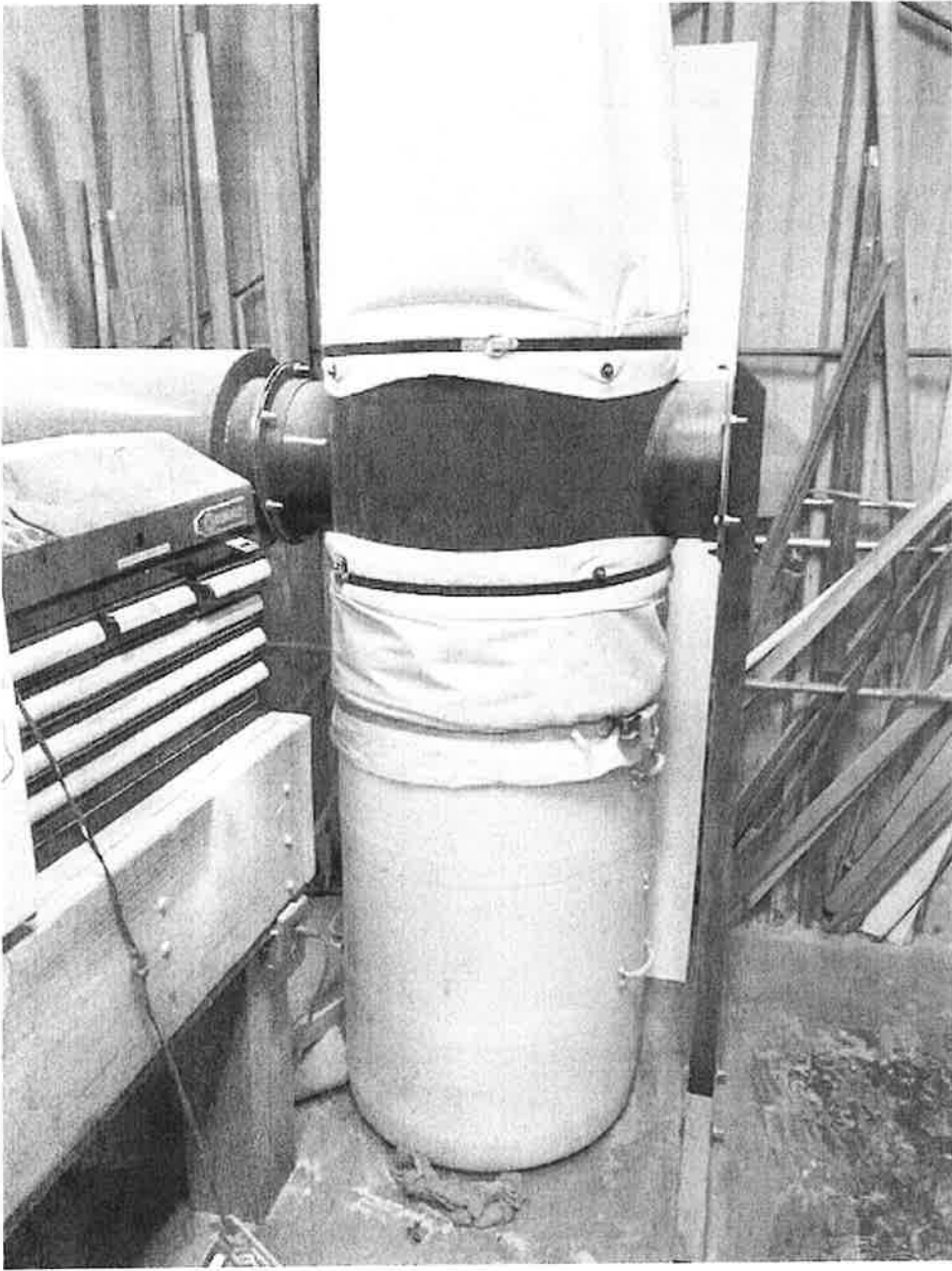

Sent from my iPhone

Model C Dust Collectors

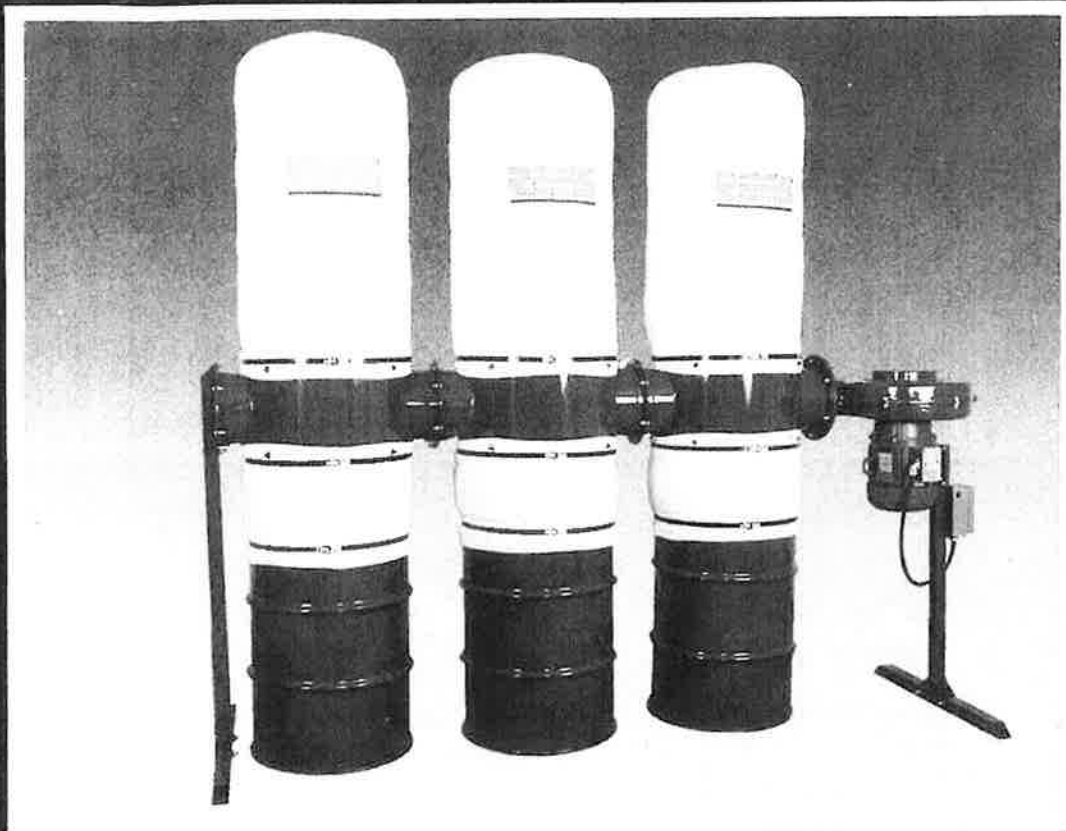

Features

Many Applications

The REES Model C Dust Collectors can be used on many types of equipment where dust is a problem. These units efficiently collect dust from operations such as wood, plastics, food products, rubber, paper and textiles.

Quality Construction

REES Dust Collectors are heavy duty, compact, and built to last. Heavy gauge steel and continuous welds are manufacturing standards and all bolted parts use 3/8" dia. bolts.

Efficient Operation

REES Dust Collectors are designed to efficiently separate particles from dust laden air. Dust passes through the fan and into the collector modules. An air deflector in each module initiates the separating process. The heavier particles drop to the storage container and clean in-plant air is returned to the manufacturing area.

Flexible Design

Choose from five different CFM capacities to suit your particular application. REES Model C Dust Collectors are available in 2HP, 3HP, 5HP, 7½ HP and 10 HP sizes with 1 to 8 collector modules. The modular design allows you to add on in the future to increase filter area and storage capacity. For waste storage, this collector uses 55-gallon drums, plastic bags or cloth bags for more initial filter area.

Easy Installation

Each unit is shipped with collector modules, filter bags, motorized fan, and miscellaneous parts for complete assembly. All components bolt together easily with hand tools.

Simple Maintenance

Maintenance involves a periodic shaking of the upper filter bags to knock dust particles from the inside wall and emptying of the storage drums or lower bags as required.

REES

Dust Collection / Steel Fabrication

Specifications

Blower Unit

2 HP, 3 HP, 5 HP and 7.5 HP units use 3 phase, 208 - 230/460 volt, 3450 RPM, TEFC, direct drive motors. Single phase available in 2 HP, 3 HP, and 5 HP models. The 10 HP unit uses a 3 phase, 208 - 230/460 volt 1750 RPM, TEFC motor with v-belt drive. 10 HP floor mounted fan includes elbow and splitter fittings to connect to collector modules.

Collector Module

Each collector module is manufactured with continuous welds and heavy gauge steel. It includes an air deflector and connecting flanges with 3/8" diameter bolts.

Quick Release Clamps

Adjustable steel band clamps are furnished with spring loaded clasp.

Filter Bag and Sleeve

A polyester sateen 7.5 oz./sq. yd. filter media is used with mounting grommets, support rods, and band clamps. The filter sleeve is used for the drum connection. The cloth area is 25 sq. ft. per bag and 7 sq. ft. per sleeve.

Waste Storage

55 gallon drums, filter bags, or plastic bags may be used for waste storage. (Customer to furnish 55 gallon drums.)

Leg Supports

2" square tubing provides extra support and stability. 3/8" diameter bolts are included for easy assembly.

Model	HP	PH	Modules	Storage Capacity (Ft. ³)	Filter Area (Ft. ²)	Inlet Dia. N	Length L	Width W	Height H	Shipping Weight (Lbs.)
C 210-1	2	1	1	8.2	32	6"	4'2"	3'0"	8'3"	245
C 210-2	2	1	2	16.4	64	6"	6'7"	3'0"	8'3"	305
C 230-1	2	3	1	8.2	32	6"	4'2"	3'0"	8'3"	245
C 230-2	2	3	2	16.4	64	6"	6'7"	3'0"	8'3"	305
C 310-1	3	1	1	8.2	32	7"	4'3"	3'0"	8'3"	275
C 310-2	3	1	2	16.4	64	7"	6'8"	3'0"	8'3"	335
C 310-3	3	1	3	24.6	96	7"	9'1"	3'0"	8'3"	395
C 330-1	3	3	1	8.2	32	7"	4'3"	3'0"	8'3"	275
C 330-2	3	3	2	16.4	64	7"	6'8"	3'0"	8'3"	335
C 330-3	3	3	3	24.6	96	7"	9'1"	3'0"	8'3"	395
C 510-2	5	1	2	16.4	64	8"	6'11"	3'0"	8'3"	355
C 510-3	5	1	3	24.6	96	8"	9'4"	3'0"	8'3"	415
C 510-4	5	1	4	32.8	128	8"	11'9"	3'0"	8'3"	475
C 530-2	5	3	2	16.4	64	8"	6'11"	3'0"	8'3"	355
C 530-3	5	3	3	24.6	96	8"	9'4"	3'0"	8'3"	415
C 530-4	5	3	4	32.8	128	8"	11'9"	3'0"	8'3"	475
C 730-3	7.5	3	3	24.6	96	10"	9'4"	3'0"	8'3"	455
C 730-4	7.5	3	4	32.8	128	10"	11'9"	3'0"	8'3"	515
C 1030-4	10	3	4	32.8	128	11"	10'0"	4'6"	8'3"	780
C 1030-6	10	3	6	49.2	192	11"	12'6"	4'6"	8'3"	900
C 1030-8	10	3	8	65.6	256	11"	15'0"	4'6"	8'3"	1020

Options

Silencer

REES Collectors are rated at 88 DBA, depending on pipe design and shop layout. A silencer may be ordered which bolts easily between the fan and collector. It adds 2'6" to the length of the dust collector and cuts noise by an average of 8 DBA.

P-B Starter

Manual push-button starter with overload protection may be ordered. Motor leg is equipped with starter mounting plate (standard). 10 HP 208-230 volt models use larger magnetic starter.

Large Filter Bags

Large filter bags may be ordered instead of standard 25 sq. ft. bags when conditions involve smaller dust particles. The 40 sq. ft. bag increases the filter area by 60% and the height to 10'9". The 55 sq. ft. bag increases the filter area by 120% and the height to 13'3".



Dust Collection/Steel Fabrication

(901) 774-8830 FAX (901) 774-5000

REES-MEMPHIS, INC. / 2426 Channel Avenue
P. O. BOX 13225 / Memphis, Tennessee 38113-0225

Performance

SERIES	HP	STATIC PRESSURE* vs. CFM					
		5"	6"	7"	8"	9"	10"
200	2	780	731	678	612	536	436
300	3	1333	1217	1075	982	920	861
500	5	1895	1772	1653	1542	1442	1325
700	7.5	2542	2457	2382	2258	2045	1840
1000	10	—	4168	3852	3515	3170	2809

*NOTE static pressure is measured as total external in inches water gauge.

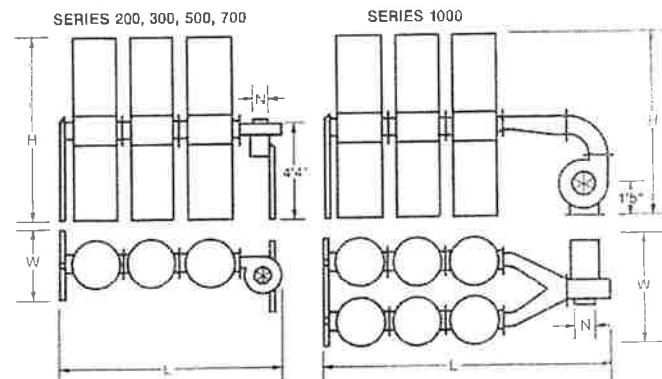

Distributed By

**Clamp down
on high installation costs.**

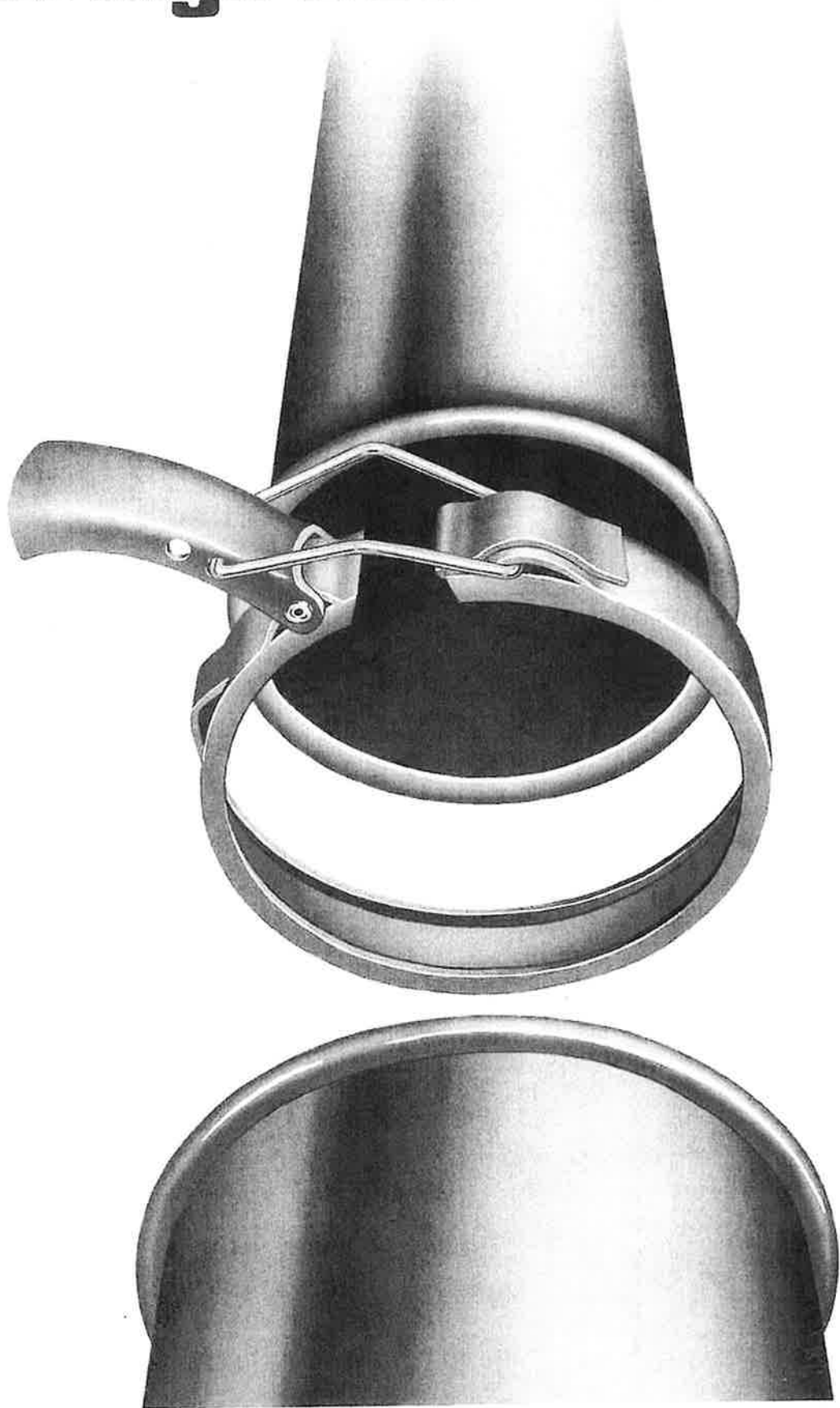

America's premier clamp-together duct system.

Quick-Fit puts the squeeze on costly conventional duct installation.

Q-F is a snap! No complicated cutting, no riveting, no braising or welding as required for a conventional duct installation. One Q-F clamp connects sections together in seconds. Branches, diverters, elbows, all adapt easily to your existing duct and may be taken apart and re-used without special tools.

Q-F is easy to install, easy to align, and it's strong.

Q-F clamps are so easy to install, they *almost* install themselves. Employees simply place the clamp over the Q-F rolled lip ends and snap! The extra strength of the Q-F connection provides a solid, straight run. Q-F parts are created with specially machined double-rolled lips for added strength. The patented Q-F clamp connects the rolled ends. Snap the Q-F clamp and you have the strongest, safest, re-usable dust-extraction piping available today. No special instructions or trades are needed to assemble a Q-F system. Install new lines, clean out lines or make changes to existing duct runs *anytime* it's needed with Q-F.

Q-F adapts to your every need; connect to the old or bring in the new.

Q-F has everything you need in galvanized or stainless steel parts:

- 4" to 22" diameter pipe
- branch fittings of all sizes and shapes
- elbows 30°, 45°, 60°, 90°
- larger custom sizes and special adapters

All are available with 4 to 5 day delivery.

Q-F adjusts to fit: without complicated measurements.

Planning to add, remove, or replace dust-extraction piping? Q-F's adjustable fitting slides together to create the precise length. No need for time wasted on exact measuring and precision cuts; simply slide on and fit to your desired length, a few inches or a few feet. Need a different length for a new run? Simply re-use your Q-F components and re-fit; that again reduces cutting and fabricating time.

Q-F saves you time and money. No other company in America delivers like Q-F.

Just how much money can you save using Q-F? Call us! You'll be pleased with the savings and all the built-in advantages you get with Q-F.

Only need a few parts, or help with a complete system? Q-F delivers in 4-to-5 days.

For a complete brochure or Quick-Fit video, call Quick-Fit today: 1-800-532-0830. We want to show you why Q-F is quickly becoming America's premier duct system.

QUICK-FIT™

REES

REES-MEMPHIS, INC.
2426 Channel Avenue P.O. Box 13225
Memphis, Tennessee 38113-0225
Tel: 901-774-8830 Fax: 901-774-5000

U.S. Patent No. 4,924,913

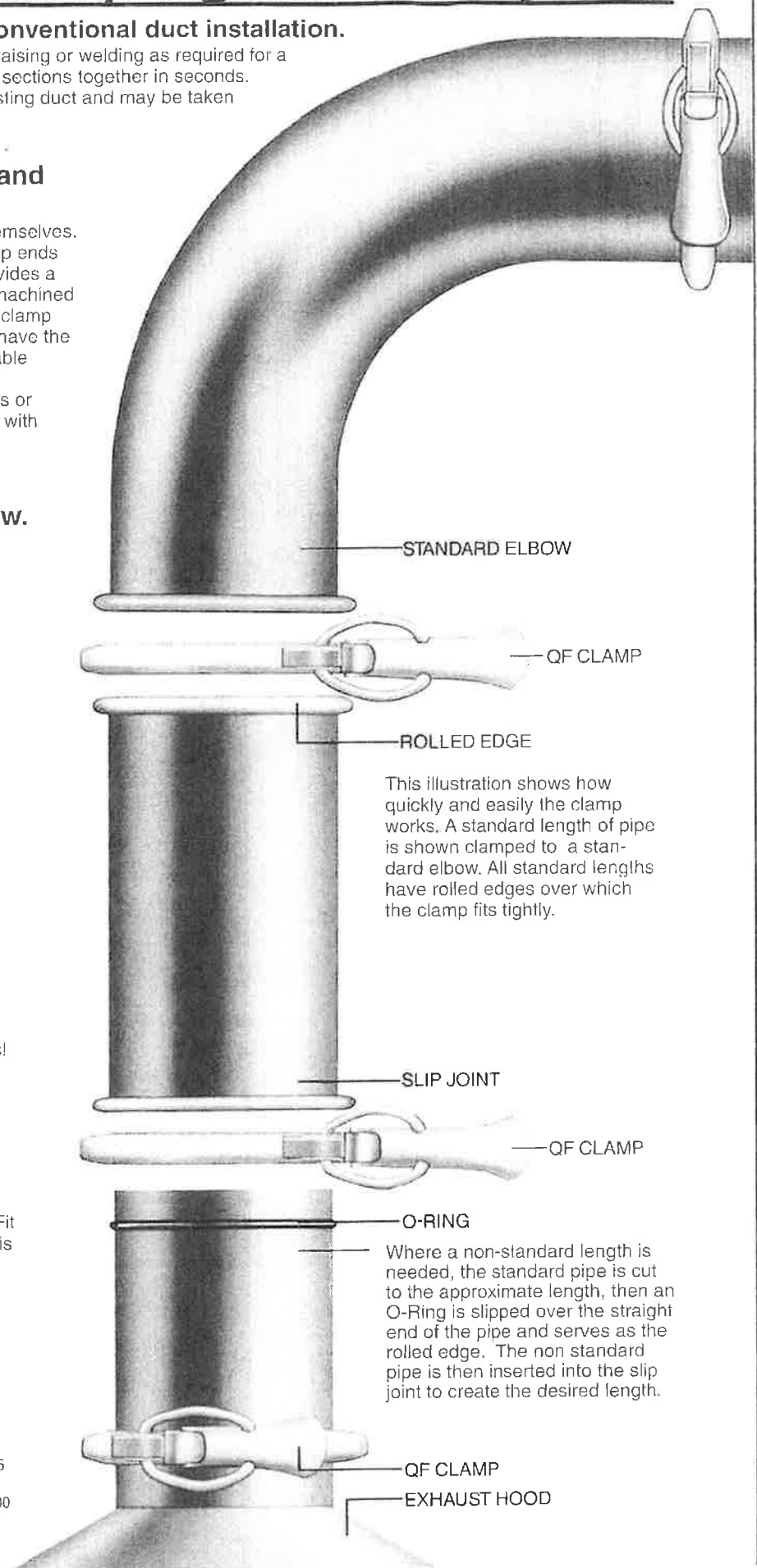

NOTE: BLAST GATE AND FLEX @ EACH DROP

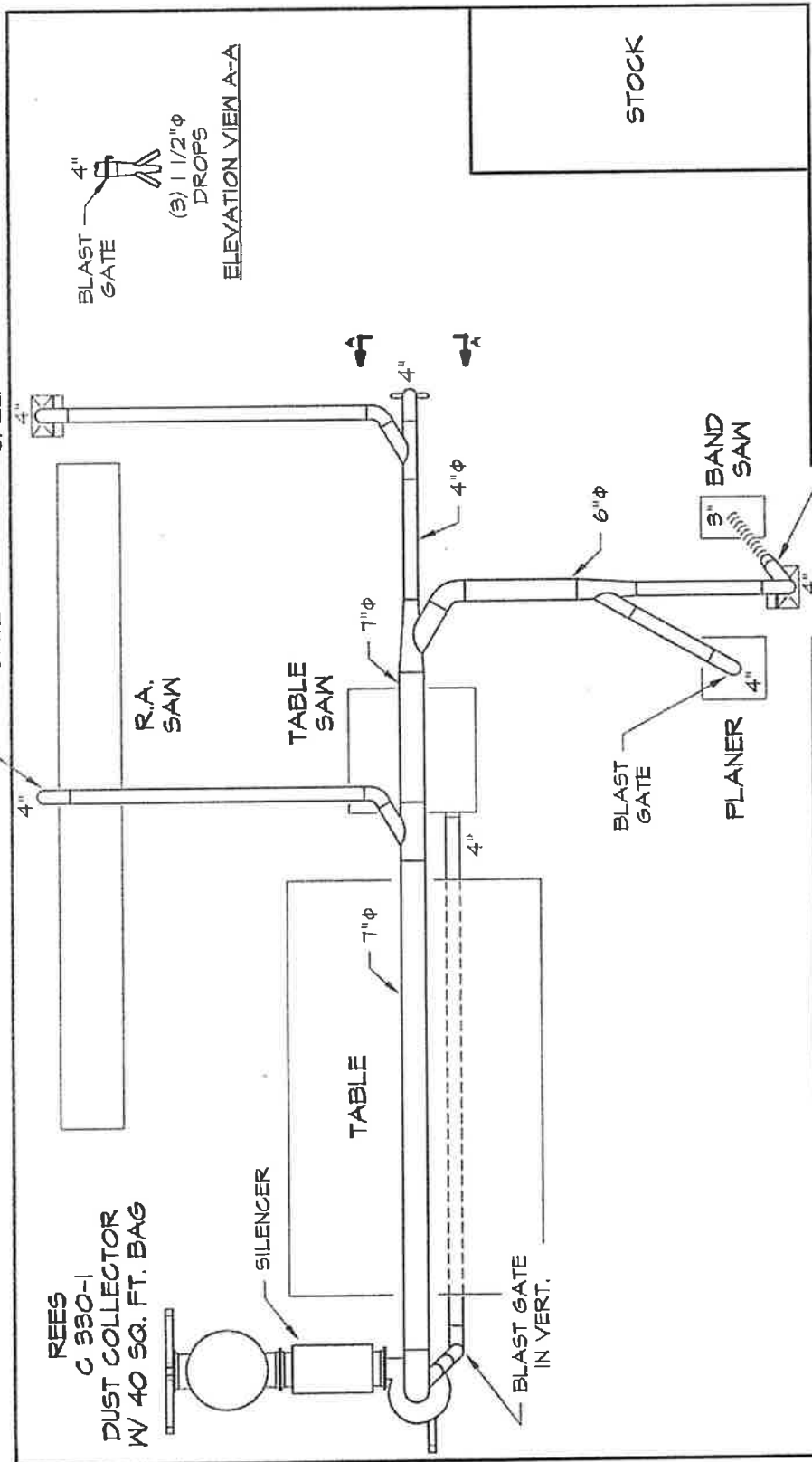

REES
C 330-1
DUST COLLECTOR
W/ 40 SQ. FT. BAG

SILENCER

TABLE

R.A. SAW

TABLE SAW

BLAST GATE

PLANER

BAND SAW

FLOOR SWEEP

3" x 4" TAPER
W/ BLAST GATE
ON 4" TEE

STOCK

BLAST GATE

(3) 1 1/2" φ
DROPS

ELEVATION VIEW A-A

FLOOR SWEEP

NEW HOOD
W/ BLAST
GATE

REES-MEMPHIS, INC.
MEMPHIS, TENNESSEE
USA

MURFREESBORO CITY SCHOOLS

Murfreesboro, TN

DUST COLLECTION SYSTEM

DR BY: J. P. Anderson DWG. NO: P-00053A DATE: 6/1/00 SCALE: 1/4" = 1'

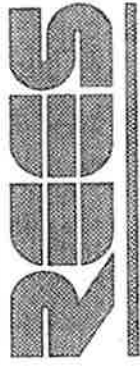



REES-MEMPHIS, INC.
 2426 Channel Avenue P.O. Box 13225
 Memphis, Tennessee 38113-0225
 Tel 901-774-8830 Fax 901-774-5000

PROPOSAL

*615-898-7126
shop office*

*7-14-00
left message
10-31-00
no response to
messages left
filed*

Murfreesboro City Schools
 2552 South Church Street
 Murfreesboro, TN 37130

Number: 2432
 Page: 1
 Date: 06/08/00

Attention: Mr. Larry Willeford

Rees-Memphis, Inc. proposes a dust collection system for your Wood Shop as shown on REES Drawing P-00053A and as described herein.

One (1) REES Model C 330-1 Dust Collector complete with fan, leg assembly, and 1 tube collector. Fan uses a 3-horsepower, 3600 RPM, TEFC motor mounted directly to a cast aluminum housing and wheel, and has a 7-inch diameter inlet collar. Each tube collector includes a filter bag with 40 square feet of cloth, support rods, band clamps, and filter sleeve for connection to a customer supplied 55 gallon drum. (8.2 cubic feet storage capacity per drum). Unit is also supplied with a silencer. Refer to REES Model C Dust Collector Bulletin for complete specifications and performance.

TOTAL PRICE, f.o.b., Memphis, TN\$1,900.00

OPTIONAL FEATURES FOR ABOVE COLLECTOR:

One (1) 55 sq. ft. filter bags in place of standard 40 sq. ft. bags \$45.00
 One (1) 460-volt push-button manual starter(s) \$90.00
 One (1) Plastic storage bags (50 per box)..... \$90.00
 One (1) Lot of "Quick-Fit" pipe and fittings per Drawing P-00053A..... \$2,745.00

ES MASTER
ENERGY EFFICIENT A-C MOTOR

FRAME SIZE	TYPE	P
DESIGN	°CSF	15
AMB	INSUL CLASS	
DUTY	CODE	
ENCL		

PHASE	3
VOLTS	230/460
AMPS	7.8/3.9
HP	3
INSUL CLASS	308C02XPP30A
ENCL	258C02XPP30A

NEMA NOM EFFICIENCY	89.0
GUARANTEED EFFICIENCY	0.5

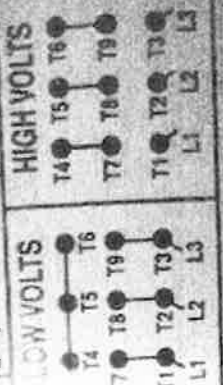

MOTOR WEIGHT

LBS.

3 PHASE 200V 3 HP 3 AMPS, 1.0 S.F.
RELIANCE ELECTRIC INDUSTRIAL CO.
GREENVILLE, SC 29615

MADE IN TAIWAN

613-8-7A

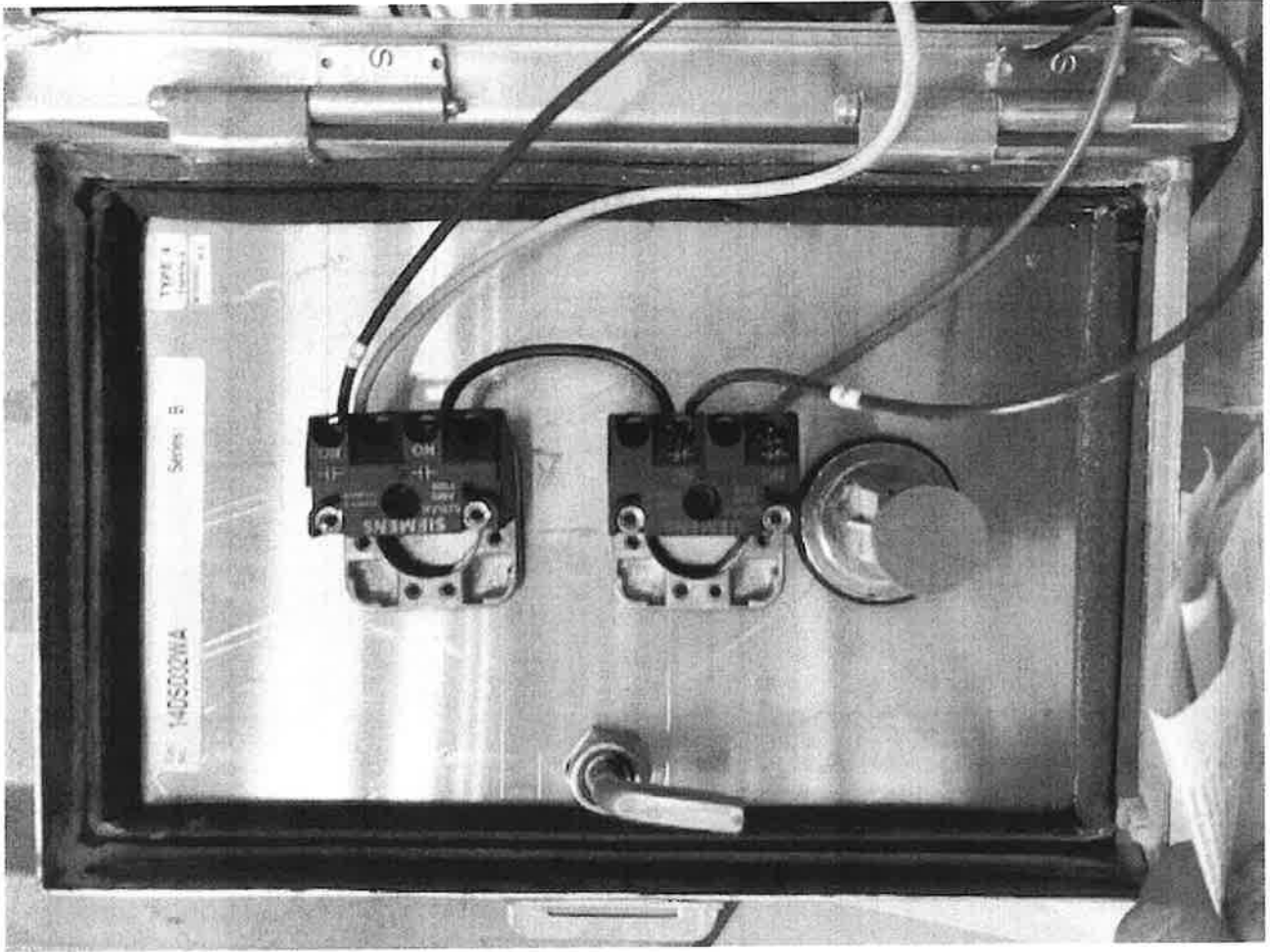

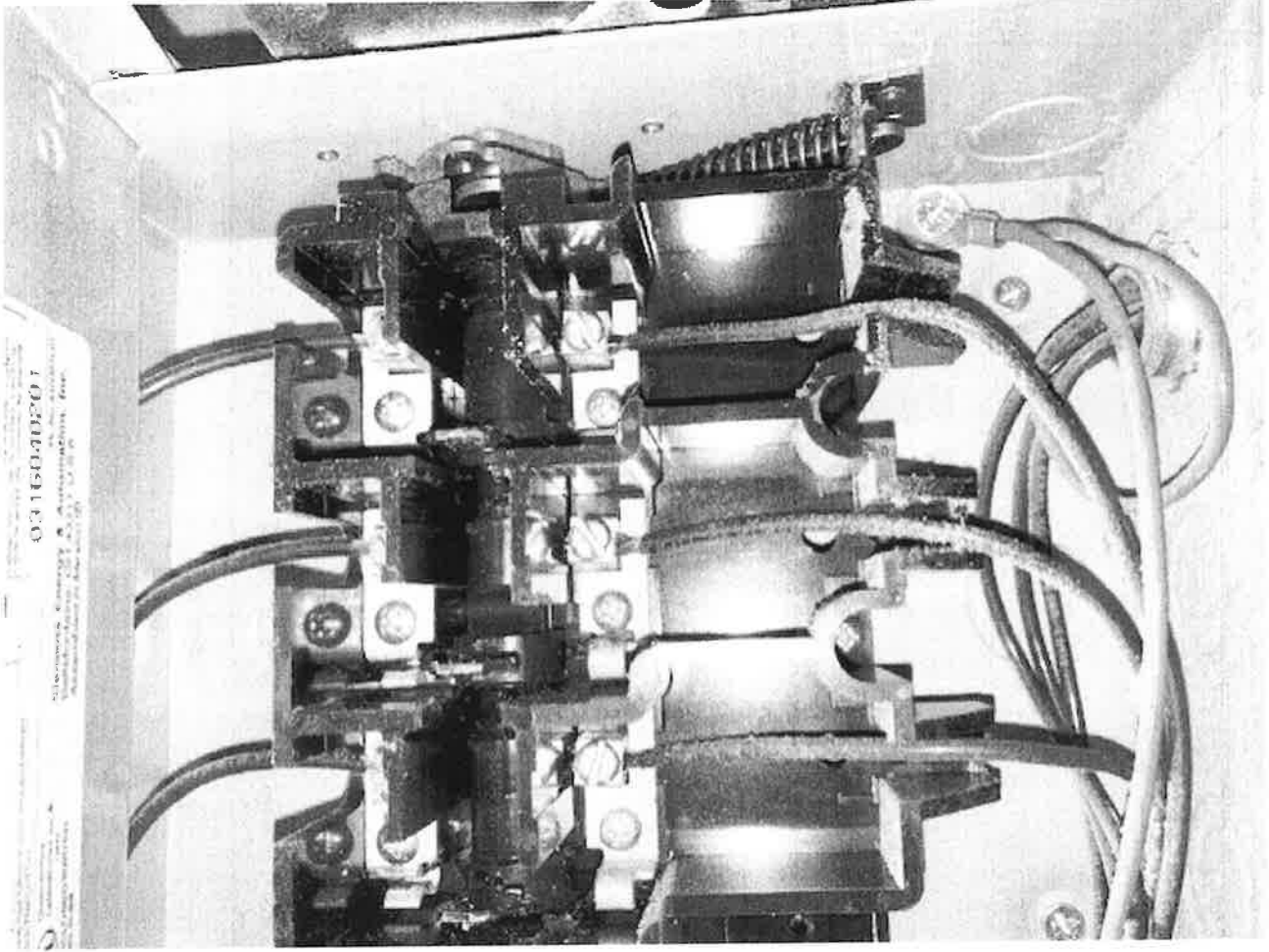

0315040201
Electronics, Controls & Automation Division, Power
Administration Center, Room 3000, 1000

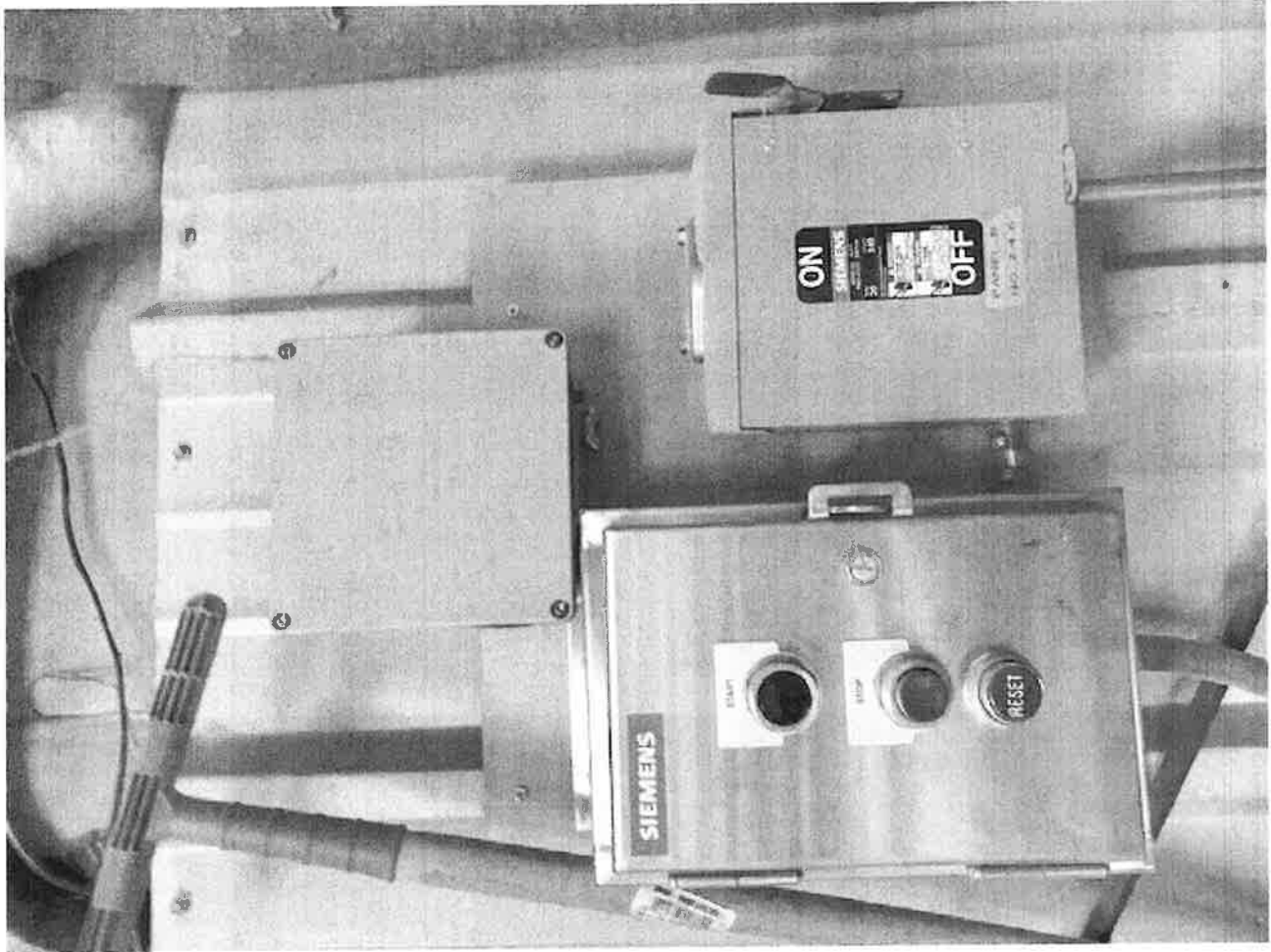

SURPLUS PROPERTY DISPOSAL FORM (SPDF)

Based on Tenn. Code Ann. § 49-6-2007(d)

- (1) Surplus property in local school systems which has no value or has a value less than five hundred dollars (\$500), may be disposed of without the necessity of bids as required by this section.
- (2) In order for such disposal without bids, the principal of the school with the surplus personal property, the superintendent of the local school system, and the chairman of the local board of education, all must agree in written form that the property is of no value or is of a value less than five hundred dollars (\$500).

COMPLETE ALL INFORMATION. A PHOTOGRAPH OF THE ITEMS LISTED BELOW MUST BE ATTACHED. SUBMIT SIGNED ORIGINALS WITH PHOTO TO INVENTORY CONTROL. YOUR SCHOOL OR FACILITY WILL BE CONTACTED CONCERNING DISPOSAL METHOD.

Flex Space - C Pod
Multipurpose/Work Room

EQUIPMENT	TAG #	MFG. BY	MODEL #	SERIAL #	VALUE
Round table	N/A	UNKNOWN	N/A	N/A	10
Upholstered chairs - Broken x4		"		"	0
rectangular table	N/A	"		"	20
green chairs x5	"			"	10
Rocking chair	"			"	20
metal chairs x 4	"			"	15
Angled table	"			"	10
Broken red chairs x5	"			"	0
Large corkboard	"			"	10
Whiteboard easel	"			"	5
Rectangular table	"			"	10

In accordance with Tenn. Code Ann. § 49-6-2007(d)(1) and (d)(2), we the undersigned, authorize disposal of the items listed above.

Principal *William Ballard* School Discovery Date 5/9/25

Supervisor _____ Date _____
 Assistant Superintendent of School Operations or Director of Technology *D. Becht* Date 5/14/25

Director of Schools *Boyd Duke III* Date 5/19/25

Board Chairman _____ Date _____

For inventory control use: copy to central office receiving ___/___/___; copy to principal or supervisor ___/___/___; copy to inventory control ___/___/___; copy to vendor ___/___/___

Notes on Disposal Method:

Signature: _____ Date: _____

Dena Thomas

From: Caitlin Bullard <caitlinelizabethbullard@gmail.com>
Sent: Monday, May 12, 2025 9:18 AM
To: Dena Thomas
Subject: DS Surplus
Attachments: DS Surplus 5-12-25 0662_001.pdf

WARNING: This email originated outside of Murfreesboro City Schools. DO NOT CLICK links or attachments unless you recognize the sender and verify the content is safe.

Good morning,

Please find a surplus form and corresponding photos attached.

Thanks,

Dr. Caitlin Bullard
Principal
Discovery School
@DSExplorers

Mission: To creatively challenge students to explore, discover, and develop their personal and academic potential.











SURPLUS PROPERTY DISPOSAL FORM (SPDF)

Based on Tenn. Code Ann. § 49-6-2007(d)

- (1) Surplus property in local school systems which has no value or has a value less than five hundred dollars (\$500), may be disposed of without the necessity of bids as required by this section.
- (2) In order for such disposal without bids, the principal of the school with the surplus personal property, the superintendent of the local school system, and the chairman of the local board of education, all must agree in written form that the property is of no value or is of a value less than five hundred dollars (\$500).

COMPLETE ALL INFORMATION. A PHOTOGRAPH OF THE ITEMS LISTED BELOW MUST BE ATTACHED. SUBMIT SIGNED ORIGINALS WITH PHOTO TO INVENTORY CONTROL. YOUR SCHOOL OR FACILITY WILL BE CONTACTED CONCERNING DISPOSAL METHOD.

EQUIPMENT	TAG #	MFG. BY	MODEL #	SERIAL #	VALUE
Old Computer - Library @ NF	959015		Will not update		20 <20
Old clear touch panels @ NF	5858 + 5859				<20
Old Computer - will not update	5253				<20

In accordance with Tenn. Code Ann. § 49-6-2007(d)(1) and (d)(2), we the undersigned, authorize disposal of the items listed above.

Hunter Brown - Tech School NF Date 4/30/25
Principal

Dena Thomas PA Date 4/30/25
Supervisor

April Bawson Date 5/8/25
Assistant Superintendent of School Operations or Director of Technology

Bobby W Duke III Date 5/8/25
Director of Schools

Board Chairman Date _____

For inventory control use: copy to central office receiving ___/___/___; copy to principal or supervisor ___/___/___; copy to inventory control ___/___/___; copy to vendor ___/___/___

Notes on Disposal Method:

Signature: _____ Date: _____



NF old library
computer



NF Promethea



NORTHFIELD DISPOSAL
APRIL 23/2025

Number	Location	Cleartouch Model Number	Asset Tag	Serial Number	Onboard/Computer Model Number	Asset Tag	Serial Number	Computer	Asset Tag	Serial Number
1	A4	6075U	5858	4018080100084	Dell Optiplex 3040	5259	HHR0SD2	Dell Optiplex 9020	959015	28SX0Z1
2	A5	5070H+	NA	L70AAVY169A-240160601566XA0102	Dell Optiplex 3050	NA	FZ69BQ2			
3	D6	6070U	NA	40170728000622	Dell Optiplex 3050	NA	DT3NCS2			
4	D9	6065U	NA	40180830000192	Dell Optiplex 3050	NA	D8QBIL2			
5	F5	6075U	5859	40180601000230	Dell Optiplex 3050	NA	FZ5DBQ2			
6	E3	6065U	NA	40180903000298	Dell Optiplex 3050	NA	DT3LCS2			
7	E5	6065U	NA	40180830000057	Dell Optiplex 3060	NA	82WZDT2			

SURPLUS PROPERTY DISPOSAL FORM (SPDF)

Based on Tenn. Code Ann. § 49-6-2007(d)

- (1) Surplus property in local school systems which has no value or has a value less than five hundred dollars (\$500), may be disposed of without the necessity of bids as required by this section.
- (2) In order for such disposal without bids, the principal of the school with the surplus personal property, the superintendent of the local school system, and the chairman of the local board of education, all must agree in written form that the property is of no value or is of a value less than five hundred dollars (\$500).

COMPLETE ALL INFORMATION. A PHOTOGRAPH OF THE ITEMS LISTED BELOW MUST BE ATTACHED. SUBMIT SIGNED ORIGINALS WITH PHOTO TO INVENTORY CONTROL. YOUR SCHOOL OR FACILITY WILL BE CONTACTED CONCERNING DISPOSAL METHOD.

EQUIPMENT	TAG #	MFG. BY	MODEL #	SERIAL #	VALUE
See Attached					

In accordance with Tenn. Code Ann. § 49-6-2007(d)(1) and (d)(2), we the undersigned, authorize disposal of the items listed above.

Andrea G School Scalco Date 5/20/25
Principal

Supervisor Date _____
Bob Zawon Date 5/21/2025
Assistant Superintendent of School Operations or Director of Technology

Bobby W Duke III Date 5/21/2025
Director of Schools

Board Chairman Date _____

For inventory control use: copy to central office receiving ___/___/___; copy to principal or supervisor ___/___/___; copy to inventory control ___/___/___; copy to vendor ___/___/___

Notes on Disposal Method:

Signature: _____ Date: _____

<u>Equipment</u>	<u>Tag#</u>	<u>MFG By</u>	<u>Model #</u>	<u>Serial #</u>	<u>Value</u>
Apple TV	N/A	Apple	A1469	DY3K8UMRFF54	\$0
Apple TV	90	Apple	A1469	COHKHS0KFF54	\$0
Apple TV	N/A	Apple	A1469	F6MLL3HVFF54	\$0
Apple TV	87	Apple	A1469	C1MKK91SFF54	\$0
					\$0
					\$0

Apple TV operating system won't update/over 10 years old

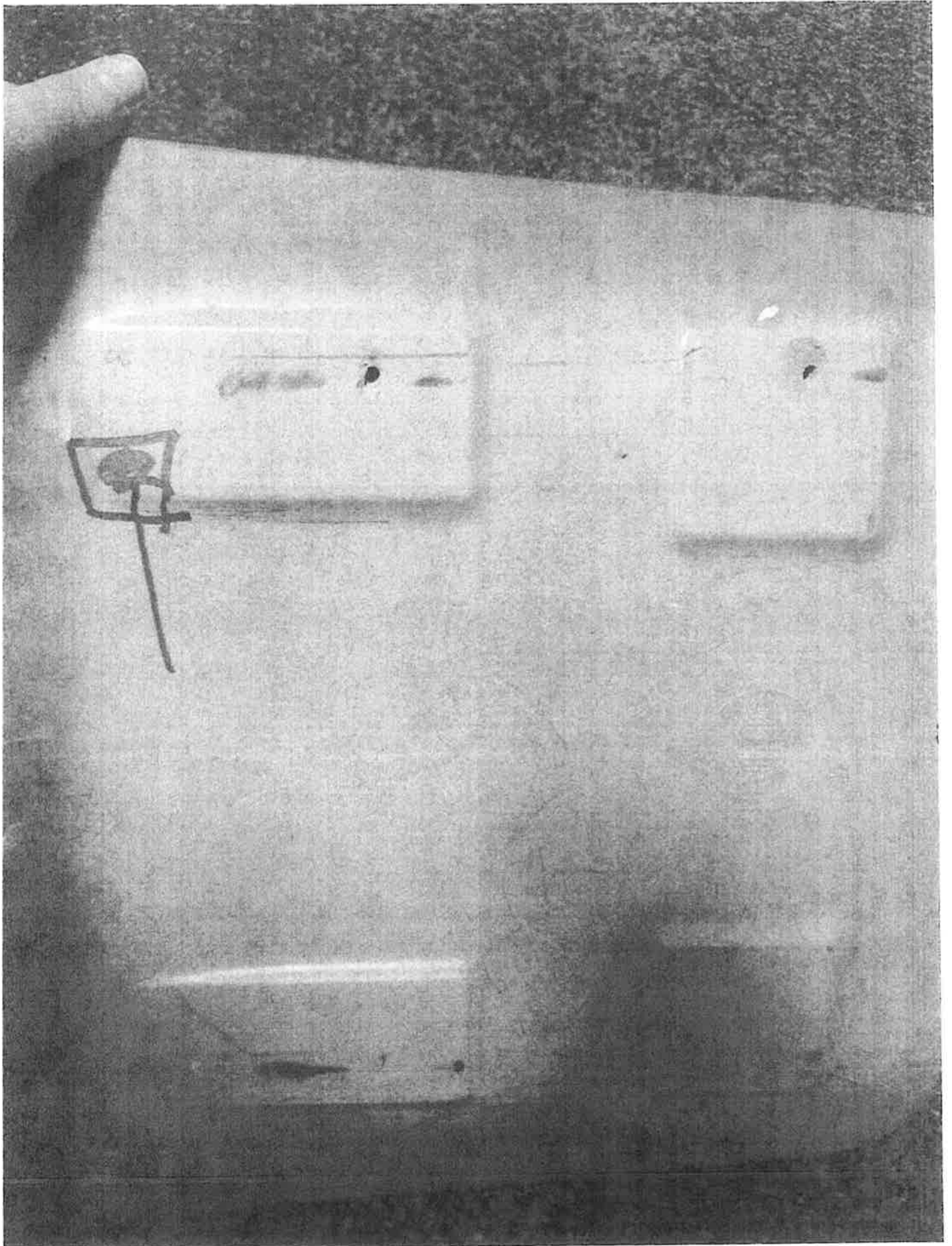

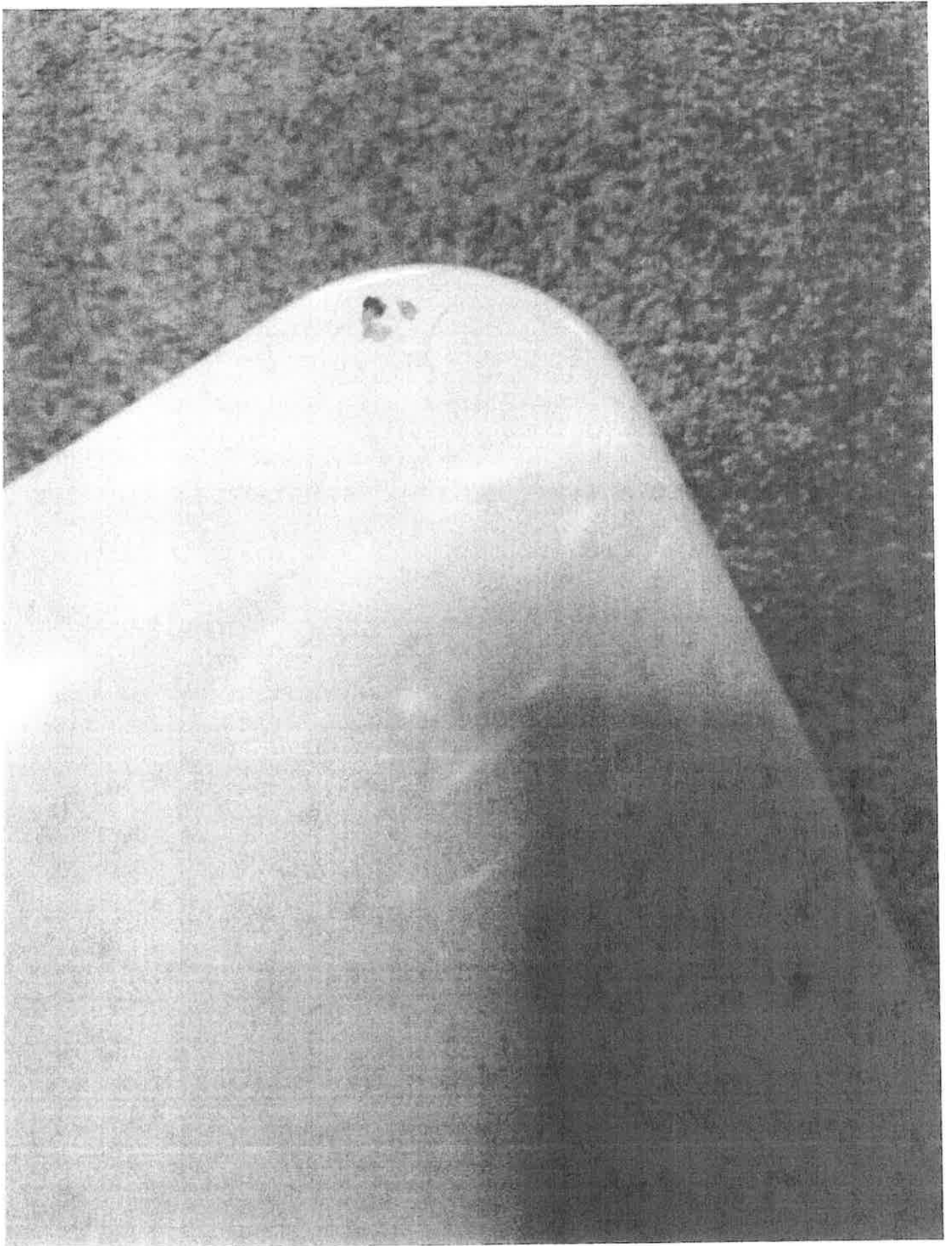

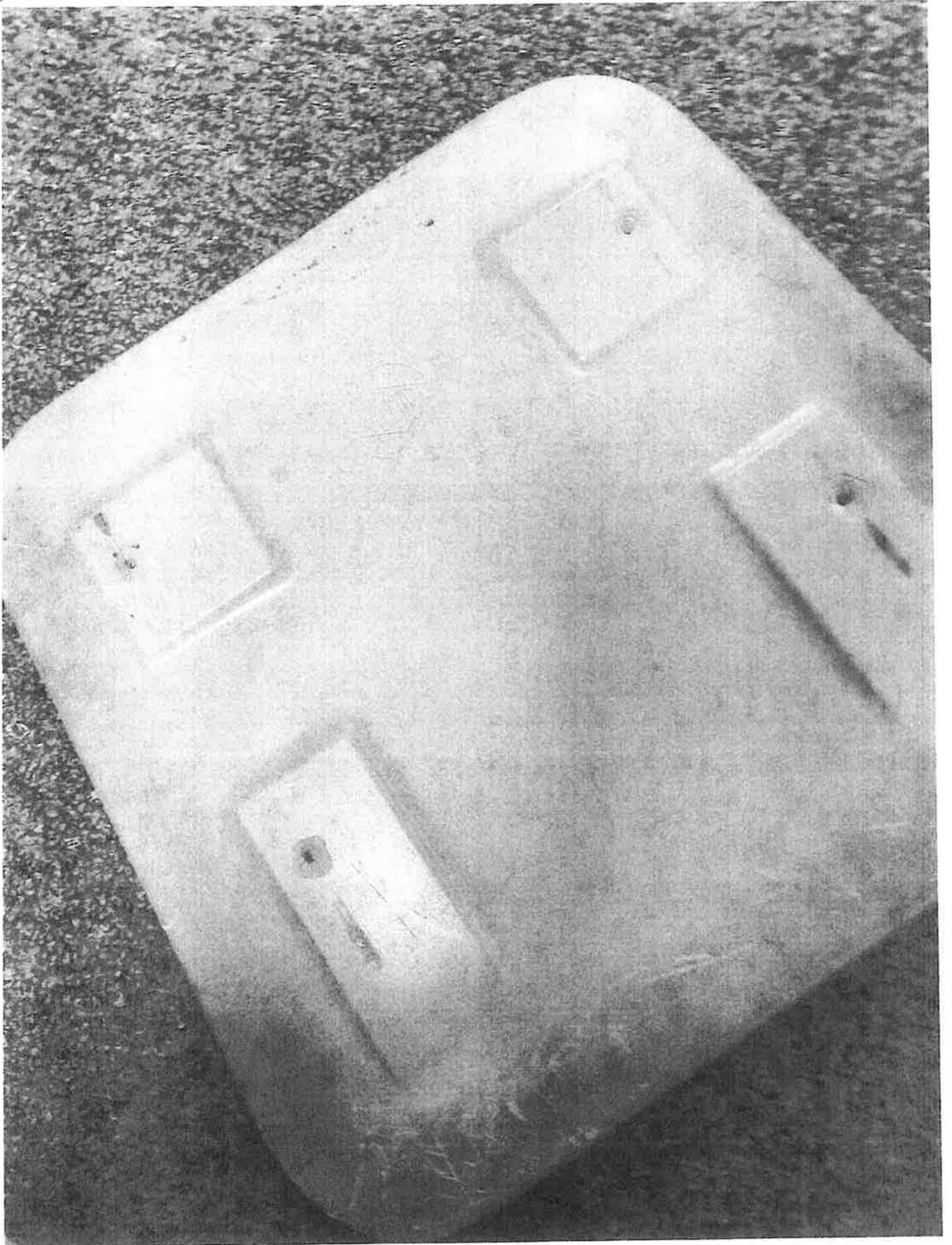

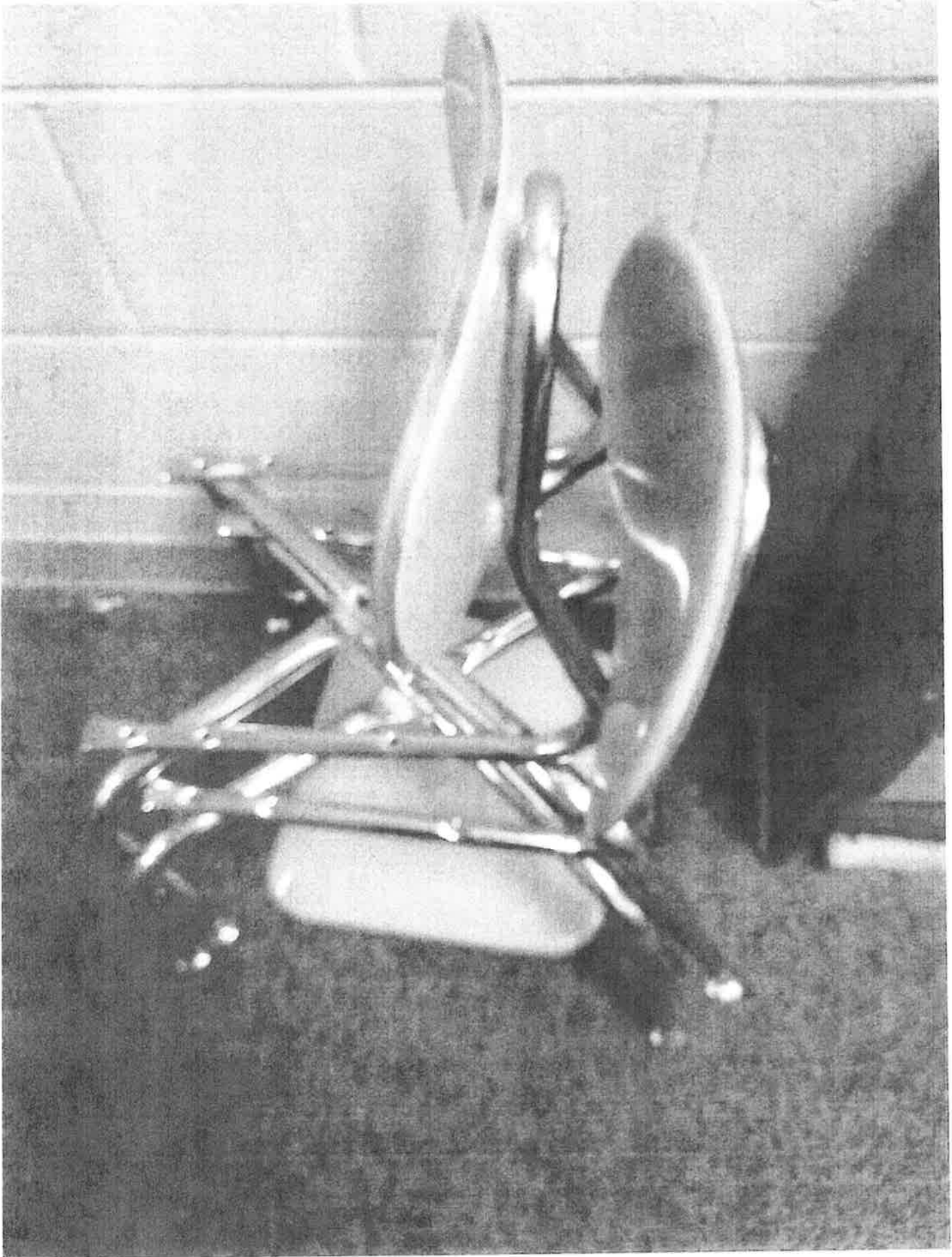

SURPLUS PROPERTY DISPOSAL FORM (SPDF)

Based on Tenn. Code Ann. § 49-6-2007(d)

- (1) Surplus property in local school systems which has no value or has a value less than five hundred dollars (\$500), may be disposed of without the necessity of bids as required by this section.
- (2) In order for such disposal without bids, the principal of the school with the surplus personal property, the superintendent of the local school system, and the chairman of the local board of education, all must agree in written form that the property is of no value or is of a value less than five hundred dollars (\$500).

COMPLETE ALL INFORMATION. A PHOTOGRAPH OF THE ITEMS LISTED BELOW MUST BE ATTACHED. SUBMIT SIGNED ORIGINALS WITH PHOTO TO INVENTORY CONTROL. YOUR SCHOOL OR FACILITY WILL BE CONTACTED CONCERNING DISPOSAL METHOD.

EQUIPMENT	TAG #	MFG. BY	MODEL #	SERIAL #	VALUE
Keyboard		Debut Music		250310	all were given to J MVE from Cason Lane in July, 2022. They are old but downok
Keyboard		Debut Music		260366	
Keyboard		Debut Music		230310	
Keyboard		Debut Music		260367	
Keyboard		Debut Music		260376	
Keyboard		Debut Music		220316	
Keyboard		Debut Music		250398	
Keyboard		Debut Music		250313	
Keyboard		Yamaha	PSR 340	9146374	
Keyboard		Yamaha	PSR 340	9047141	
Keyboard		Yamaha	PSR 340	9057842	
Keyboard		Yamaha	PSR 340	9047426	
Keyboard		Yamaha	PSR 350	13180	
Keyboard		Yamaha	PSR 550	11566	
Keyboard		Yamaha	PSR 550	109019	

In accordance with Tenn. Code Ann. § 49-6-2007(d)(1) and (d)(2), we the undersigned, authorize disposal of the items listed above.

Principal: [Signature] School Mitchell-Neilson Elem Date 5/21/2025

Supervisor: [Signature] Date 5/21/25

Director of Schools: [Signature] Date 5/21/25

Board Chairman: _____ Date _____

For inventory control use: copy to central office receiving ___/___/___; copy to principal or supervisor ___/___/___; copy to inventory control ___/___/___; copy to vendor ___/___/___

Notes on Disposal Method:

Signature: _____ Date: _____

All are in Music Room at Elementary - Room # D-117
 There are 2 boxes to go with keyboards that include power cords & stands.

Dena Thomas

From: Sherry Givens
Sent: Wednesday, May 21, 2025 9:39 AM
To: Dena Thomas
Cc: Jessica Scruggs
Subject: MNE-MUSIC Keyboards Disposal 5-21-25
Attachments: DISPOSAL OF SURPLUS-MNE MUSIC 5-21-25.pdf

Dena,

Attached please find the disposal of asset form for the keyboards at MNElem/Music Room, D 117, to get moved to storage at Hobgood.

Photos to come---

These were all given to MN from CLA in 2022, so they are old and have been replaced by newer ones given to us by Scales.

PHotos to come

Sherry Givens, Bookkeeper
Mitchell-Neilson Schools
(615) 890-7841
sherry.givens@cityschools.net

Dena Thomas

From: Sherry Givens
Sent: Wednesday, May 21, 2025 9:39 AM
To: Dena Thomas
Cc: Jessica Scruggs
Subject: Fw: Music keyboards

PHoto of keyboards in closet

Sherry Givens, Bookkeeper

Mitchell-Neilson Schools
Elementary Campus
711 W. Clark Blvd.
Murfreesboro, TN 37129
(615) 890-7841, Ext. 10709
sherry.givens@cityschools.net



From: Sherry Givens <sherry.givens@icloud.com>
Sent: Wednesday, May 21, 2025 9:27 AM
To: Sherry Givens <Sherry.Givens@cityschools.net>
Subject: Music keyboards

WARNING: This email originated outside of Murfreesboro City Schools. DO NOT CLICK links or attachments unless you recognize the sender and verify the content is safe.



Sent from my iPhone

Dena Thomas

From: Sherry Givens
Sent: Wednesday, May 21, 2025 9:39 AM
To: Dena Thomas
Cc: Jessica Scruggs
Subject: Fw: Music keyboard misc

PHotos of boxes of power cords for keyboards

Sherry Givens, Bookkeeper

Mitchell-Neilson Schools
Elementary Campus
711 W. Clark Blvd.
Murfreesboro, TN 37129
(615) 890-7841, Ext. 10709
sherry.givens@cityschools.net



From: Sherry Givens <sherry.givens@icloud.com>
Sent: Wednesday, May 21, 2025 9:27 AM
To: Sherry Givens <Sherry.Givens@cityschools.net>
Subject: Music keyboard misc

WARNING: This email originated outside of Murfreesboro City Schools. DO NOT CLICK links or attachments unless you recognize the sender and verify the content is safe.

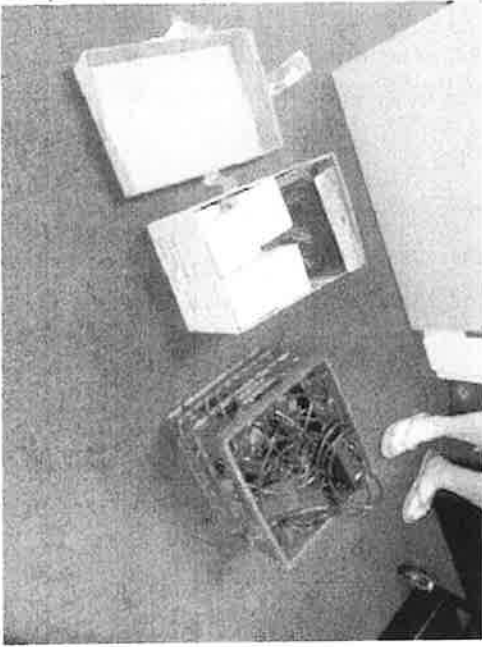

Sent from my iPhone

Agenda Item Title: Board Policy 6.401, Student Health Services, on first reading

Board Meeting Date: May 27, 2025

Department: Legal

Presented by: Lauren Bush

Board Agenda Category:

- Consent Agenda
- Action Item
- Reports and Information

Requires City Council Approval: Yes No

Summary

For the Board’s consideration, Policy 6.401 is a new policy adoption regarding Student Health Services, designed to align with the *Guidelines for Health Care in a School Setting* jointly issued by the Tennessee Departments of Education and Health, as well as Public Chapter 0165 that requires at least one full-time employee, who is not a school nurse be trained annually in seizure safety and first aid.

Staff Recommendation

Approve Board Policy 6.401, Student Health Services, on first reading.

Fiscal Impact

No fiscal impact

Connection to MCS’s Five-Year Strategic Plan

- Known:** Every student will be *known* through whole-child programs and support.
- Safe:** Every student will be *safe* through equitable access to buildings, facilities, and infrastructure that meets their needs.
- Challenged:** Every student will be *challenged* by learning from highly effective educators and employees.
- Empowered:** Every student will be *empowered* through academic success

Murfreesboro City School Board

Monitoring: Review: Annually, in April	Descriptor Term: <h2 style="text-align: center;">Student Health Services</h2>	Descriptor Code: <h3 style="text-align: center;">6.401</h3>	Issued Date: Click here to enter a date.
		Rescinds:	Issued:

1 The district shall employ licensed healthcare professionals to oversee student health services. Each
 2 school nurse employed by the district shall maintain current certification through a certifying
 3 cardiopulmonary resuscitation course to practice in a public school setting.¹

4 Each school shall have a School Health Office designed and equipped to ensure proficient assessment,
 5 delivery, and evaluation of student health needs. Health offices should provide for privacy and safety
 6 and include necessary equipment and supplies. The school health services program shall include, at a
 7 minimum:¹

- 8 1. Physical Examinations: Requirement for a physical examination for every child entering school
 9 for the first time and for students participating in interscholastic athletics, performed by a licensed
 10 healthcare provider.
- 11 2. Immunization Verification: Procedures to verify proof of immunization for all students, except
 12 those exempted by law.
- 13 3. Communicable Disease Policy: Policies for excluding students with communicable diseases and
 14 readmitting them post-recovery, in line with the Department of Health’s regulations.
- 15 4. Medication Administration: Protocols for the administration of medications, including emergency
 16 medications, by licensed personnel or trained volunteers, as permitted by law.
- 17 5. Health Screenings: Regular vision, hearing, scoliosis, and other health screenings as
 18 recommended by the Tennessee Department of Education.
- 19 6. Emergency Care: Provision of first aid and emergency care procedures, including the development
 20 of Emergency Care Plans (ECPs) for students with specific health needs.
- 21 7. Individual Health Plans (IHPs): Development and annual review of IHPs for students with chronic
 22 health conditions, outlining necessary accommodations and emergency procedures.

23 At least one full-time employee, who is not a school nurse, must be trained annually in seizure safety
 24 and first aid. The Director of Schools shall develop administrative procedures for the delegation of
 25 specific health tasks to trained, unlicensed personnel, with training from licensed professionals.

Legal Reference:

1. *Guidelines for use of Health Care Professionals and Health Care Procedures in a School Setting*

Cross References:

*(Tennessee Department of Education and Tennessee
Department of Health 2019)*

2. Public Acts of 2025, Chapter No. 0165

Communicable Diseases 6.403

Medicines 6.405

Agenda Item Title: Summer Learning Grants Budget Amendment for 2024-2025 School year

Board Meeting Date: May 27, 2025

Department: Finance

Presented by: Trey Duke, Director

Board Agenda Category:

Consent Agenda

Action Item

Reports and Information

Requires City Council Approval: Yes No

Summary

This amendment transfers \$97,207 of previously approved revenue and expenditures for Summer Learning. \$72,207 in revenue will be transferred from the Summer Learning Transportation Grant to Summer Learning programming grant to address a clerical error. \$25,000 of expenditures for Summer Learning will be moved from Other Supplies and Materials to provide janitorial services during summer school.

Staff Recommendation

To approve the FY25 budget amendment to recognize the transfer of revenue and expenditures for Summer Learning.

Fiscal Impact

\$97,207 of transfers for summer learning with no impact on fund balance.

Connection to MCS's Five-Year Strategic Plan

- Known:** Every student will be *known* through whole-child programs and support.
- Safe:** Every student will be *safe* through equitable access to buildings, facilities, and infrastructure that meets their needs.
- Challenged:** Every student will be *challenged* by learning from highly effective educators and employees.
- Empowered:** Every student will be *empowered* through academic success.

Murfreesboro

City Schools

INTER-FUND BUDGET TRANSFER/AMENDMENT REQUEST

Budget Fiscal Year FY2025 General Purpose School Fund 141

Account	Description	Increase	Decrease
141 R 46590	Other State Grants	72,207	
141 R 47590	Other Federal Through State	-	72,207
141 E 72610 328	Janitorial Services	25,000	
141 E 71100 499	Other Supplies & Materials	-	25,000
Total		\$ 97,207	\$ 97,207

Explanation: To transfer \$72,207 from Other Federal to Other State Grants to correct the FY25 Summer Learning
Camp previously approved. Also, transferring \$25,000 from Other Supplies & Materials to Janitorial
Services for Summer School cleaning.

Dan Kemp
 Reviewed by Finance Director/Finance Manager

5/21/25
 Date

Approved	<input checked="" type="checkbox"/>	<u><i>Bobby W Duke III</i></u> Director of Schools	<u>5/21/25</u> Date
Declined	<input type="checkbox"/>		

Agenda Item Title: 21st Century Learning Grant Budget Amendment

Board Meeting Date: May 27, 2025

Department: Finance

Presented by: Trey Duke, Director

Board Agenda Category:

- Consent Agenda
- Action Item
- Reports and Information

Requires City Council Approval: Yes No

Summary

MCS was awarded a \$17,750 supplement within the 21st Century Learning grant budget to be used for Science/STEAM enrichments. Funds from this grant will be used to implement and sustain Kid Spark Education, a comprehensive, hands-on STEM program designed to support student learning and engagement. The program provides age-appropriate, structured curriculum modules that build progressively in complexity, ensuring students develop critical 21st-century skills in engineering, robotics, coding, and problem-solving.

Grant funds will be allocated toward the purchase of Kid Spark mobile STEM labs, educator training, and supplemental materials. These mobile labs come fully equipped with reusable components and lesson plans, allowing our staff to seamlessly integrate STEM into afterschool environments.

Staff Recommendation

To approve the FY25 budget amendment to recognize the new revenue and corresponding expenditures for the 21st CCLC grant in the Federal Projects fund.

Fiscal Impact

\$17,750 of new revenue with corresponding expenditures. There will be no impact on fund balance.

Connection to MCS's Five-Year Strategic Plan

- Known:** Every student will be *known* through whole-child programs and support.
- Safe:** Every student will be *safe* through equitable access to buildings, facilities, and infrastructure that meets their needs.
- Challenged:** Every student will be *challenged* by learning from highly effective educators and employees.
- Empowered:** Every student will be *empowered* through academic success.

Murfreesboro City Schools Budget Amendment

Federal Projects Fund 142
Fiscal Year 2024-25

Account Number	Account Description	BUDGET AS PASSED OR PREV AMENDED	AMENDED BUDGET	AMENDMENT INCREASE (DECREASE)
<u>Revenues</u>				
142 R 47150	21st CCLC Grant	\$ 571,157	\$ 588,907	\$ 17,750
Total Increase in Revenues		\$ 571,157	\$ 588,907	\$ 17,750
<u>Expenditures</u>				
142 E 73300 429	Other Supplies & Materials	\$ 5,520	\$ 22,770	\$ 17,250
142 E 73300 524	In-Service/Staff Development	1,292	1,792	500
Total Increase in Expenditures		\$ 6,812	\$ 24,562	\$ 17,750

CHANGE IN FUND BALANCE (CASH) -

New revenue of \$17,750 from the Kid Spark Education Program to offer a dynamic and inclusive approach to STEM learning. The corresponding expenditures will be for Supplies, Materials, and Staff Development. This will not affect fund balance.

D. J. [Signature] 5/21/25
Reviewed by Finance Director/Finance Manager Date

Approved	<input checked="" type="checkbox"/>	<u><i>Bobby W. Dull III</i></u>	<u>5/21/25</u>
		Director of Schools	Date
Declined	<input type="checkbox"/>		

Agenda Item Title: School Nutrition Budget Amendment FY25

Board Meeting Date: May 27, 2025

Department: Finance

Presented by: Trey Duke, Director

Board Agenda Category:

Consent Agenda

Action Item

Reports and Information

Requires City Council Approval: Yes No

Summary

This amendment transfers \$1,200 of previously approved expenditures for the nutrition department. This transfer will move \$1,200 of savings from food supplies to the other charges budget line. This will be used to cover State of TN permits for the district's kitchens for 2025-2026.

Staff Recommendation

To approve the FY25 budget amendment to recognize the transfer of expenditures for the nutrition department.

Fiscal Impact

Transfer of \$1,200 with no impact on fund balance.

Connection to MCS's Five-Year Strategic Plan

- Known:** Every student will be *known* through whole-child programs and support.
- Safe:** Every student will be *safe* through equitable access to buildings, facilities, and infrastructure that meets their needs.
- Challenged:** Every student will be *challenged* by learning from highly effective educators and employees.
- Empowered:** Every student will be *empowered* through academic success.

Murfreesboro

City Schools

INTER-FUND BUDGET TRANSFER/AMENDMENT REQUEST

Budget Fiscal Year FY2025 Central Cafeteria Fund 143

Account	Description	Increase	Decrease
143 E 73100 599	Other Charges	1,200	-
143 E 73100 422	Food Supplies	-	1,200
Total		\$ 1,200	\$ 1,200

Explanation: To transfer \$1,200 in previously budgeted expenditures out of Food Supplies to Other Charges. This will be used for State permits for the district's kitchens. This will not affect fund balance.

D. J. [Signature]

5/21/25

Reviewed by Finance Director/Finance Manager

Date

Approved	<input checked="" type="checkbox"/>	<i>Bobby D. [Signature]</i>	<i>5/21/25</i>
Declined	<input type="checkbox"/>	Director of Schools	Date

Agenda Item Title: Recommendation to Murfreesboro City Council Regarding Lease Agreement with Read to Succeed

Board Meeting Date: May 27, 2025

Department: Director of Schools

Presented by: Trey Duke

Board Agenda Category:

- Consent Agenda
- Action Item
- Reports and Information

Requires City Council Approval: Yes No

Summary

Murfreesboro City Schools (MCS) facilitated the acquisition of the property located at 910 Ridgley Road. Although the acquisition was initiated by MCS for school district purposes, the property is held in title by the City of Murfreesboro. MCS initiated a lease agreement with Read to Succeed for office space on the property, acknowledging the contributions by Read to Succeed in the district's own mission. Although MCS initiated this lease, the City of Murfreesboro holds legal title to the property and, therefore, must serve as the lessor in the lease agreement. MCS respectfully requests that the Board provide a formal recommendation to Murfreesboro City Council in support of the proposed lease agreement.

Staff Recommendation

Staff recommends that the Board adopt the attached Board Recommendation in support of the lease agreement between the City and Read to Succeed

Fiscal Impact

Murfreesboro City Schools will receive \$1,600 in rental payments over the course of the lease term. These funds will be deposited into the district's general fund and may be used to support operational or programmatic needs.

Connection to MCS's Five-Year Strategic Plan

- Known:** Every student will be *known* through whole-child programs and support.
- Safe:** Every student will be *safe* through equitable access to buildings, facilities, and infrastructure that meets their needs.
- Challenged:** Every student will be *challenged* by learning from highly effective educators and employees.
- Empowered:** Every student will be *empowered* through academic success

**RECOMMENDATION BY THE
MURFREESBORO CITY SCHOOLS BOARD OF EDUCATION
ENDORING LEASE WITH READ TO SUCCEED**

WHEREAS, Murfreesboro City Schools initiated a lease arrangement for the property located at 910 Ridgely Road, Murfreesboro, TN 37127 in furtherance of its operational goals; and

WHEREAS, the district seeks to enter into a lease arrangement with Read to Succeed, a nonprofit organization committed to promoting literacy, and acknowledges the alignment between the mission of Read to Succeed and the Murfreesboro City Schools strategic plan for student and family engagement in literacy efforts; and

WHEREAS, the City of Murfreesboro holds legal title to the property and, therefore, must serve as the lessor in the proposed lease agreement; and

WHEREAS, the Board wishes to provide a formal recommendation to the Murfreesboro City Council in support of the lease, given the Board's role in initiating the lease and the intended educational benefit to the district and broader community;

NOW, THEREFORE, BE IT RECOMMENDED THAT the Murfreesboro City School Board supports the proposed lease agreement between the City of Murfreesboro and Read to Succeed and recommends its approval by the Murfreesboro City Council.

Approved this 27th day of May, 2025.

CHAIRMAN OF THE BOARD



Butch Campbell

DIRECTOR OF SCHOOLS



Bobby N. Duke, III

Agenda Item Title: Finalsite Agreement for Mass Notification Services

Board Meeting Date: May 27, 2025

Department: Communications

Presented by: Trey Duke

Board Agenda Category:

- Consent Agenda
- Action Item
- Reports and Information

Requires City Council Approval: Yes No

Summary

MCS recommends approval of a contract with Finalsite to provide Mass Notification Services, including voice, text, and email to families and staff. This platform will enhance communication for emergencies, attendance, and general announcements, with seamless integration into existing systems. Finalsite was selected for its functionality, ease of use, and competitive pricing.

Staff Recommendation

Approve Finalsite Agreement for Mass Notification Services

Fiscal Impact

The FinalSite agreement consists of five one-year terms that auto-renew annually, with an initial cost of \$15,000 for year one and \$15,880 per year for years two through five. The total potential cost over five years is \$77,520. The district may terminate the agreement with written notice at least 90 days before the end of any one-year term. Funding is provided through the FY26 General Purpose funds.

Connection to MCS's Five-Year Strategic Plan

- Known:** Every student will be *known* through whole-child programs and support.
- Safe:** Every student will be *safe* through equitable access to buildings, facilities, and infrastructure that meets their needs.
- Challenged:** Every student will be *challenged* by learning from highly effective educators and employees.
- Empowered:** Every student will be *empowered* through academic success

This **Finalsite Order (the 'Order')** is entered into by and between Active Internet Technologies, dba Finalsite ('Finalsite') and Murfreesboro City School District ("Customer") and sets forth the terms of Customer's use of the products and services set forth below ("**Pricing Summary**"). This Order, together with the Master Terms and Conditions for Services (the "**Master Terms**") located at <https://www.finalsite.com/masterterms/useducationagencies> and incorporated herein by this reference, form the entire agreement between the parties in respect of the products and services set forth below. Each of the individuals executing this Order represent and warrant that he or she is authorized to execute this Order on behalf of Customer or Finalsite, as applicable. Unless otherwise specified herein, any capitalized terms used in this Order shall have the meaning defined in the Master Terms.

In consideration of the promises set forth herein, and other good and valuable consideration, the receipt of which are hereby acknowledged, the parties hereby agree as follows:

A. Products and Services Pricing Summary

** Indicates products added*

[X] *Indicates products removed*

CMS Platform

Add-Ons	
* Support Plus	

Communications

Platform	
* Messages XR Enterprise	

Setup	
* Messages XR Enterprise Setup View a detailed description of what is included in your software package here www.finalsite.com/sowmxre	

The above products, to include but not limited to (modules, integration, design and consulting) will be billed upon contract signature.

Special Provisions:

The following special provisions supercede the Master Terms and Agreements referenced above and within this agreement:

The state of Tennessee has a limitation on multi-year agreements, where the Board of Education is required to approve the funding each year. To accommodate this, this agreement is set up as a five-year agreement comprised of five one-year terms that will auto-renew each year. The client shall have the right to terminate this agreement by giving written notice of cancellation to Finalsite no later than 90 days prior to the end of the then-current one-year term if the Board of Education fails to approve funding for the subsequent year.

Application Services Subscriptions Costs:

Total Cost/Year during the Initial Term of this Order, subject to adjustment for any renewal term as provided below.

Total Setup Cost (USD)
\$ 0

Schedule	Addendum Amount
Period 1 - Aug 01 2025	\$ 15,000
Period 2 - Aug 01 2026	\$ 15,880
Period 3 - Aug 01 2027	\$ 15,880
Period 4 - Aug 01 2028	\$ 15,880
Period 5 - Aug 01 2029	\$ 15,880

B. Additional Terms

1. **Initial Term:** This addendum will take effect on the date this document is signed by both parties and remain in effect for the term stated in the agreement.
2. Unless otherwise specified in the Special Provisions above, this Order Form shall be renewed automatically for successive periods of (0) years (each a "Renewal Term") after the expiration of the Initial Term and any subsequent Renewal Term, unless Customer provides Finalsite, or Finalsite provides Customer, with a written notice to the contrary ninety (90) days prior to the end of the Initial Term or Renewal Term, as applicable.
3. **Effective Date:** Upon execution of this Order.
4. Finalsite standard maintenance and support is included in the subscription fees for Application Services set forth in this Order.
5. All Upgrades and Updates to the Application Services are included in the subscription fees for Application Services set forth in this Order.
6. In addition to Customer's obligations to pay the fees described in the fee table above, Customer agrees to reimburse Finalsite for all travel and other out-of-pocket expenses reasonably incurred by Finalsite in rendering any services described in this Order.

C. Payment Terms

1. All fees for the initial year of this Order shall be due upon execution of this Order. Unless otherwise specified, all dollars (\$) are United States currency. All fees for subsequent years shall be due upon the annual anniversary of the effective date of this Order.
2. Customer shall be invoiced for amounts due in respect of the first year of the Initial Term upon execution of this Order Form.
3. **Sales Tax:** If applicable, a copy of your Sales Tax Direct Pay Certificate or your Sales Tax Exemption Certificate must be returned with this Order Form.

Any SOWs to which links are provided above in Section A, "Pricing Summary," are incorporated into this Order by reference, and any professional services described therein are included as part of your software package. By signing below, Finalsite and Customer each agree to the terms and conditions of this Order, the Master Terms, and any SOWs incorporated by reference. By signing below, Finalsite and Customer each agree to the terms and conditions of this Order and the Master Terms.

On Behalf Of: Murfreesboro City School District
Signature
Name (printed)
Title (printed)
Date

Active Internet Technologies ('Finalsite')
Signature
Name (printed)
Title (printed)
Date

D. Customer Contact Information

Please fill out the following information, which will be used by our deployment & accounting teams.

Billing Contact
Title
Address 2552 S Church St Ste 100
City, State Zip Murfreesboro, TN 37127
Phone
Email

Project Contact
Title
Phone
Email

*Executive Sponsor (Superintendent, Head of School, CFO, etc.)
Title
Email

*The Executive Sponsor should be separate from the Project Contact and is typically the Superintendent, Head of School, Business Manager, CFO, etc.

Agenda Item Title: Agreement with BJB Construction Company for Interior Painting at Discovery School

Board Meeting Date: May 27, 2025

Department: Operations

Presented by: Trey Duke

Board Agenda Category:

- Consent Agenda
- Action Item
- Reports and Information

Requires City Council Approval: Yes No

Summary

Murfreesboro City Schools, in coordination with the City of Murfreesboro Purchasing Department, issued a solicitation for bids for interior painting services at Discovery School. A total of eight (8) bids were received and evaluated based on compliance with the bid specifications and overall cost. BJB Construction Company submitted the lowest and most responsive bid in the amount of \$110,282.00. After review, BJB was determined to meet all necessary qualifications and requirements as outlined in the bid documents.

Staff Recommendation

Approve Agreement with BJB Construction Company for Interior Painting at Discovery School

Fiscal Impact

Total cost of the contract is \$110,282.00 and will be paid through County Shared Bonds.

Connection to MCS's Five-Year Strategic Plan

- Known:** Every student will be *known* through whole-child programs and support.
- Safe:** Every student will be *safe* through equitable access to buildings, facilities, and infrastructure that meets their needs.
- Challenged:** Every student will be *challenged* by learning from highly effective educators and employees.
- Empowered:** Every student will be *empowered* through academic success

**Agreement
for
Interior Painting of Discovery School**

This Agreement is entered into and effective as of _____ (the "Effective Date") by and between the **City of Murfreesboro**, a municipal corporation of the State of Tennessee (the "City"), and **BJB Construction Company, Inc.**, Corporation of the State of Tennessee ("Contractor").

This Agreement consists of the following documents:

- This document
- ITB-42-2025- Interior Painting of Discovery School issued May 6, 2025 (the "Solicitation");
- Contractor's Proposal, dated May 20, 2025 ("Contractor's Proposal");
- Contractor's Price Proposal, May 20, 2025 (the "Price Proposal"); and
- Any properly executed amendments to this Agreement.

In the event of conflicting provisions, all documents will be construed according to the following priorities:

- First, any properly executed amendment or change order to this Agreement (most recent amendment or change order given first priority);
- Second, this Agreement;
- Third, the Solicitation
- Lastly, Contractor's Proposal.

1. Duties and Responsibilities of Contractor.

- a. Scope of Work. Contractor is engaged by the City to provide the equipment, machinery, material, and other items ("Goods") and labor ("Services") to perform the interior painting of Discovery School at 1165 Middle Tennessee Boulevard, Murfreesboro, TN in accordance with the Contractor's Proposal dated May 20, 2025, and the City ITB dated May 6, 2025 and Price Proposal.
- b. Supervision and Superintendence of Work.
 1. Contractor will supervise and direct the work efficiently and with Contractor's best skill and attention. Contractor will be solely responsible for the means, methods, techniques, sequences, and procedures of construction. Contractor will be responsible to see that the finished work complies accurately with the Contract documents.
 2. Contractor will keep on the work site at all times during work progress a competent resident superintendent. The superintendent will be Contractor's representative at the site and shall have authority to act on behalf of Contractor. All communications given to the superintendent shall be as binding as if given to Contractor.
- c. Labor, Materials, and Equipment.
 1. Contractor will furnish all materials, equipment, labor, transportation, construction equipment and machinery, tools, appliances, fuel, and all other incidentals necessary for the execution, testing, initial operation, and completion of the work.
 2. Contractor will perform the Services using personnel with the requisite skill, experience, and qualifications to complete the tasks set forth in the Scope of Work efficiently and in a professional and skillful manner in accordance with generally accepted industry standards for similar services. The Contractor will at all times maintain good discipline and order at the site.
 3. The Goods identified in the Scope of Work will be new, except as otherwise provided it the

Contract documents. If required by the City, Contractor will furnish satisfactory evidence as to the kind and quality of materials and equipment.

4. The Goods identified in the Scope of Work shall be applied, installed, connected, erected, used, cleaned and conditioned in accordance with the instructions of the applicable manufacturer, fabricator or processors, except as otherwise provided in the Contract documents.

d. Warranty and Guarantee.

1. Contractor warrants that the Goods purchased by the City from Contractor pursuant to this Agreement will conform to the specifications set forth in the Scope of Work; that title to the Goods will pass to the City free of and clear of all liens, claims, security interests, or other encumbrances no later than the time of the City's payment for the Goods; and that the Goods do not infringe or misappropriate any third party's patent or other intellectual property rights.
2. With respect to any Goods manufactured by Contractor and sold to the City pursuant to this Agreement, Contractor warrants that such items will be free from any defects in workmanship, material, and design for sixty (60) months from the date of installation or the longest warranty period offered by Contractor to its customer for such items, whichever is longer. In addition, Contractor hereby assigns to the City the Contractor's right, title, benefit, and interest in and to any manufacturer warranty associated with any Goods purchased by the City from Contractor pursuant this Agreement, including the Contractor's right to receive the benefits of and to make claim under any such manufacturer warranty.
3. The Contractor warrants that the Services will be performed in accordance with generally accepted industry standards and warrants the installation of the Goods against defects in workmanship for twelve (12) months from the date of installation or the longest warranty period offered by Contractor to its customer for such work, whichever is longer.
4. The Contractor agrees that all warranties in the Contract documents shall survive acceptance of, delivery of, and payment for, the goods, whether any defects shall be latent or patent, and agrees to indemnify and hold the City harmless from any loss, damage, or other expense, including attorneys' fees, that the City may suffer as a result of the failure of the Goods or workmanship to be as warranted.
5. The warranties set forth in this section are cumulative and shall not exclude or affect the operation of any other warranty or guaranty provided by law or any greater warranty included in Contractor's Proposal.
6. The Contractor agrees to correct any defect in the Goods or workmanship that may develop during the period of such warranties at no cost to the City and to the satisfaction of the City. Upon receipt of notice from City of noncompliance with any warranty set forth in this section or any other warranty provided by law or equity, Contractor shall, at its own cost and expense, within fifteen (15) days: (i) replace or repair the defective or nonconforming Goods and pay for all related expenses, including, but not limited to, transportation charges for the return of the defective or nonconforming goods to the Contractor and the delivery of repaired or replacement Goods to the City; and/or (ii) correct or re-perform the applicable installation work.

e. Subcontractors.

1. Contractor will not employ any subcontractor to perform any of the work required under the Contract documents without first obtaining the written approval of the City's designated representative to employ the subcontractor.

2. Contractor will be fully responsible for all acts and omissions of any subcontractor and of persons directly or indirectly employed by them and of persons for whose acts any of them may be liable to the same extent that Contractor is responsible for the acts and omissions of persons directly employed by Contractor. Nothing in the Contract documents shall create any contractual relationships between any subcontractor and the City or any obligation on the part of the City to pay or to see to the payment of any moneys due any subcontractor, except as may otherwise be required by law. The City may furnish to any subcontractor, to the extent practicable, evidence of amounts paid to Contractor on account of specific work done in accordance with the schedule of values.
 3. Contractor agrees to bind specifically every subcontractor to the applicable terms and conditions of the Contract documents for the benefit of the City.
 4. All work performed for Contractor by a subcontractor shall be pursuant to an appropriate written agreement between Contractor and the subcontractor.
- f. Permits. Contractor will secure and pay for all construction permits and licenses and will pay all governmental charges and inspection fees necessary for the prosecution of the work, which are applicable at the time of Contractor's bid. Contractor will also pay all public utility charges.
- g. Use of Premises.
1. Contractor will confine Contractor's equipment, the storage of materials and equipment and the operations of Contractor's workers to areas permitted by law, ordinances, permits, or the requirements of the Contract documents, and shall not unreasonably encumber the premises with materials or equipment.
 2. Contractor will not load nor permit any part of the structure to be loaded with weights that will endanger the structure, nor will Contractor subject any part of the work to stresses or pressures that will endanger it.
- h. Safety and Protection.
1. Contractor will be responsible for initiating, maintaining and supervising all safety precautions and programs in connection with the work. Contractor will take all necessary precautions for the safety of, and will provide the necessary protection to prevent damage, injury or loss to:
 - a. All employees on the work and other persons who may be affected thereby,
 - b. All the work and all materials or equipment to be incorporated there, whether in storage on or off the site, and
 - c. Other property at the site or adjacent property, including trees, shrubs, lawns, walks, pavements, roadways, structures, and utilities not designated for removal, relocation, or replacement in the course of construction.

Contractor will comply with all applicable laws, ordinances, rules, regulations and order of any public body having jurisdiction for the safety of persons or property or to protect them from damage, injury or loss. Contractor will erect and maintain, as required by the conditions and progress of the work, all necessary safeguards for safety and protection. Contractor will notify the City of adjacent utilities when prosecution of the work may affect them. All damage, injury, or loss to any property referred to in subparagraph (2) or (3) of this section caused directly or indirectly, in whole or in part, by Contractor, any subcontractor or anyone directly or indirectly employed by any of them or anyone for whose acts any of them may be liable, will be remedied by Contractor; except damage or loss attributable to the fault of drawings or specifications or to the acts or omissions of the City

or anyone employed by either of them or anyone for whose acts either of them may be liable, and not attributable, directly or indirectly, in whole or in part, to the fault or negligence of Contractor.

2. Contractor will designate a responsible member of Contractor's organization at the site whose duty shall be the prevention of accidents. This person shall be Contractor's superintendent unless otherwise designated in writing by Contractor to the City.
 - i. Emergencies. In emergencies affecting the safety of persons or the work or property at the site or adjacent property, Contractor, without special instruction or authorization from the City, is obligated to act, at Contractor's discretion, to prevent threatened damage, injury or loss.
 - j. Cleaning Up. Contractor will keep the premises free from accumulations of waste materials, rubbish, and other debris resulting from the work, and at the completion of the work Contractor will remove all waste materials, rubbish and debris from and about the premises as well as all tools, construction equipment and machinery, and surplus materials, and will leave the site clean and ready for occupancy by the City. Contractor will restore to their original condition those portions of the site not designated for alteration by the Contract documents.
 - k. Access to the Work. Representatives of the City will at all times have access to the work. Contractor will provide proper facilities for such access and observation of the work and also for any inspection or testing by others.
 - l. Contractor's Continuing Obligation. Contractor's obligation to perform the work and complete the Project in accordance with the Contract documents shall be absolute. Neither any payment by the City to Contractor under the Contract documents, nor any use or occupancy of the Project or any part by the City, nor any act of acceptance by the City nor any failure to do so, nor any correction of defective work by the City shall constitute acceptance of work not in accordance with the Contract documents.
2. **Term.** The term of this Agreement shall be from the Notice to Proceed to July 21, 2025. All work must be completed by July 21, 2025. Contractor's services may be terminated in whole or in part:
 - a. Upon 30-day prior notice, for the convenience of the City.
 - b. For the convenience of Contractor, provided that Contractor notifies the City in writing of its intent to terminate under this paragraph at least 30 days prior to the effective date of the termination.
 - c. For cause, by either party where the other party fails in any material way to perform its obligations under this Agreement. Termination under this subsection is subject to the condition that the terminating party notifies the other party of its intent to terminate, stating with reasonable specificity the grounds therefore, and the other party fails to remedy the problem within 15 days after receiving the notice.
 - d. Should Contractor fail to fulfill in a timely and proper manner its obligations under this Agreement or if it should violate any of the terms of this Agreement, the City has the right to immediately terminate the Agreement. Such termination does not relieve Contractor of any liability to the City for damages sustained by virtue of any breach by Contractor.
 - e. Should the appropriation for Contractor's work be withdrawn or modified, the City has the right to terminate the Agreement immediately upon written notice to Contractor.
3. **Price; Compensation; Method of Payment.** Contractor will be compensated upon the delivery and acceptance of the goods and services specified in Contractor's bid submitted in response to ITB-42-2025, which reflects a **total price of \$110,282.00. This total includes a**

5% Owner's Contingency of \$5,252.00, to be used solely at the Owner's discretion. Any compensation due Contractor under the Agreement shall be made upon submittal of an invoice after performance of the portion of the services which each payment represents. The City agrees to pay Contractor after goods and/or services have been received, accepted, and properly invoiced as indicated in the Agreement and/or purchase order. The final payment shall be made only after Contractor has completely performed its duties under this Contract and the work has been accepted by the City and all work has been approved by an inspector from Facilities Maintenance, if applicable. Invoices must bear the purchase order number. Final payment shall not be made until after performance is complete. All invoices should be sent to: accountspayable@murfreesborotn.gov.

4. **Liquidated Damages.** Whereas the Owner will suffer loss of use if the project is not complete on or before July 21, 2025, the Contractor and their Surety shall be liable for and shall pay to the Owner the sum of Two Hundred Dollars (\$200.00) as fixed and agreed liquidated damages for each calendar day of delay (in excess of the Contract Completion Date established herein) until the work is substantially complete. The City representative or architect shall verify date that work is substantially complete.
5. **Insurance.** Contractor must maintain commercial general liability insurance for bodily injury and property damage, automobile liability insurance, and workers' compensation insurance as required by the State of Tennessee and as specified in Exhibit A hereto. Contractor must name the City and the City of Murfreesboro as an additional insured Contractor must notify the City within five days if the insurance policy is renewed, cancelled, or altered in any manner and provide written documentation of such alteration.
6. **Payment and Performance Bonds.** Contractor must furnish a Performance Bond and a Payment Bond each in the amounts of 100% of the Contract Sum covering the faithful performance and completion of the Agreement and the payment of all obligations arising there under. Bonds shall be issued on a form acceptable to the City by a surety licensed in the State of Tennessee. The Contractor must provide evidence of Bonds prior to the beginning of work. If the Performance and Payment Bonds are not furnished within 30 days of Notice of Award, the Contractor Bid Bond may be forfeited, and the Contract may be awarded to an alternate contractor. The City will require the Contractor to increase the Performance and Payment Bonds to accommodate Change Orders that individually or cumulatively exceed 10% of the original Contract Sum. The Contractor shall furnish to the City and keep in force during the term of the Contract, performance and labor and material payment bonds guaranteeing that the Contractor will perform its obligations under the Contract and will pay for all labor and materials furnished for the Work. Upon the request of any person or entity appearing to be a potential beneficiary of bonds covering payment of obligations arising under the Agreement, the Contractor shall promptly furnish a copy of the bonds or shall permit a copy to be made.
7. **Indemnification.**
 - a. Contractor must indemnify, defend, and hold harmless the City, its officers, agents and employees from any claims, penalties, damages, costs and attorney fees ("Expenses") arising from injuries or damages resulting from, in part or in whole, the negligent or intentional acts or omissions of contractor, its officers, employees and/or agents, including its subcontractors or independent contractors, in connection with the performance of this Agreement, and, Expenses arising from any failure of Contractor, its officers, employees and/or agents, including its subcontractors or independent contractors, to observe applicable laws, including, but not limited to, labor laws and minimum wage laws.

- b. Pursuant to Tennessee Attorney General Opinion 93-01, the City will not indemnify, defend or hold harmless in any fashion Contractor from any claims arising from any failure, regardless of any language in any attachment or other document that Contractor may provide.

8. Notices.

Notice of assignment of any rights to money due to Contractor under this Agreement must be mailed first class mail or hand delivered to the following:

If to the City of Murfreesboro:	If to Contractor:
City Manager	BJB Construction Company, Inc.
City of Murfreesboro	Attn: Nathaniel Benbow
111 West Vine Street	1373 Holly Tree Gap Road
Murfreesboro, TN 37130	Brentwood, TN 37027
	nathan@bjbconstruction.com

- 9. Maintenance of Records.** Contractor must maintain documentation for all charges against the City. The books, records, and documents of Contractor, insofar as they relate to work performed or money received under the Agreement, must be maintained for a period of three full years from the date of final payment and will be subject to audit, at any reasonable time and upon reasonable notice by the City or its duly appointed representatives. Accounting records must be maintained in accordance with the Generally Accepted Accounting Principles.
- 10. Modification.** This Agreement may be modified only by written amendment executed by all parties and their signatories hereto.
- 11. Relationship of the Parties.** Nothing herein may in any way be construed or intended to create a partnership or joint venture between the parties or to create the relationship of principal and agent between or among any of the parties. None of the parties hereto may hold itself out in a manner contrary to the terms of this paragraph. No party becomes liable for any representation, act, or omission of any other party contrary to this section.
- 12. Waiver.** No waiver of any provision of this Agreement affects the right of any party thereafter to enforce such provision or to exercise any right or remedy available to it in the event of any other default.
- 13. Employment.** Contractor may not subscribe to any personnel policy which permits or allows for the promotion, demotion, employment, dismissal or laying off of any individual due to race, creed, color, national origin, age, sex, veteran status, or any other status or class protected under federal or state law or which is in violation of applicable laws concerning the employment of individuals with disabilities.
- 14. Non-Discrimination.** It is the policy of the City not to discriminate on the basis of age, race, sex, color, national origin, veteran status, disability, or other status or class protected under federal or state law in its hiring and employment practices, or in admission to, access to, or operation of its programs, services, and activities. With regard to all aspects of this Agreement, Contractor certifies and warrants it will comply with this policy. No person may be excluded from participation in, be denied benefits of, be discriminated against in the admission or access to, or be discriminated against in treatment or employment in the City's contracted programs or activities, on the grounds of handicap and/or disability, age, race, color, religion, sex, national origin, or any other classification protected by federal or Tennessee State Constitutional or statutory law; nor may they be excluded from participation in, be denied benefits of, or be otherwise subjected to discrimination in the performance of contracts with

the City or in the employment practices of the City's Contractors. Accordingly, all proposers entering into contracts with the City may upon request be required to show proof of such nondiscrimination and to post in conspicuous places that are available to all employees and applicants, notices of nondiscrimination.

15. **Confidentiality of Records.** All educational records created, disclosed or maintained pursuant to the terms of this contract are confidential and shall be created, disclosed and maintained pursuant to the provisions of Family Educational Right to Privacy Act, also known as FERPA (20 U.S.C.A. s1232g), its regulations and Board Policy.
16. **Background Checks.** Contractor shall comply with T.C.A. §49-5-413, which requires all contractors to facilitate a criminal history records check conducted by the Tennessee Bureau of Investigation and the Federal Bureau of Investigation for each employee prior to permitting the employee to have contact with students or enter school grounds when students are present.
17. **Tobacco Free Policy.** Pursuant to Murfreesboro City School Board Policy 1.803, the use of tobacco and tobacco products, including smokeless tobacco, are prohibited on all of the Murfreesboro City School property.
18. **Gratuities and Kickbacks.** It is a breach of ethical standards for any person to offer, give or agree to give any employee or former employee, or for any employee or former employee to solicit, demand, accept or agree to accept from another person, a gratuity or an offer of employment in connection with any decision, approval, disapproval, recommendation, preparation of any part of a program requirement or a purchase request, influencing the content of any specification or procurement standard, rendering of advice, investigation, auditing or in any other advisory capacity in any proceeding or application, request for ruling, determination, claim or controversy or other particular matter, pertaining to any program requirement of a contract or subcontract or to any solicitation or proposal therewith. It is a breach of ethical standards for any payment, gratuity or offer of employment to be made by or on behalf of a subcontractor under a contract to the prime contractor or higher tier subcontractor or a person associated therewith, as an inducement for the award of a subcontract or order. Breach of the provisions of this paragraph is, in addition to a breach of this Agreement, a breach of ethical standards which may result in civil or criminal sanction and/or debarment or suspension from being a contractor or subcontractor under the City.
19. **Assignment.** The provisions of this Agreement inure to the benefit of and are binding upon the respective successors and assignees of the parties hereto. Except for the rights of money due to Contractor under this Agreement, neither this Agreement nor any of the rights and obligations of Contractor hereunder may be assigned or transferred in whole or in part without the prior written consent of the City. Any such assignment or transfer does not release Contractor from its obligations hereunder.
20. **Integration.** This Agreement sets forth the entire agreement between the parties with respect to the subject matter hereof and governs the respective duties and obligations of the parties.
21. **Force Majeure.** No party has any liability to the other hereunder by reason of any delay or failure to perform any obligation or covenant if the delay or failure to perform is occasioned by *force majeure*, meaning any act of God, storm, fire, casualty, unanticipated work stoppage, strike, lockout, labor dispute, civil disturbance, riot, war, national emergency, act of public enemy, or other cause of similar or dissimilar nature beyond its control.
22. **Governing Law and Venue.** The validity, construction and effect of this Agreement and any and all extensions or modifications thereof are governed by the laws of the state of Tennessee regardless of choice of law doctrine or provision in any attachment or other document that

Contractor may provide. Any action between the parties arising from this agreement may only be filed in the courts of Rutherford County, Tennessee.

23. **Severability.** Should any provision of this Agreement be declared to be invalid by any court of competent jurisdiction, such provision will be severed and not affect the validity of the remaining provisions of this Agreement.
24. **Attorney Fees.** In the event any party takes legal action to enforce any provision of the Agreement, should the City prevail, Contractor will pay all expenses of such action including attorney fees, expenses, and costs at all stages of the litigation and dispute resolution.
25. **Iran Divestment Act of Tennessee.** By submission of the Contractor's Bid, Contractor certifies, under penalty of perjury, that to the best of its knowledge and belief that Contractor is not on the list created pursuant to Tenn. Code Ann. §12-12-106.
26. **Non-Boycott of Israel.** By submission of the Contractor's Bid, Contractor certifies, under penalty of perjury, that to the best of its knowledge and belief that each supplier is not boycotting Israel pursuant to Tenn. Code Ann. § 12-4-119 and will not boycott Israel during the term of contract. This applies to contracts of \$250,000 or more and to contractors with ten (10) or more employees.
27. **Effective Date.** This Agreement is not binding upon the parties until signed by each of the Contractor and authorized representatives of the City and is thereafter effective as of the date set forth above.

IN WITNESS WHEREOF, the parties enter into this agreement as of the Effective Date first listed above.

CITY OF MURFREESBORO, TENNESSEE

BJB CONSTRUCTION COMPANY, INC.

By: _____
Shane McFarland, Mayor

By: _____
Nathaniel Benbow, Estimator/Principal Officer

Approved as to form:

Adam F. Tucker, City Attorney

Exhibit A
Insurance Requirements

Contractor must, as a material obligation to the Owner and a condition precedent to any payment otherwise due to Contractor, furnish and maintain, and cause its Subcontractors to furnish and maintain, insurance in accordance with the provisions of this Exhibit.

Contractor must secure and maintain without interruption, from the date of commencement of the Work until the later of the date of Final Completion, the date of final payment, or the date until which this Agreement requires any coverage to be maintained after final payment, policies of commercial general liability, commercial auto, umbrella/excess, workers' compensation and employer's liability insurance, providing the following coverages, limits and endorsements:

1. Commercial General Liability Insurance.

- 1.1 The CGL policy must be written on an occurrence basis, on ISO form CG 001 or its equivalent, providing coverage for bodily injury, broad form property damage, personal injury (including coverage for contractual and employee acts), contractual liability, incidental professional liability, the hazards commonly referred to as XCU, and products and completed operations, with a combined single limit of liability of not less than \$1,000,000 for each occurrence applicable to the Work, and an annual aggregate limit of liability of not less than \$1,000,000 applicable solely to the Work, and meeting all other requirements of this Exhibit.
- 1.2 The general liability insurance may be accomplished with a combination of a general liability and an excess/umbrella liability policy.
- 1.3 Each general liability policy must be endorsed or written to:
 - a. Include the per project aggregate endorsement;
 - b. Name as additional insureds the following: the City of Murfreesboro and its elected officials, officers, employees, representatives and agents (collectively, the "Additional Insureds");
 - c. Stipulate that the insurance afforded by the policies furnished by Contractor will be primary insurance and that any insurance, self-insured retention, deductibles, or risk retention programs maintained or participated in by the Additional Insureds, or their agents, officials or employees will be excess and not contributory to the liability insurance furnished by Contractor and by its Subcontractors;
 - d. Includes a severability of interest clause; and
 - e. Waive all rights of recovery against the Additional Insureds.

- 2. Workers' Compensation Insurance.** Workers' Compensation policy must meet all Tennessee statutory requirements, including Employers' Liability Insurance with limits of at least \$ 1,000,000 per accident or disease per employee, both policies endorsed to waive subrogation against the Additional Insureds.

3. **Auto Liability Insurance**

- 3.1 Commercial auto liability must be carried with minimum combined single limit of \$1,000,000 per occurrence.
- 3.2 This policy must include a duty to defend and cover all owned, non-owned, leased, hired, assigned or borrowed vehicles.
- 3.3 This policy must be endorsed, by specific or blanket endorsement, to name the Additional Insureds as such, stipulate that any insurance carried by the Additional Insureds must be excess and not contributory, and to waive subrogation against the Additional Insureds.

4. **Term of Coverage**

- 4.1 The products and completed operations liability coverage required by this Agreement must extend for a period of not less than five years after the earlier of Final Payment for the Work, or the termination of the Agreement (the "Completed Operations Term").
- 4.2 If at any time during the Completed Operations Term Contractor cannot obtain equivalent coverage by replacement or renewal, Contractor must acquire a tail policy prior to expiration of the existing policy that will extend coverage until the end of the Completed Operations Term.
- 4.3 Contractor will furnish certificates of insurance and other evidence that the Owner may reasonably require during the Completed Operations Term to establish compliance with the requirements of this paragraph.
- 4.4 All other policies of insurance must be maintained continuously in force from commencement of the Work until the date of Final Payment.

5. **Subcontractor and Lower-Tier Entities Insurance Requirements**

- 5.1 Contractor must require all of Contractor's Subcontractors and must require its Subcontractors to require their Lower Tier Entities, as a condition of working on the Project, and of receiving payment, to:
 - a. Purchase and maintain Commercial General Liability, Workers' Compensation and Employer's Liability, and Automotive insurance policies, with the same coverages, endorsements, terms of coverage and other provisions as are required of Contractor under by this Exhibit, **EXCEPT THAT** the combined coverage limits of the general liability insurance to be furnished by Lower Tier Entities must be \$ 1,000,000 per occurrence, and \$ 1,000,000 as the annual aggregate limit; and
 - b. Timely furnish to the Owner proper certificates, endorsements, copies of declarations pages, and other documents necessary to establish the Subcontractor's compliance with this Exhibit.
 - c. The Lower Tier Entities' general liability policy must also be endorsed to provide the policy must be primary insurance, the general liability insurance furnished by Contractor must be the secondary and non-contributory, and any insurance carried by the Additional Insureds must be excess, tertiary and non-contributory to the insurance furnished by Contractor and Subcontractor.

- d. The Owner has the right to inspect and copy all such certificates, endorsements, or other proof at any reasonable time.

6. Other Policy Provisions. Each policy to be furnished by Contractor and each Subcontractor must:

- 6.1 Be issued by an insurance carrier having a rating from A.M. Best Company of at least A-VII or better;
- 6.2 Provide that attorney's fees are outside of the policy's limits and be unlimited;
- 6.3 Include the Project per aggregate endorsement;
- 6.4 Waive all rights of subrogation against the Owner;
- 6.5 Provide a Certificate that contains a provision that coverages afforded under the policies will not be canceled, allowed to expire, or reduced in amount until at least thirty (30) days' prior written Notice has been given to the Owner; and
- 6.6 Be otherwise satisfactory to the Owner. The Owner agrees to consider alternatives to the requirements imposed by this Exhibit but only to the extent that the Owner is satisfied the insurance is not commercially available to the insured. In such event, the Owner has the right to set conditions for such waiver, including, but not limited to, additional indemnities, and the request that the Owner be a loss-payee under the policy.

7. Certificates and Endorsements

- 7.1 Within 10 days after the execution of this Agreement, Contractor must provide the Owner with certificates and endorsements;
- 7.2 Upon the Owner request, Contractor must provide the Owner with certificates and endorsements from each of its Subcontractors, in all cases evidencing compliance by Contractor, each Subcontractor, and Lower Tier Entities with the requirements of this Exhibit together with letters from the respective carriers (including, but not limited to, the Errors and Omissions insurance carriers) that there are no known or pending claims or incidents which have resulted in the establishment of a reserve or otherwise have reduced the amount of coverage potentially available to the Owner under the policy and that available coverage has not been reduced because of revised limits or payments made (or, in the event such representations cannot be given, Contractor, its Subcontractors, and its Lower Tier Entities must furnish the particulars thereof to the Owner.
- 7.3 If any of the foregoing insurance coverages are required to remain in force after Final Completion, Contractor must submit an additional certificate evidencing continuation of such coverage with its application for final payment.

8. Reduction in Coverage. Contractor must promptly inform the Owner of any reduction of coverage resulting from revised limits, claims paid, or both and must require its Subcontractors and Lower Tier Entities to promptly inform Contractor of same. The Owner has the right to require Contractor or the applicable Subcontractor to obtain supplemental or replacement coverage to offset such reduced coverage, at the sole cost or expense of Contractor or the applicable Subcontractor.

9. Suppliers and Materialmen Coverages

- 9.1 Contractor will endeavor to cause all suppliers and materialmen to deliver any equipment, machinery or other goods FOB Site.
- 9.2 With respect to any equipment, machinery or other goods for which the Owner or Contractor has paid a deposit, Contractor will cause the respective suppliers and materialmen to maintain personal property insurance in an amount equal to the value of such equipment, machinery or other goods (but in no event less than the amount of the applicable deposit) during fabrication, storage and transit, naming the Owner and Contractor as loss payee as their interests appear.

10. Condition Precedent to Starting Work

- 10.1 Prior to, and as a condition of its right to begin performing any Work on the Site, Contractor and each Subcontractor and Lower Tier Entities must deliver to the Owner certificates of insurance representing that the required insurance is in force, together with the additional insured endorsements and waivers of subrogation required above, and such other proof satisfactory to the Owner that the required insurance is in place; together with the original of each bond required under this Agreement. Contractor and each Subcontractor and Lower Tier Entities hereby authorize the Owner to communicate directly with the respective insurance agents, brokers and/or carriers and sureties to verify their insurance and bond coverage;
- 10.2 The Owner is under no obligation or duty to make any such inquiry and the Owner is entitled to rely on any proofs of insurance tendered by Contractor or its Subcontractors and Lower Tier Entities. The Owner's acceptance of any proof of insurance and bonds offered by Contractor or any Subcontractor or Lower Tier Entities will not be deemed a waiver of the obligations of Contractor and Subcontractors and Lower Tier Entities to furnish the insurance and bonds required by this Exhibit.

- 11. **Additional Proofs of Insurance.** Contractor must, within 10 days after request, provide the Owner with certified copies of all policies and endorsements obtained in compliance with this Agreement.
- 12. **Indemnity.** The fact that Contractor and its Subcontractors are required by this Agreement to purchase and maintain insurance in no way limits or restricts any other obligations or duties Contractor and its Subcontractors and Lower Tier Entities may have to indemnify, defend or hold harmless the Owner and the other Additional Insureds from and against any and all demands, liabilities, losses or expenses of whatever kind or nature.
- 13. **Interpretation.** In the event of any inconsistency between the provisions of this Exhibit and those of the other provisions of the Agreement, the terms of this Exhibit will govern.

Agenda Item Title: Agreement with CMG Contractors for Interior Painting at Hobgood Elementary School

Board Meeting Date: May 27, 2025

Department: Operations

Presented by: Trey Duke

Board Agenda Category:

- Consent Agenda
- Action Item
- Reports and Information

Requires City Council Approval: Yes No

Summary

Murfreesboro City Schools, in coordination with the City of Murfreesboro Purchasing Department, issued a solicitation for bids for interior painting services at Hobgood Elementary. A total of eight (8) bids were received and evaluated based on compliance with the bid specifications and overall cost. CMG Contractors submitted the lowest and most responsive bid in the amount of \$103,000. After review, CMG was determined to meet all necessary qualifications and requirements as outlined in the bid documents.

Staff Recommendation

Approve Agreement with CMG Contractors for Interior Painting at Hobgood Elementary School

Fiscal Impact

Total cost of the contract is \$103,000.00 and will be paid through County Shared Bonds.

Connection to MCS's Five-Year Strategic Plan

- Known:** Every student will be *known* through whole-child programs and support.
- Safe:** Every student will be *safe* through equitable access to buildings, facilities, and infrastructure that meets their needs.
- Challenged:** Every student will be *challenged* by learning from highly effective educators and employees.
- Empowered:** Every student will be *empowered* through academic success

**Agreement
for
Interior Painting of Hobgood Elementary**

This Agreement is entered into and effective as of _____ (the "Effective Date") by and between the **City of Murfreesboro**, a municipal corporation of the State of Tennessee (the "City"), and **CMG Contractors, Inc.**, a Corporation company of the State of Tennessee ("Contractor").

This Agreement consists of the following documents:

- This document
- ITB-43-2025- Interior Painting of Hobgood Elementary issued May 6, 2025 (the "Solicitation");
- Contractor's Proposal, dated May 20, 2025 ("Contractor's Proposal");
- Contractor's Price Proposal, May 20, 2025, (the "Price Proposal"); and
- Any properly executed amendments to this Agreement.

In the event of conflicting provisions, all documents will be construed according to the following priorities:

- First, any properly executed amendment or change order to this Agreement (most recent amendment or change order given first priority);
- Second, this Agreement;
- Third, the Solicitation
- Lastly, Contractor's Proposal.

1. Duties and Responsibilities of Contractor.

- a. Scope of Work. Contractor is engaged by the City to provide the equipment, machinery, material, and other items ("Goods") and labor ("Services") to perform the interior painting of Hobgood Elementary at 307 Baird Lane, Murfreesboro, TN in accordance with the Contractor's Proposal dated May 20, 2025, and the City ITB dated May 6, 2025, and Price Proposal.
- b. Supervision and Superintendence of Work.
 1. Contractor will supervise and direct the work efficiently and with Contractor's best skill and attention. Contractor will be solely responsible for the means, methods, techniques, sequences, and procedures of construction. Contractor will be responsible to see that the finished work complies accurately with the Contract documents.
 2. Contractor will keep on the work site at all times during work progress a competent resident superintendent. The superintendent will be Contractor's representative at the site and shall have authority to act on behalf of Contractor. All communications given to the superintendent shall be as binding as if given to Contractor.
- c. Labor, Materials, and Equipment.
 1. Contractor will furnish all materials, equipment, labor, transportation, construction equipment and machinery, tools, appliances, fuel, and all other incidentals necessary for the execution, testing, initial operation, and completion of the work.
 2. Contractor will perform the Services using personnel with the requisite skill, experience, and qualifications to complete the tasks set forth in the Scope of Work efficiently and in a professional and skillful manner in accordance with generally accepted industry standards for similar services. The Contractor will at all times maintain good discipline and order at the site.
 3. The Goods identified in the Scope of Work will be new, except as otherwise provided in the Contract documents. If required by the City, Contractor will furnish satisfactory evidence

as to the kind and quality of materials and equipment.

4. The Goods identified in the Scope of Work shall be applied, installed, connected, erected, used, cleaned and conditioned in accordance with the instructions of the applicable manufacturer, fabricator or processors, except as otherwise provided in the Contract documents.

d. Warranty and Guarantee.

1. Contractor warrants that the Goods purchased by the City from Contractor pursuant to this Agreement will conform to the specifications set forth in the Scope of Work; that title to the Goods will pass to the City free of and clear of all liens, claims, security interests, or other encumbrances no later than the time of the City's payment for the Goods; and that the Goods do not infringe or misappropriate any third party's patent or other intellectual property rights.
2. With respect to any Goods manufactured by Contractor and sold to the City pursuant to this Agreement, Contractor warrants that such items will be free from any defects in workmanship, material, and design for sixty (60) months from the date of installation or the longest warranty period offered by Contractor to its customer for such items, whichever is longer. In addition, Contractor hereby assigns to the City the Contractor's right, title, benefit, and interest in and to any manufacturer warranty associated with any Goods purchased by the City from Contractor pursuant this Agreement, including the Contractor's right to receive the benefits of and to make claim under any such manufacturer warranty.
3. The Contractor warrants that the Services will be performed in accordance with generally accepted industry standards and warrants the installation of the Goods against defects in workmanship for twelve (12) months from the date of installation or the longest warranty period offered by Contractor to its customer for such work, whichever is longer.
4. The Contractor agrees that all warranties in the Contract documents shall survive acceptance of, delivery of, and payment for, the goods, whether any defects shall be latent or patent, and agrees to indemnify and hold the City harmless from any loss, damage, or other expense, including attorneys' fees, that the City may suffer as a result of the failure of the Goods or workmanship to be as warranted.
5. The warranties set forth in this section are cumulative and shall not exclude or affect the operation of any other warranty or guaranty provided by law or any greater warranty included in Contractor's Proposal.
6. The Contractor agrees to correct any defect in the Goods or workmanship that may develop during the period of such warranties at no cost to the City and to the satisfaction of the City. Upon receipt of notice from City of noncompliance with any warranty set forth in this section or any other warranty provided by law or equity, Contractor shall, at its own cost and expense, within fifteen (15) days: (i) replace or repair the defective or nonconforming Goods and pay for all related expenses, including, but not limited to, transportation charges for the return of the defective or nonconforming goods to the Contractor and the delivery of repaired or replacement Goods to the City; and/or (ii) correct or re-perform the applicable installation work.

e. Subcontractors.

1. Contractor will not employ any subcontractor to perform any of the work required under the Contract documents without first obtaining the written approval of the City's designated representative to employ the subcontractor.

2. Contractor will be fully responsible for all acts and omissions of any subcontractor and of persons directly or indirectly employed by them and of persons for whose acts any of them may be liable to the same extent that Contractor is responsible for the acts and omissions of persons directly employed by Contractor. Nothing in the Contract documents shall create any contractual relationships between any subcontractor and the City or any obligation on the part of the City to pay or to see to the payment of any moneys due any subcontractor, except as may otherwise be required by law. The City may furnish to any subcontractor, to the extent practicable, evidence of amounts paid to Contractor on account of specific work done in accordance with the schedule of values.
 3. Contractor agrees to bind specifically every subcontractor to the applicable terms and conditions of the Contract documents for the benefit of the City.
 4. All work performed for Contractor by a subcontractor shall be pursuant to an appropriate written agreement between Contractor and the subcontractor.
- f. Permits. Contractor will secure and pay for all construction permits and licenses and will pay all governmental charges and inspection fees necessary for the prosecution of the work, which are applicable at the time of Contractor's bid. Contractor will also pay all public utility charges.
- g. Use of Premises.
1. Contractor will confine Contractor's equipment, the storage of materials and equipment and the operations of Contractor's workers to areas permitted by law, ordinances, permits, or the requirements of the Contract documents, and shall not unreasonably encumber the premises with materials or equipment.
 2. Contractor will not load nor permit any part of the structure to be loaded with weights that will endanger the structure, nor will Contractor subject any part of the work to stresses or pressures that will endanger it.
- h. Safety and Protection.
1. Contractor will be responsible for initiating, maintaining and supervising all safety precautions and programs in connection with the work. Contractor will take all necessary precautions for the safety of, and will provide the necessary protection to prevent damage, injury or loss to:
 - a. All employees on the work and other persons who may be affected thereby,
 - b. All the work and all materials or equipment to be incorporated there, whether in storage on or off the site, and
 - c. Other property at the site or adjacent property, including trees, shrubs, lawns, walks, pavements, roadways, structures, and utilities not designated for removal, relocation, or replacement in the course of construction.

Contractor will comply with all applicable laws, ordinances, rules, regulations and order of any public body having jurisdiction for the safety of persons or property or to protect them from damage, injury or loss. Contractor will erect and maintain, as required by the conditions and progress of the work, all necessary safeguards for safety and protection. Contractor will notify the City of adjacent utilities when prosecution of the work may affect them. All damage, injury, or loss to any property referred to in subparagraph (2) or (3) of this section caused directly or indirectly, in whole or in part, by Contractor, any subcontractor or anyone directly or indirectly employed by any of them or anyone for whose acts any of them may be liable, will be remedied by Contractor; except damage or loss attributable to the fault of drawings or specifications or to the acts or omissions of the City

or anyone employed by either of them or anyone for whose acts either of them may be liable, and not attributable, directly or indirectly, in whole or in part, to the fault or negligence of Contractor.

2. Contractor will designate a responsible member of Contractor's organization at the site whose duty shall be the prevention of accidents. This person shall be Contractor's superintendent unless otherwise designated in writing by Contractor to the City.
 - i. Emergencies. In emergencies affecting the safety of persons or the work or property at the site or adjacent property, Contractor, without special instruction or authorization from the City, is obligated to act, at Contractor's discretion, to prevent threatened damage, injury or loss.
 - j. Cleaning Up. Contractor will keep the premises free from accumulations of waste materials, rubbish, and other debris resulting from the work, and at the completion of the work Contractor will remove all waste materials, rubbish and debris from and about the premises as well as all tools, construction equipment and machinery, and surplus materials, and will leave the site clean and ready for occupancy by the City. Contractor will restore to their original condition those portions of the site not designated for alteration by the Contract documents.
 - k. Access to the Work. Representatives of the City will at all times have access to the work. Contractor will provide proper facilities for such access and observation of the work and also for any inspection or testing by others.
 - l. Contractor's Continuing Obligation. Contractor's obligation to perform the work and complete the Project in accordance with the Contract documents shall be absolute. Neither any payment by the City to Contractor under the Contract documents, nor any use or occupancy of the Project or any part by the City, nor any act of acceptance by the City nor any failure to do so, nor any correction of defective work by the City shall constitute acceptance of work not in accordance with the Contract documents.
2. **Term**. The term of this Agreement shall be from the date of the Notice to Proceed to July 21, 2025. All work **must be completed** by July 21, 2025. Contractor's services may be terminated in whole or in part:
 - a. Upon 30-day prior notice, for the convenience of the City.
 - b. For the convenience of Contractor, provided that Contractor notifies the City in writing of its intent to terminate under this paragraph at least 30 days prior to the effective date of the termination.
 - c. For cause, by either party where the other party fails in any material way to perform its obligations under this Agreement. Termination under this subsection is subject to the condition that the terminating party notifies the other party of its intent to terminate, stating with reasonable specificity the grounds therefore, and the other party fails to remedy the problem within 15 days after receiving the notice.
 - d. Should Contractor fail to fulfill in a timely and proper manner its obligations under this Agreement or if it should violate any of the terms of this Agreement, the City has the right to immediately terminate the Agreement. Such termination does not relieve Contractor of any liability to the City for damages sustained by virtue of any breach by Contractor.
 - e. Should the appropriation for Contractor's work be withdrawn or modified, the City has the right to terminate the Agreement immediately upon written notice to Contractor.
3. **Price; Compensation; Method of Payment**. Contractor will be compensated upon the delivery and acceptance of the goods and services specified in Contractor's bid submitted in response to ITB-43-2025, which reflects a **total price of \$103,000.00. This includes a 5% Owners Contingency of \$4,901.72, to be used solely at the Owner's discretion.** Any compensation due Contractor under the Agreement shall be made upon submittal of an

invoice after performance of the portion of the services which each payment represents. The City agrees to pay Contractor after goods and/or services have been received, accepted, and properly invoiced as indicated in the Agreement and/or purchase order. The final payment shall be made only after Contractor has completely performed its duties under this Contract and the work has been accepted by the City and all work has been approved by an inspector from Facilities Maintenance, if applicable. Invoices must bear the purchase order number. Final payment shall not be made until after performance is complete. All invoices should be sent to: accountspayable@murfreesborotn.gov.

4. **Liquidated Damages.** Whereas the Owner will suffer loss of use if the project is not complete on or before July 21, 2025, the Contractor and their Surety shall be liable for and shall pay to the Owner the sum of Two Hundred Dollars (\$200.00) as fixed and agreed liquidated damages for each calendar day of delay (in excess of the Contract Completion Date established herein) until the work is substantially complete. The City representative or architect shall verify date that work is substantially complete.
5. **Insurance.** Contractor must maintain commercial general liability insurance for bodily injury and property damage, automobile liability insurance, and workers' compensation insurance as required by the State of Tennessee and as specified in Exhibit A hereto. Contractor must name the City and the City of Murfreesboro as an additional insured Contractor must notify the City within five days if the insurance policy is renewed, cancelled, or altered in any manner and provide written documentation of such alteration.
6. **Payment and Performance Bonds.** Contractor must furnish a Performance Bond and a Payment Bond each in the amounts of 100% of the Contract Sum covering the faithful performance and completion of the Agreement and the payment of all obligations arising there under. Bonds shall be issued on a form acceptable to the City by a surety licensed in the State of Tennessee. The Contractor must provide evidence of Bonds prior to the beginning of work. If the Performance and Payment Bonds are not furnished within 30 days of Notice of Award, the Contractor Bid Bond may be forfeited, and the Contract may be awarded to an alternate contractor. The City will require the Contractor to increase the Performance and Payment Bonds to accommodate Change Orders that individually or cumulatively exceed 10% of the original Contract Sum. The Contractor shall furnish to the City and keep in force during the term of the Contract, performance and labor and material payment bonds guaranteeing that the Contractor will perform its obligations under the Contract and will pay for all labor and materials furnished for the Work. Upon the request of any person or entity appearing to be a potential beneficiary of bonds covering payment of obligations arising under the Agreement, the Contractor shall promptly furnish a copy of the bonds or shall permit a copy to be made.
7. **Indemnification.**
 - a. Contractor must indemnify, defend, and hold harmless the City, its officers, agents and employees from any claims, penalties, damages, costs and attorney fees ("Expenses") arising from injuries or damages resulting from, in part or in whole, the negligent or intentional acts or omissions of contractor, its officers, employees and/or agents, including its subcontractors or independent contractors, in connection with the performance of this Agreement, and, Expenses arising from any failure of Contractor, its officers, employees and/or agents, including its subcontractors or independent contractors, to observe applicable laws, including, but not limited to, labor laws and minimum wage laws.
 - b. Pursuant to Tennessee Attorney General Opinion 93-01, the City will not indemnify, defend or hold harmless in any fashion Contractor from any claims arising from any failure,

regardless of any language in any attachment or other document that Contractor may provide.

8. Notices.

Notice of assignment of any rights to money due to Contractor under this Agreement must be mailed first class mail or hand delivered to the following:

If to the City of Murfreesboro:	If to Contractor:
City Manager	CMG Contractors, Inc.
City of Murfreesboro	Attn: Marcus Hayes
111 West Vine Street	2718 Scovel Street
Murfreesboro, TN 37130	Nashville, TN 37208
	marcus@cmgnashville.com

- 9. Maintenance of Records.** Contractor must maintain documentation for all charges against the City. The books, records, and documents of Contractor, insofar as they relate to work performed or money received under the Agreement, must be maintained for a period of three full years from the date of final payment and will be subject to audit, at any reasonable time and upon reasonable notice by the City or its duly appointed representatives. Accounting records must be maintained in accordance with the Generally Accepted Accounting Principles.
- 10. Modification.** This Agreement may be modified only by written amendment executed by all parties and their signatories hereto.
- 11. Relationship of the Parties.** Nothing herein may in any way be construed or intended to create a partnership or joint venture between the parties or to create the relationship of principal and agent between or among any of the parties. None of the parties hereto may hold itself out in a manner contrary to the terms of this paragraph. No party becomes liable for any representation, act, or omission of any other party contrary to this section.
- 12. Waiver.** No waiver of any provision of this Agreement affects the right of any party thereafter to enforce such provision or to exercise any right or remedy available to it in the event of any other default.
- 13. Employment.** Contractor may not subscribe to any personnel policy which permits or allows for the promotion, demotion, employment, dismissal or laying off of any individual due to race, creed, color, national origin, age, sex, veteran status, or any other status or class protected under federal or state law or which is in violation of applicable laws concerning the employment of individuals with disabilities.
- 14. Non-Discrimination.** It is the policy of the City not to discriminate on the basis of age, race, sex, color, national origin, veteran status, disability, or other status or class protected under federal or state law in its hiring and employment practices, or in admission to, access to, or operation of its programs, services, and activities. With regard to all aspects of this Agreement, Contractor certifies and warrants it will comply with this policy. No person may be excluded from participation in, be denied benefits of, be discriminated against in the admission or access to, or be discriminated against in treatment or employment in the City's contracted programs or activities, on the grounds of handicap and/or disability, age, race, color, religion, sex, national origin, or any other classification protected by federal or Tennessee State Constitutional or statutory law; nor may they be excluded from participation in, be denied benefits of, or be otherwise subjected to discrimination in the performance of contracts with the City or in the employment practices of the City's Contractors. Accordingly, all proposers entering into contracts with the City may upon request be required to show proof of such

nondiscrimination and to post in conspicuous places that are available to all employees and applicants, notices of nondiscrimination.

15. **Confidentiality of Records.** All educational records created, disclosed or maintained pursuant to the terms of this contract are confidential and shall be created, disclosed and maintained pursuant to the provisions of Family Educational Right to Privacy Act, also known as FERPA (20 U.S.C.A. s1232g), its regulations and Board Policy.
16. **Background Checks.** Contractor shall comply with T.C.A. §49-5-413, which requires all contractors to facilitate a criminal history records check conducted by the Tennessee Bureau of Investigation and the Federal Bureau of Investigation for each employee prior to permitting the employee to have contact with students or enter school grounds when students are present.
17. **Tobacco Free Policy.** Pursuant to Murfreesboro City School Board Policy 1.803, the use of tobacco and tobacco products, including smokeless tobacco, are prohibited on all of the Murfreesboro City School property.
18. **Gratuities and Kickbacks.** It is a breach of ethical standards for any person to offer, give or agree to give any employee or former employee, or for any employee or former employee to solicit, demand, accept or agree to accept from another person, a gratuity or an offer of employment in connection with any decision, approval, disapproval, recommendation, preparation of any part of a program requirement or a purchase request, influencing the content of any specification or procurement standard, rendering of advice, investigation, auditing or in any other advisory capacity in any proceeding or application, request for ruling, determination, claim or controversy or other particular matter, pertaining to any program requirement of a contract or subcontract or to any solicitation or proposal therewith. It is a breach of ethical standards for any payment, gratuity or offer of employment to be made by or on behalf of a subcontractor under a contract to the prime contractor or higher tier subcontractor or a person associated therewith, as an inducement for the award of a subcontract or order. Breach of the provisions of this paragraph is, in addition to a breach of this Agreement, a breach of ethical standards which may result in civil or criminal sanction and/or debarment or suspension from being a contractor or subcontractor under the City.
19. **Assignment.** The provisions of this Agreement inure to the benefit of and are binding upon the respective successors and assignees of the parties hereto. Except for the rights of money due to Contractor under this Agreement, neither this Agreement nor any of the rights and obligations of Contractor hereunder may be assigned or transferred in whole or in part without the prior written consent of the City. Any such assignment or transfer does not release Contractor from its obligations hereunder.
20. **Integration.** This Agreement sets forth the entire agreement between the parties with respect to the subject matter hereof and governs the respective duties and obligations of the parties.
21. **Force Majeure.** No party has any liability to the other hereunder by reason of any delay or failure to perform any obligation or covenant if the delay or failure to perform is occasioned by *force majeure*, meaning any act of God, storm, fire, casualty, unanticipated work stoppage, strike, lockout, labor dispute, civil disturbance, riot, war, national emergency, act of public enemy, or other cause of similar or dissimilar nature beyond its control.
22. **Governing Law and Venue.** The validity, construction and effect of this Agreement and any and all extensions or modifications thereof are governed by the laws of the state of Tennessee regardless of choice of law doctrine or provision in any attachment or other document that Contractor may provide. Any action between the parties arising from this agreement may only be filed in the courts of Rutherford County, Tennessee.

23. **Severability.** Should any provision of this Agreement be declared to be invalid by any court of competent jurisdiction, such provision will be severed and not affect the validity of the remaining provisions of this Agreement.
24. **Attorney Fees.** In the event any party takes legal action to enforce any provision of the Agreement, should the City prevail, Contractor will pay all expenses of such action including attorney fees, expenses, and costs at all stages of the litigation and dispute resolution.
25. **Iran Divestment Act of Tennessee.** By submission of the Contractor's Bid, Contractor certifies, under penalty of perjury, that to the best of its knowledge and belief that Contractor is not on the list created pursuant to Tenn. Code Ann. §12-12-106.
26. **Non-Boycott of Israel.** By submission of the Contractor's Bid, Contractor certifies, under penalty of perjury, that to the best of its knowledge and belief that each supplier is not boycotting Israel pursuant to Tenn. Code Ann. § 12-4-119 and will not boycott Israel during the term of contract. This applies to contracts of \$250,000 or more and to contractors with ten (10) or more employees.
27. **Effective Date.** This Agreement is not binding upon the parties until signed by each of the Contractor and authorized representatives of the City and is thereafter effective as of the date set forth above.

IN WITNESS WHEREOF, the parties enter into this agreement as of the Effective Date first listed above.

CITY OF MURFREESBORO, TENNESSEE

CMG CONTRACTORS, INC.

By: _____
Shane McFarland, Mayor

By: _____
Marcus Hayes, President

Approved as to form:

Adam F. Tucker, City Attorney

Exhibit A
Insurance Requirements

Contractor must, as a material obligation to the Owner and a condition precedent to any payment otherwise due to Contractor, furnish and maintain, and cause its Subcontractors to furnish and maintain, insurance in accordance with the provisions of this Exhibit.

Contractor must secure and maintain without interruption, from the date of commencement of the Work until the later of the date of Final Completion, the date of final payment, or the date until which this Agreement requires any coverage to be maintained after final payment, policies of commercial general liability, commercial auto, umbrella/excess, workers' compensation and employer's liability insurance, providing the following coverages, limits and endorsements:

1. Commercial General Liability Insurance.

The CGL policy must be written on an occurrence basis, on ISO form CG 001 or its equivalent, providing coverage for bodily injury, broad form property damage, personal injury (including coverage for contractual and employee acts), contractual liability, incidental professional liability, the hazards commonly referred to as XCU, and products and completed operations, with a combined single limit of liability of not less than \$1,000,000 for each occurrence applicable to the Work, and an annual aggregate limit of liability of not less than \$1,000,000 applicable solely to the Work, and meeting all other requirements of this Exhibit.

The general liability insurance may be accomplished with a combination of a general liability and an excess/umbrella liability policy.

Each general liability policy must be endorsed or written to:

- Include the per project aggregate endorsement;
- Name as additional insureds the following: the City of Murfreesboro and its elected officials, officers, employees, representatives and agents (collectively, the "Additional Insureds");
- Stipulate that the insurance afforded by the policies furnished by Contractor will be primary insurance and that any insurance, self-insured retention, deductibles, or risk retention programs maintained or participated in by the Additional Insureds, or their agents, officials or employees will be excess and not contributory to the liability insurance furnished by Contractor and by its Subcontractors;
- Includes a severability of interest clause; and
- Waive all rights of recovery against the Additional Insureds.

2. Workers' Compensation Insurance. Workers' Compensation policy must meet all Tennessee statutory requirements, including Employers' Liability Insurance with limits of at least \$ 1,000,000 per accident or disease per employee, both policies endorsed to waive subrogation against the Additional Insureds.

3. **Auto Liability Insurance**

Commercial auto liability must be carried with minimum combined single limit of \$1,000,000 per occurrence.

This policy must include a duty to defend and cover all owned, non-owned, leased, hired, assigned or borrowed vehicles.

This policy must be endorsed, by specific or blanket endorsement, to name the Additional Insureds as such, stipulate that any insurance carried by the Additional Insureds must be excess and not contributory, and to waive subrogation against the Additional Insureds.

4. **Term of Coverage**

The products and completed operations liability coverage required by this Agreement must extend for a period of not less than five years after the earlier of Final Payment for the Work, or the termination of the Agreement (the "Completed Operations Term").

If at any time during the Completed Operations Term Contractor cannot obtain equivalent coverage by replacement or renewal, Contractor must acquire a tail policy prior to expiration of the existing policy that will extend coverage until the end of the Completed Operations Term.

Contractor will furnish certificates of insurance and other evidence that the Owner may reasonably require during the Completed Operations Term to establish compliance with the requirements of this paragraph.

All other policies of insurance must be maintained continuously in force from commencement of the Work until the date of Final Payment.

5. **Subcontractor and Lower-Tier Entities Insurance Requirements**

Contractor must require all of Contractor's Subcontractors and must require its Subcontractors to require their Lower Tier Entities, as a condition of working on the Project, and of receiving payment, to:

Purchase and maintain Commercial General Liability, Workers' Compensation and Employer's Liability, and Automotive insurance policies, with the same coverages, endorsements, terms of coverage and other provisions as are required of Contractor under by this Exhibit, **EXCEPT THAT** the combined coverage limits of the general liability insurance to be furnished by Lower Tier Entities must be \$ 1,000,000 per occurrence, and \$ 1,000,000 as the annual aggregate limit; and

Timely furnish to the Owner proper certificates, endorsements, copies of declarations pages, and other documents necessary to establish the Subcontractor's compliance with this Exhibit.

The Lower Tier Entities' general liability policy must also be endorsed to provide the policy must be primary insurance, the general liability insurance furnished by Contractor must be the secondary and non-contributory, and any insurance carried by the Additional Insureds must be excess, tertiary and non-contributory to the insurance furnished by Contractor and Subcontractor.

The Owner has the right to inspect and copy all such certificates, endorsements, or other proof at any reasonable time.

6. **Other Policy Provisions.** Each policy to be furnished by Contractor and each Subcontractor must:

Be issued by an insurance carrier having a rating from A.M. Best Company of at least A-VII or better;

Provide that attorney's fees are outside of the policy's limits and be unlimited;

Include the Project per aggregate endorsement;

Waive all rights of subrogation against the Owner;

Provide a Certificate that contains a provision that coverages afforded under the policies will not be canceled, allowed to expire, or reduced in amount until at least thirty (30) days' prior written Notice has been given to the Owner; and

Be otherwise satisfactory to the Owner. The Owner agrees to consider alternatives to the requirements imposed by this Exhibit but only to the extent that the Owner is satisfied the insurance is not commercially available to the insured. In such event, the Owner has the right to set conditions for such waiver, including, but not limited to, additional indemnities, and the request that the Owner be a loss-payee under the policy.

7. **Certificates and Endorsements**

Within 10 days after the execution of this Agreement, Contractor must provide the Owner with certificates and endorsements;

Upon the Owner request, Contractor must provide the Owner with certificates and endorsements from each of its Subcontractors, in all cases evidencing compliance by Contractor, each Subcontractor, and Lower Tier Entities with the requirements of this Exhibit together with letters from the respective carriers (including, but not limited to, the Errors and Omissions insurance carriers) that there are no known or pending claims or incidents which have resulted in the establishment of a reserve or otherwise have reduced the amount of coverage potentially available to the Owner under the policy and that available coverage has not been reduced because of revised limits or payments made (or, in the event such representations cannot be given, Contractor, its Subcontractors, and its Lower Tier Entities must furnish the particulars thereof to the Owner.

If any of the foregoing insurance coverages are required to remain in force after Final Completion, Contractor must submit an additional certificate evidencing continuation of such coverage with its application for final payment.

8. **Reduction in Coverage.** Contractor must promptly inform the Owner of any reduction of coverage resulting from revised limits, claims paid, or both and must require its Subcontractors and Lower Tier Entities to promptly inform Contractor of same. The Owner has the right to require Contractor or the applicable Subcontractor to obtain supplemental or replacement coverage to offset such reduced coverage, at the sole cost or expense of Contractor or the applicable Subcontractor.

9. Suppliers and Materialmen Coverages

- | Contractor will endeavor to cause all suppliers and materialmen to deliver any equipment, machinery or other goods FOB Site.
- | With respect to any equipment, machinery or other goods for which the Owner or Contractor has paid a deposit, Contractor will cause the respective suppliers and materialmen to maintain personal property insurance in an amount equal to the value of such equipment, machinery or other goods (but in no event less than the amount of the applicable deposit) during fabrication, storage and transit, naming the Owner and Contractor as loss payee as their interests appear.

10. Condition Precedent to Starting Work

- | Prior to, and as a condition of its right to begin performing any Work on the Site, Contractor and each Subcontractor and Lower Tier Entities must deliver to the Owner certificates of insurance representing that the required insurance is in force, together with the additional insured endorsements and waivers of subrogation required above, and such other proof satisfactory to the Owner that the required insurance is in place; together with the original of each bond required under this Agreement. Contractor and each Subcontractor and Lower Tier Entities hereby authorize the Owner to communicate directly with the respective insurance agents, brokers and/or carriers and sureties to verify their insurance and bond coverage;
- | The Owner is under no obligation or duty to make any such inquiry and the Owner is entitled to rely on any proofs of insurance tendered by Contractor or its Subcontractors and Lower Tier Entities. The Owner's acceptance of any proof of insurance and bonds offered by Contractor or any Subcontractor or Lower Tier Entities will not be deemed a waiver of the obligations of Contractor and Subcontractors and Lower Tier Entities to furnish the insurance and bonds required by this Exhibit.

- 11. Additional Proofs of Insurance.** Contractor must, within 10 days after request, provide the Owner with certified copies of all policies and endorsements obtained in compliance with this Agreement.
- 12. Indemnity.** The fact that Contractor and its Subcontractors are required by this Agreement to purchase and maintain insurance in no way limits or restricts any other obligations or duties Contractor and its Subcontractors and Lower Tier Entities may have to indemnify, defend or hold harmless the Owner and the other Additional Insureds from and against any and all demands, liabilities, losses or expenses of whatever kind or nature.
- 13. Interpretation.** In the event of any inconsistency between the provisions of this Exhibit and those of the other provisions of the Agreement, the terms of this Exhibit will govern.

Agenda Item Title: Zone Waiver Appeal Hearing Packet 1

Board Meeting Date: May 27, 2025

Department: Student Support Services

Presented by: Trey Duke

Board Agenda Category:

Consent Agenda

Action Item

Reports and Information

Requires City Council Approval: Yes No

Summary

Murfreesboro City Schools conducted Zone Waiver Appeal Hearings on Friday, May 9, 2025.

Parents/guardians were able to submit a written appeal to the Office of Student Support Services team within ten (10) business days of receiving a waiver denial notification.

The Board appointed committee members to hear each individual appeal case. The panel's decision was either to uphold or overturn the original decision on the denial status of the zone waiver.

Staff Recommendation

Staff recommends the Board approval of the committee's decision to deny the appeal of Hearing Packet #1.

Fiscal Impact

Not Applicable

Connection to MCS's Five-Year Strategic Plan

- Known:** Every student will be *known* through whole-child programs and support.
- Safe:** Every student will be *safe* through equitable access to buildings, facilities, and infrastructure that meets their needs.
- Challenged:** Every student will be *challenged* by learning from highly effective educators and employees.
- Empowered:** Every student will be *empowered* through academic success

Agenda Item Title: Zone Waiver Appeal Hearing Packet 2

Board Meeting Date: May 27, 2025

Department: Student Support Services

Presented by: Trey Duke

Board Agenda Category:

Consent Agenda

Action Item

Reports and Information

Requires City Council Approval: Yes No

Summary

Murfreesboro City Schools conducted Zone Waiver Appeal Hearings on Friday, May 9, 2025.

Parents/guardians were able to submit a written appeal to the Office of Student Support Services team within ten (10) business days of receiving a waiver denial notification.

The Board appointed committee members to hear each individual appeal case. The panel's decision was either to uphold or overturn the original decision on the denial status of the zone waiver.

Staff Recommendation

Staff recommends the Board approval of the committee's decision to deny the appeal of Hearing Packet #2.

Fiscal Impact

Not Applicable

Connection to MCS's Five-Year Strategic Plan

- Known:** Every student will be *known* through whole-child programs and support.
- Safe:** Every student will be *safe* through equitable access to buildings, facilities, and infrastructure that meets their needs.
- Challenged:** Every student will be *challenged* by learning from highly effective educators and employees.
- Empowered:** Every student will be *empowered* through academic success

Agenda Item Title: Zone Waiver Appeal Hearing Packet 3

Board Meeting Date: May 27, 2025

Department: Student Support Services

Presented by: Trey Duke

Board Agenda Category:

Consent Agenda

Action Item

Reports and Information

Requires City Council Approval: Yes No

Summary

Murfreesboro City Schools conducted Zone Waiver Appeal Hearings on Friday, May 9, 2025.

Parents/guardians were able to submit a written appeal to the Office of Student Support Services team within ten (10) business days of receiving a waiver denial notification.

The Board appointed committee members to hear each individual appeal case. The panel's decision was either to uphold or overturn the original decision on the denial status of the zone waiver.

Staff Recommendation

Staff recommends the Board approval of the committee's decision to deny the appeal of Hearing Packet #3.

Fiscal Impact

Not Applicable

Connection to MCS's Five-Year Strategic Plan

- Known:** Every student will be *known* through whole-child programs and support.
- Safe:** Every student will be *safe* through equitable access to buildings, facilities, and infrastructure that meets their needs.
- Challenged:** Every student will be *challenged* by learning from highly effective educators and employees.
- Empowered:** Every student will be *empowered* through academic success

COMPARISON OF BUDGET TOTALS
July 1, 2024 Through March 31, 2025

TOTAL INCOME	7/1/24 – 3/31/25	\$ 83,760,180
TOTAL EXPENSES	7/1/24 – 3/31/25	<u>74,929,085</u>
NET INCOME	3/31/25	\$ <u>8,831,095</u>

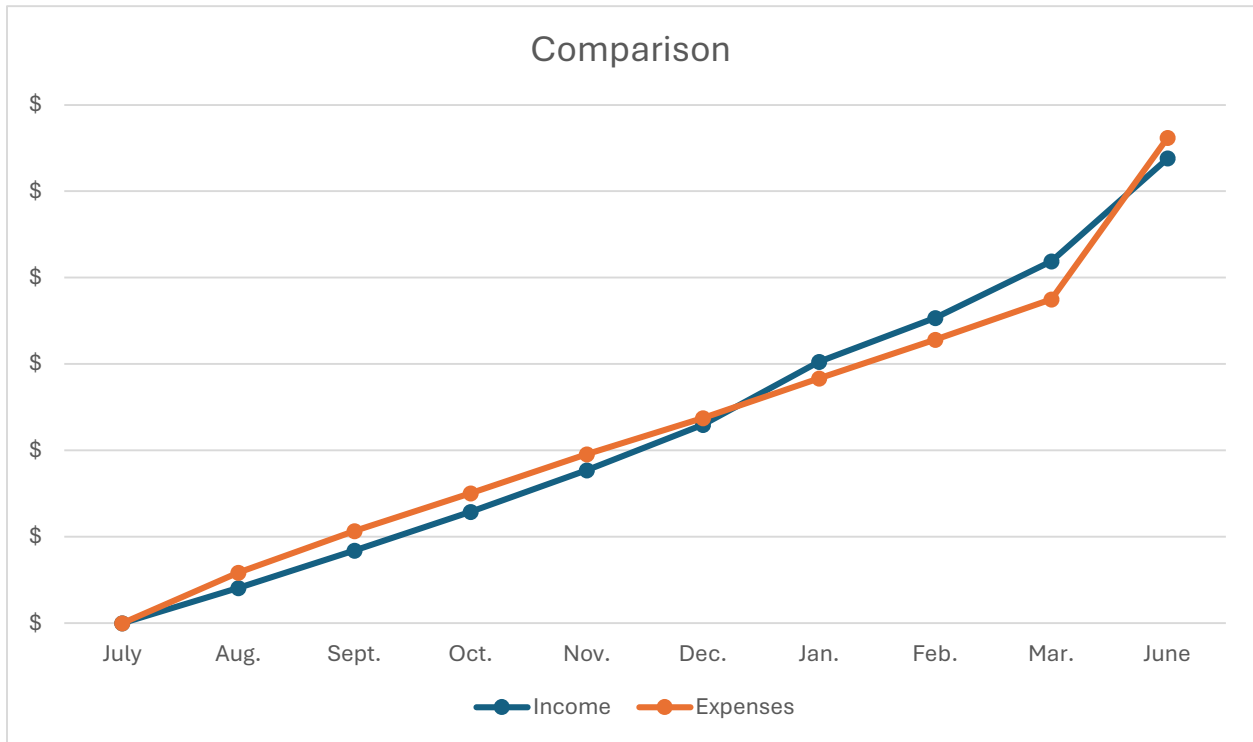

YEAR-TO-DATE REVENUE COMPARISON

BUDGET CLASS.	2023-24 BUDGET	2023-24 YTD REV.	2023-24 OVR/(UNDR) BUDGET	2023-24 % Received	2024-25 BUDGET	2024-25 YTD REV.	2024-25 OVR/(UNDR) BUDGET	2024-25 % Received
40110-Current Prop. Tax	15,000,000	12,399,734	(2,600,266)	82.7%	15,000,000	11,892,409	(3,107,591)	79.3%
40210-Local Option Sales Tax	14,300,000	10,312,936	(3,987,064)	72.1%	16,700,000	10,726,428	(5,973,572)	64.2%
40000-41110-Other County Rev	1,761,800	1,014,933	(746,867)	57.6%	1,972,000	890,681	(1,081,319)	45.2%
43300-44000-Other Local Revenue (Interest, Tuition)	998,638	870,780	(127,858)	87.2%	869,936	1,320,605	450,669	151.8%
SUBTOTAL LOCAL REVENUE	\$ 32,060,438	\$ 24,598,384	(\$ 7,462,054)	-	\$ 34,541,936	\$ 24,830,123	(\$ 9,711,813)	71.9%
46310-Project Diabetes Grant	93,900	120	(93,780)	0.1%	126,700	125,200	(1,500)	98.8%
46510-TISA	59,713,965	48,316,215	(11,397,750)	80.9%	63,477,651	51,371,129	(12,106,522)	80.9%
46515-Early Childhood Ed. (VPK Grant)	1,326,895	600,711	(726,184)	45.3%	1,500,605	958,251	(542,354)	63.9%
46590-Other State Education (Summer Learning Grant)	-	-	-	N/A	1,779,702	-	(1,779,702)	0
46610-Career Ladder Program	56,000	36,640	(19,360)	65.4%	51,000	28,971	(22,028)	56.8%
46591-Coordinated School Health (ended FY23)	-	-	-	N/A	-	-	-	N/A
46595-Family Resource (ended FY23)	-	-	-	N/A	-	-	-	N/A
46800-46990-Safe Schools Grant (ends 12/31/23)	523,542	424,818	(98,724)	81.1%	150,000	-	(150,000)	0.0%
SUBTOTAL STATE REVENUES	\$ 61,714,302	\$ 49,378,504	(\$ 12,335,798)	-	\$ 67,085,658	\$ 52,483,551	(\$ 14,602,106)	78.2%
47000- Federal Funds	24,000	-	(24,000)	0.0%	468,555	-	(468,555)	0.0%
SUBTOTAL FEDERAL REVENUES	\$ 24,000	-	(\$ 24,000)	-	\$ 468,555	\$ -	(\$ 468,555)	0.0%
49100-49800 Insurance Recovery/Indirect Costs	460,000	25,224	(434,776)	5.5%	195,000	197,305	2,305	101.2%
49810-City of Murfreesboro Allocation	7,885,103	5,913,827	(1,971,276)	75.0%	7,885,103	5,913,827	(1,971,276)	75.0%
49820-City TN All Corp Grant	165,435	165,435	-	100.0%	156,000	156,000	-	100.0%
SUBTOTAL OPERATING TRANSFERS	\$ 8,510,538	\$ 6,104,486	(\$ 2,406,052)	-	\$ 8,236,103	\$ 6,267,132	(\$ 1,968,971)	92.1%
TOTAL REVENUES	\$ 102,309,278	\$ 80,081,374	(\$ 22,227,904)	78.3%	\$ 110,332,252	\$ 83,580,806	(\$ 26,751,445)	75.8%

YEAR-TO-DATE EXPENDITURE COMPARISON

MARCH 2025

PAGE 1

	BUDGET CLASS.	2023-24 BUDGET	2023-24 YTD EXP.	2023-24 OVR/(UNDR) BUDGET	2023-24 %	2024-25 BUDGET	2024-25 YTD EXP.	2024-25 OVR/(UNDR) BUDGET	2024-25 %
1	71100-Reg. Instruction	57,249,035	36,466,189	20,782,845	63.7%	61,169,757	39,057,156	(22,112,601)	63.9%
2	71200-Sp. Ed. Instruction	12,674,470	8,086,375	4,588,095	63.8%	13,630,829	8,933,518	(4,697,311)	65.5%
3	71400-Student Body Ed.	-	-	-	N/A	-	-	-	N/A
4	72110-Attendance	160,965	115,313	(45,652)	71.6%	180,600	133,809	(46,791)	74.1%
5	72120-Health Services	1,098,216	590,733	(507,482)	53.8%	1,252,495	804,277	(448,218)	64.2%
6	72130-Guidance	3,623,785	2,366,261	(1,257,524)	65.3%	4,188,625	2,751,249	(1,437,376)	65.7%
7	72210-Reg. Instr. Support	2,548,064	1,659,900	(888,164)	65.1%	2,733,798	1,867,249	(866,549)	68.3%
8	72220-Sp. Ed. Support	1,999,863	1,205,830	(794,032)	60.3%	2,087,055	1,458,486	(628,569)	69.9%
9	72250-Technology	2,674,265	1,798,380	(875,884)	67.3%	2,738,190	1,981,795	(756,394)	72.4%
10	72310-Bd. Of Education	1,966,681	1,488,445	(478,235)	75.7%	2,086,320	1,768,309	(318,011)	84.8%
11	72320-Office of Supt.	440,109	288,002	(152,107)	65.4%	471,438	320,858	(150,579)	68.1%
12	72410-Office of Principal	5,703,089	3,917,711	(1,785,377)	68.7%	6,110,248	4,222,110	(1,888,137)	69.1%
13	72510-Fiscal Services	886,045	637,439	(248,605)	71.9%	861,755	660,673	(201,081)	76.7%
14	72520-Personnel Services	594,415	426,012	(168,403)	71.7%	596,835	440,870	(155,964)	73.9%
15	72610-Oper. Of Plant	6,402,482	3,950,047	(2,452,434)	61.7%	6,327,847	4,059,140	(2,268,707)	64.2%
16	72620-Maint. Of Plant	4,608,543	2,174,666	(2,433,877)	47.2%	3,259,108	1,971,757	(1,287,351)	60.5%
17	72710-Pupil Transp.	4,544,354	2,659,164	(1,885,189)	58.5%	5,436,402	3,299,440	(2,136,962)	60.7%
18	73300-Community Service	522,655	359,440	(163,214)	68.8%	507,561	313,314	(194,246)	61.7%
19	73400-Early Childhood Educ.	1,108,368	703,330	(405,038)	63.5%	1,142,547	712,862	(429,684)	62.4%
20	76100-Reg. Cap. Outlay	171,872	138,114	(33,758)	80.4%	3,243,219	32,254	(3,210,964)	1.0%
21	82130-Education Debt Serv.	-	-	-	N/A	-	-	-	N/A
22	99100-Operating Transfers	217,610	139,959	(77,651)	64.3%	217,601	139,959	(77,642)	64.3%
	TOTALS	109,194,886	69,171,310	\$ 10,718,314	65.4%	118,242,230	74,929,085	(\$ 43,313,137)	64.6%

Period 7

Enrollment Update

April 11 - May 12, 2025



Enrollment for Pre-Kindergarten Through Grade 6

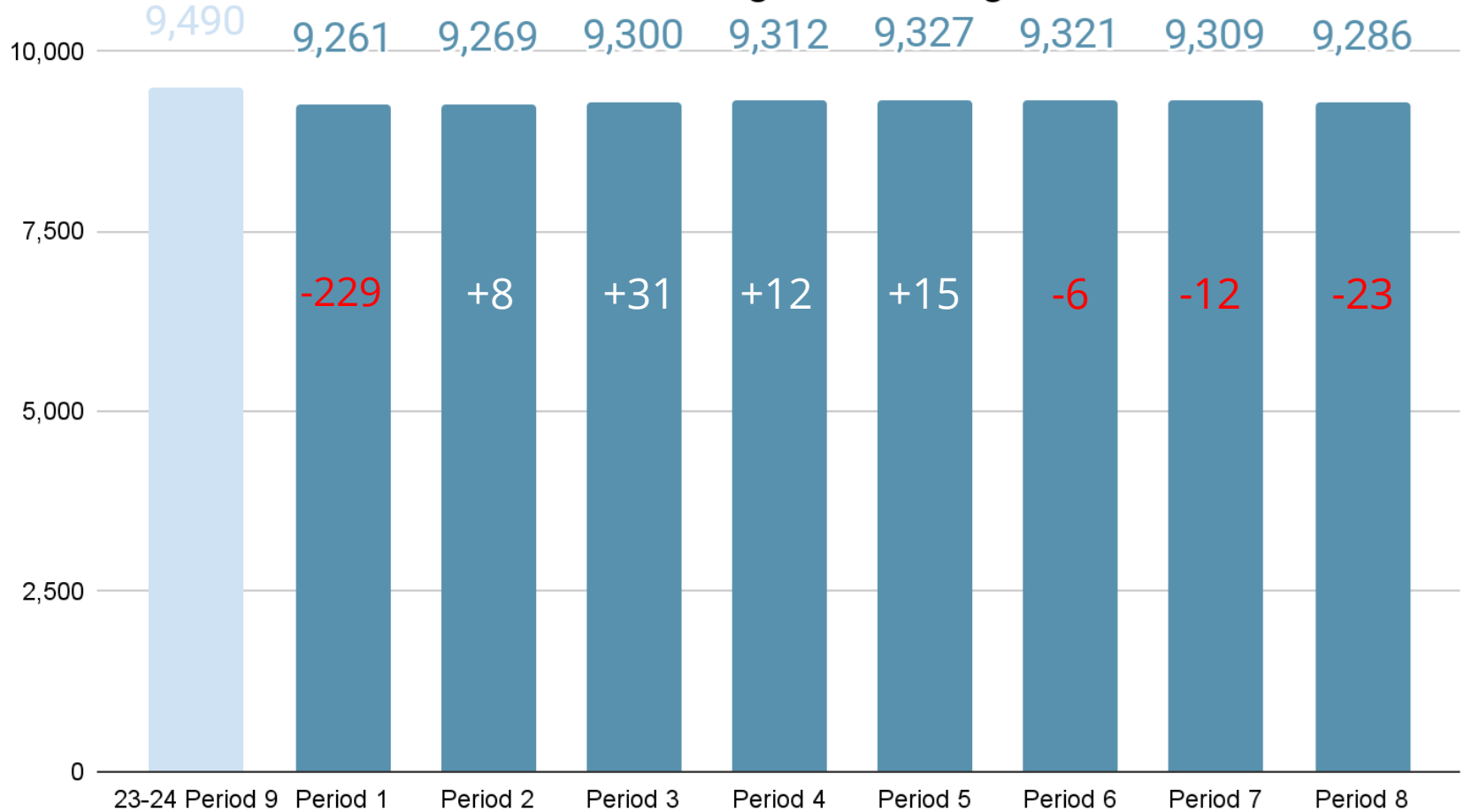

Last year at Period 8 was 9,492 or -206 to now

Average Daily Attendance Rate

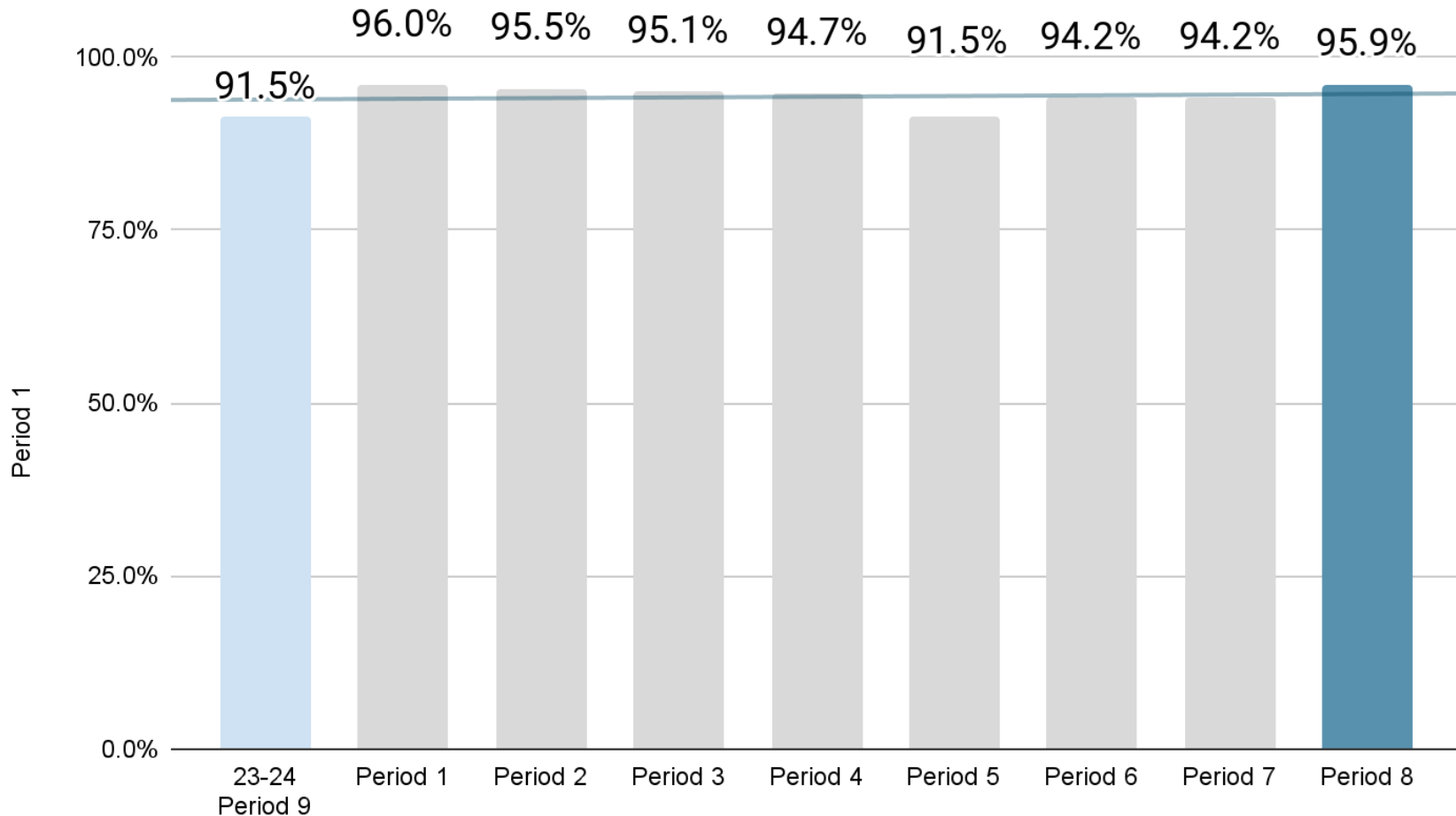

Last year at Period 8: 95.3%

Truancy

10+ Days Unexcused Absences

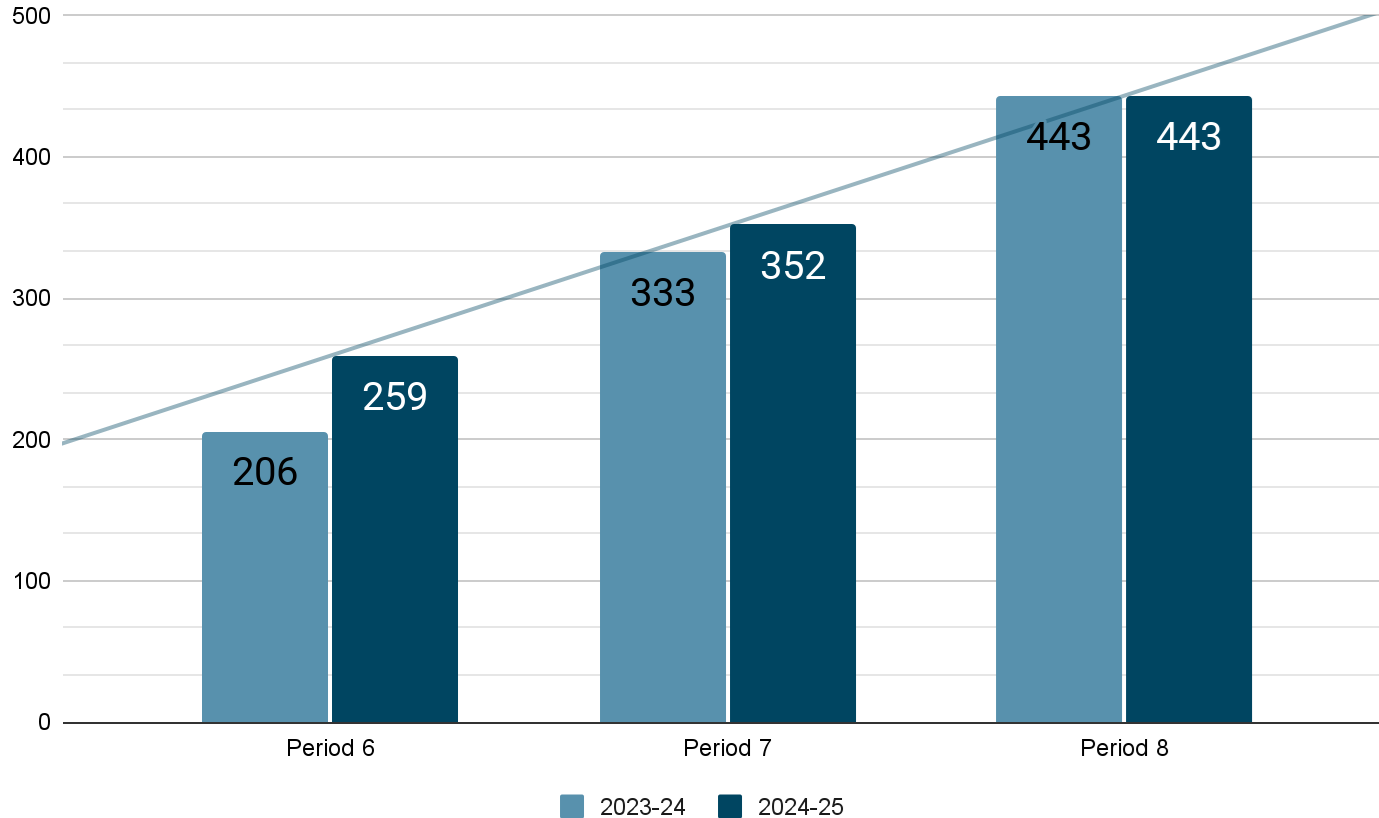

Chronic Absenteeism

Missing 10% or more (Excused and Unexcused)

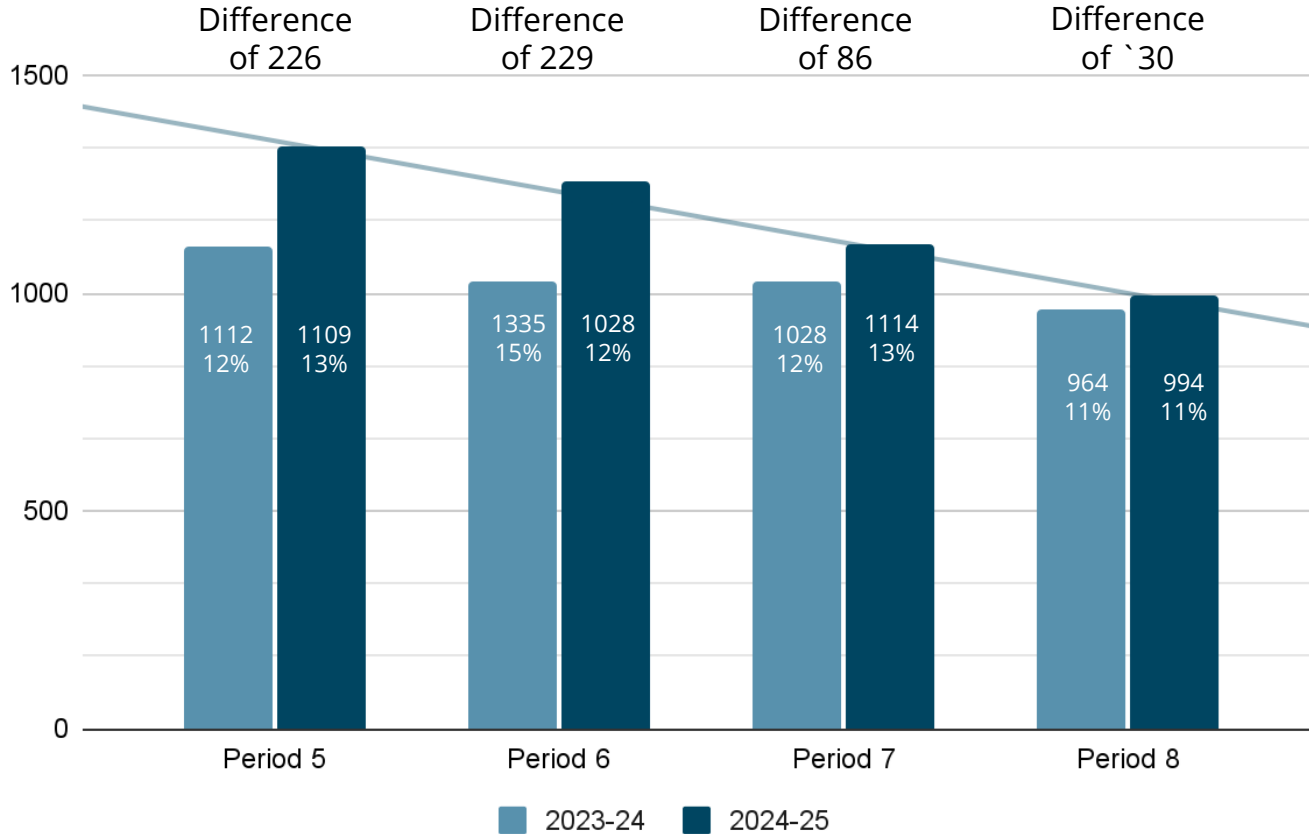

Regular Education Pupil-Teacher Ratio (PTR)	Pupils	Teachers	PTR	PTR % Change from Previous Period
Kindergarten through 3rd Grade	5,570	300	18.57	-0.09
4th Grade through 6th Grade	3,066	163	18.81	+0.04
District Totals	8,636	463	18.73	-0.1

Two-Year Comparison: Average Daily Absences

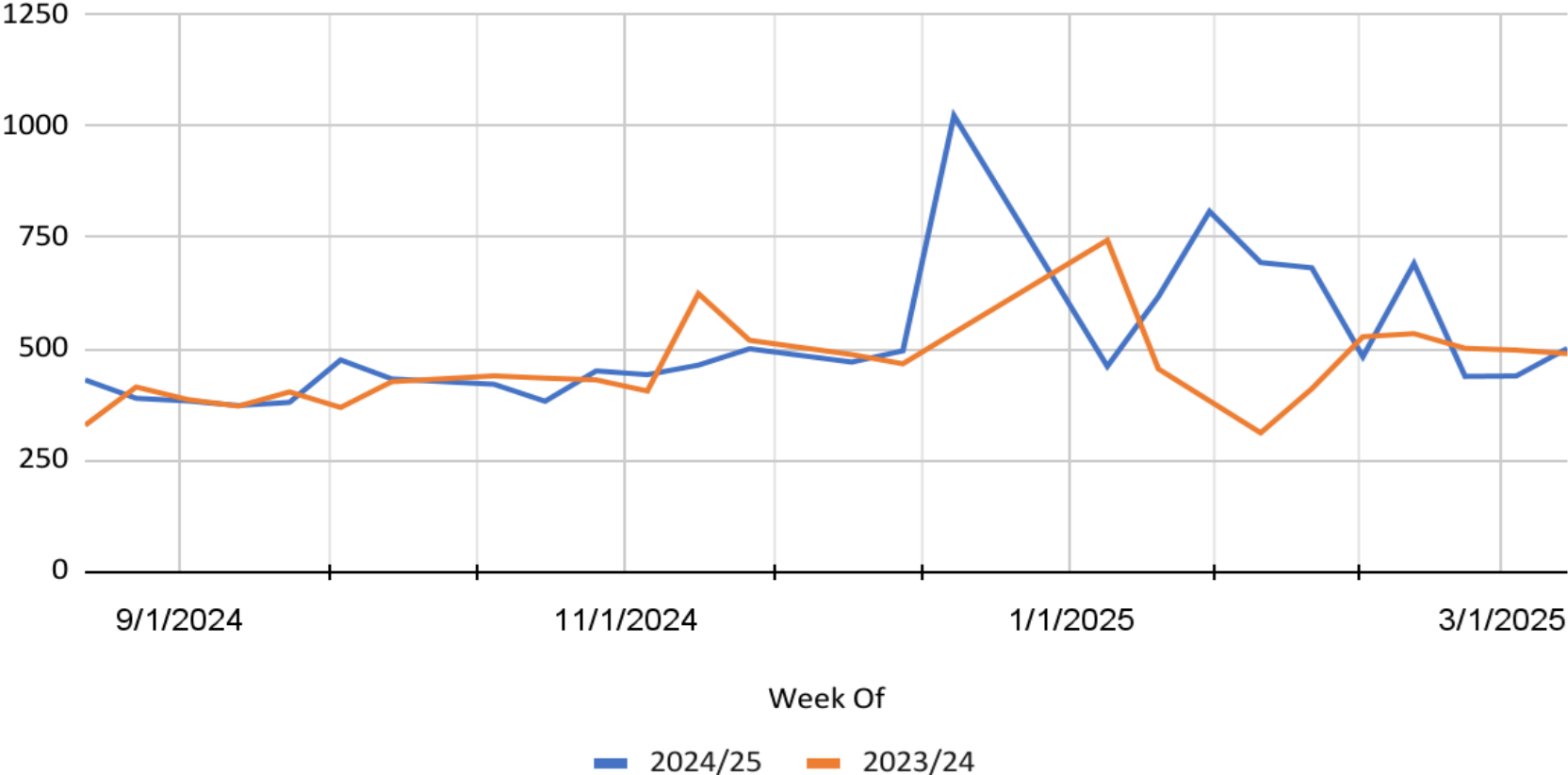

Questions



Enrollment Period 8 -04/12/2025 - 05/12/2025

	K-6 Gen Ed Totals	PS VPK	PS SpEd	PS Peers	CDC	BEST	Deaf Ed	TOTALS	Gain/ Loss from Per 7
Black Fox	808	40			29			877	(7)
Bradley	342							342	(4)
Cason Lane	672	80	42	21	33			848	4
Discovery	387							387	0
Erma Siegel	795		14	16	23		3	851	2
Hobgood	636				11			647	(9)
John Pittard	729	40	15	12	20			816	2
Mitchell-Neilson	530	39	15	10		28		622	(2)
Northfield	607	40	8	6	26			687	(3)
Overall Creek	942				16			958	(1)
Reeves-Rogers	339				14			353	(1)
Salem	937				19			956	0
Scales	912				30			942	(4)
								9286	(23)

Totals	8636	239	94	65	221	28	3	9286
	K-6 Gen Ed Total	PS VPK	PS SpEd	PS Peers	CDC	BEST	Deaf Ed	
TISA Funded	8636				221	28	3	8888
Non-TISA Funded		239	94	65				398

Total Growth Over Period 9 23-24	
Period 9 2023-2024 -----	9490
Growth from 23-24 to 24-25 ---	-204

TISA Funded Growth Over Period 9 23-24	
Period 9 2023-2024 -----	9064
Growth from 23-24 to 24-25 ---	-176

TISA Funded Growth by Reporting Period	
Period 8 2023-2024 -----	9066
Growth from 23-24 to 24-25 ---	-178

Average Attendance Percentage	
95.9%	

PTR Period 8 -04/12/2025 - 05/12/2025

	Kindergarten			1st Grade			2nd Grade			3rd Grade			Total	Total	K-3 PTR	4th Grade			5th Grade			6th Grade			Total	Total	4-6 PTR	Total K-6	Gain/Loss from Per 7
	P	#	PTR	P	#	PTR	P	#	PTR	P	#	PTR	Pupils	Teachers	Ratio	P	#	PTR	P	#	PTR	P	#	PTR	Pupils	Teachers	Ratio		
Black Fox	135	7	19.29	115	6	19.17	118	6	19.67	142	8	17.75	510	27	18.89	107	6	17.83	106	5	21.20	85	4	21.25	298	15	19.87	808	(8)
Bradley	52	3	17.33	49	3	16.33	56	3	18.67	49	3	16.33	206	12	17.17	43	3	14.33	56	3	18.67	37	2	18.50	136	8	17.00	342	(4)
Cason Lane	99	6	16.50	109	6	18.17	123	7	17.57	116	6	19.33	447	25	17.88	91	5	18.20	104	6	17.33	30	2	15.00	225	13	17.31	672	4
Discovery	60	3	20.00	59	3	19.67	59	3	19.67	59	3	19.67	237	12	19.75	64	3	21.33	66	3	22.00	20	1	20.00	150	7	21.43	387	0
Erma Siegel	117	7	16.71	132	7	18.86	128	7	18.29	154	8	19.25	531	29	18.31	127	6	21.17	137	7	19.57				264	13	20.31	795	2
Hobgood	94	5	18.80	108	6	18.00	99	5	19.80	92	5	18.40	393	21	18.71	104	5	20.80	86	4	21.50	53	3	17.67	243	12	20.25	636	(9)
John Pittard	96	5	19.20	114	7	16.29	119	6	19.83	119	6	19.83	448	24	18.67	110	6	18.33	111	6	18.50	60	3	20.00	281	15	18.73	729	2
Mitchell-Neilson	91	5	18.20	76	5	15.20	102	5	20.40	75	4	18.75	344	19	18.11	81	5	16.20	73	4	18.25	32	2	16.00	186	11	16.91	530	(1)
Northfield	103	5	20.60	95	5	19.00	96	5	19.20	100	6	16.67	394	21	18.76	78	5	15.60	103	5	20.60	32	2	16.00	213	12	17.75	607	(3)
Overall Creek	130	7	18.57	166	8	20.75	151	8	18.88	175	9	19.44	622	32	19.44	163	8	20.38	157	8	19.63				320	16	20.00	942	(1)
Reeves-Rogers	72	4	18.00	54	4	13.50	50	3	16.67	54	3	18.00	230	14	16.43	53	4	13.25	56	3	18.67				109	7	15.57	339	(1)
Salem	141	8	17.63	129	7	18.43	155	8	19.38	171	8	21.38	596	31	19.23	151	8	18.88	153	8	19.13	37	2	18.50	341	18	18.94	937	0
Scales	145	8	18.13	142	8	17.75	160	8	20.00	165	9	18.33	612	33	18.55	134	8	16.75	166	8	20.75				300	16	18.75	912	(4)
Totals by Grade	1335	73	18.29	1348	75	17.97	1416	74	19.14	1471	78	18.86				1306	72	18.14	1374	70	19.63	386	21	18.38				8636	(23)
																												Total K-6	

Regular Education PTR			
Kindergarten thru Third Grade -----	5570	300	18.57
Fourth Grade thru Sixth Grade -----	3066	163	18.81
District Totals	8636	463	18.65

TRUANCY 10+ Days (Unexcused Absences)

	Period 1		Period 2		Period 3		Period 4		Period 5		Period 6		Period 7		Period 8		Period 9	
	24-25	23-24	24-25	23-24	24-25	23-24	24-25	23-24	24-25	23-24	24-25	23-24	24-25	23-24	24-25	23-24	24-25	23-24
Black Fox	1	-	1	-	3	1	6	5	10	6	14	9	16	16	22	20		22
Bradley	1	-	1	1	3	1	3	1	6	1	10	5	17	7	20	9		12
Cason Lane	1	-	2	1	5	4	11	6	19	18	20	29	33	55	45	65		87
Discovery	-	-	-	-	-	-	1	-	2	1	2	-	-	1	2	1		1
Erma Siegel	-	-	-	-	-	-	2	1	6	5	6	7	6	15	8	21		32
Hobgood	-	-	1	1	2	-	7	7	31	15	46	20	57	33	70	41		64
John Pittard	3	1	7	2	14	6	19	14	40	28	55	40	71	58	82	74		103
Mitchell-Neilson	-	-	-	-	4	3	5	12	17	21	25	25	34	42	37	54		85
Northfield	1	-	1	2	1	3	2	3	8	4	8	5	10	11	12	21		43
Overall Creek	-	-	-	4	-	2	-	2	1	4	-	4	2	4	8	6		14
Reeves-Rogers	-	1	2	2	3	6	8	10	22	18	19	20	27	24	35	39		53
Salem	-	-	4	1	7	4	17	10	29	21	37	35	47	54	57	69		86
Scales	-	-	-	-	1	2	3	4	11	7	17	7	32	13	45	23		45
Total Students	7	2	19	14	43	32	84	75	202	149	259	206	352	333	443	443	0	647

Chronic Absenteeism = missing 10% or more (Excused and Unexcused)

	Period 1 (2+ days)		Period 2 (4+ days)		Period 3 (6+ days)		Period 4 (8+ days)		Period 5 (10+ days)		Period 6 (12+ days)		Period 7 (14 + days)		Period 8 (16+ days)		Period 9 (18+ days)	
	24-25	23-24	24-25	23-24	24-25	23-24	24-25	23-24	24-25	23-24	24-25	23-24	24-25	23-24	24-25	23-24	24-25	23-24
Black Fox	161	170	132	129	87	97	108	100	124	98	121	91	101	91	97	86		73
Bradley	63	75	39	49	28	38	44	29	46	32	47	34	43	33	38	29		26
Cason Lane	146	161	134	113	84	100	96	103	120	109	106	93	99	100	99	96		86
Discovery	51	30	32	16	19	10	23	14	24	16	22	12	15	10	14	8		5
Erma Siegel	107	109	72	71	37	55	59	47	77	49	68	58	50	49	39	44		38
Hobgood	152	151	116	119	76	130	109	123	146	133	134	121	123	123	110	117		108
John Pittard	168	142	117	112	85	101	102	100	133	95	113	91	102	97	79	96		81
Mitchell-Neilson	167	136	140	120	109	117	120	116	135	114	128	107	117	109	106	99		90
Northfield	132	126	94	113	62	89	78	73	104	78	90	72	82	71	66	72		70
Overall Creek	153	163	111	111	82	92	89	95	85	93	91	74	79	69	71	61		49
Reeves-Rogers	105	78	84	67	73	66	73	67	95	68	83	66	80	60	75	56		53
Salem	162	141	120	114	79	107	94	97	106	95	106	94	99	99	83	91		79
Scales	187	153	163	141	101	138	117	133	140	129	145	115	124	117	117	109		93
District Total	1754	1635	1354	1275	922	1140	1112	1097	1335	1109	1254	1028	1114	1028	994	964	-	851
Internal %	20%	19%	15%	14%	10%	13%	13%	12%	15%	13%	14%	12%	13%	12%	11%	11%	-	10%